

# GENERAL INSTRUMENTS

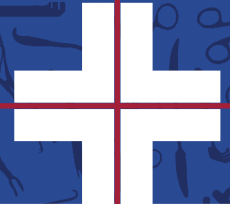

## SECTION A

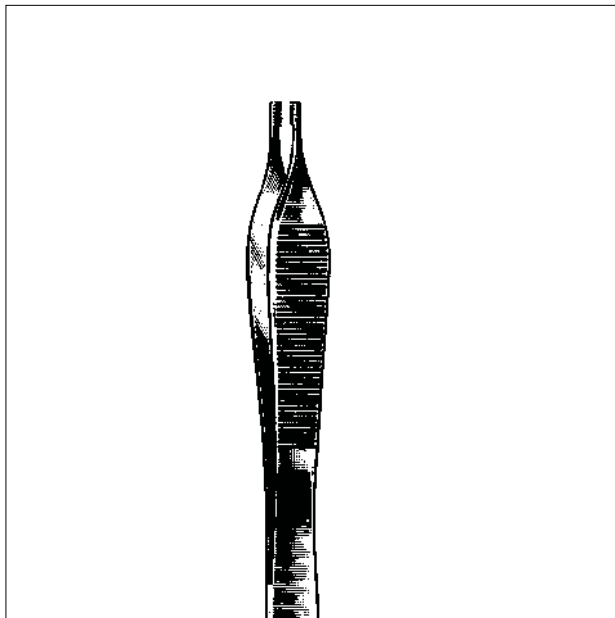

To dissect, hold, clamp, manipulate and suture soft tissue.

**ORTHO+MED**  
The Surgical Instrument Specialists

### CONTENTS

Super Cut Scissors	1-3
Operating Scissors	4-7
Dissecting Scissors	4-9
Suture scissors	9-10
Tungsten Carbide Scissors	11-12
Bandage Scissors	13
Utility Scissors/Wire Scissors	14-15
Hemostatic Forceps	15-19
Intestinal Forceps	20-21
Tubing and Utility Forceps	21-20
Towel and Sponge Forceps	22-23
Dressing & Tissue Forceps	23-27
Splinter Forceps	28-29
Needle Holders	29-32
Suction Tubes	33-34
Scalpel Handles	34-35
Probes/Suture Instruments	36-38
Bi-Polar Instruments	38

**SUPER-CUT SCISSORS**

Super-Cut Scissors represent a truly remarkable advance in scissors technology. Using the finest surgical steel, the latest heat treating methods and master craftsmanship, the upper blade of the scissors is ground to a razor-sharp edge. This process creates scissors with an unprecedented smooth and effective cutting action.

**Benefits of Super-Cut Scissors:**

- Cut through soft and fibrous tissue without effort.
- Superb control permits precision in dissection.
- Less hand fatigue for the surgeon and less trauma for the patient.
- Retain sharpness longer than ordinary scissors.
- Ring handles are black-coated for easy identification.
- Fully autoclavable.
- Backed by OrthoMed's lifetime guarantee.
- Not recommended for fiberglass or plaster splints.

Surgeons who use our Super-Cut Scissors are convinced of their superior performance and won't do without them on their surgical trays.

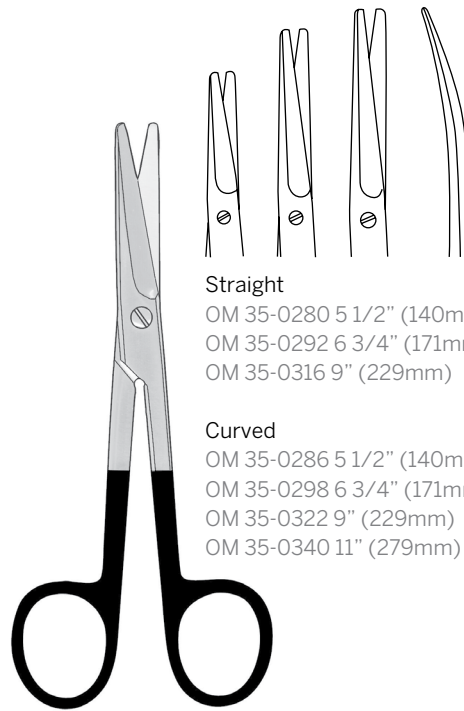

**Straight**  
 OM 35-0280 5 1/2" (140mm)  
 OM 35-0292 6 3/4" (171mm)  
 OM 35-0316 9" (229mm)

**Curved**  
 OM 35-0286 5 1/2" (140mm)  
 OM 35-0298 6 3/4" (171mm)  
 OM 35-0322 9" (229mm)  
 OM 35-0340 11" (279mm)

**SUPER-CUT MAYO SCISSORS**

Beveled blades, blunt points

*Flat, blunt scissors for dissecting soft tissue.*



**Straight**  
 OM 35-0364  
 4 1/2" (114mm)  
 blunt points

**Curved**  
 OM 35-0370  
 4 1/2" (114mm)  
 blunt points

**SUPER-CUT BABY METZENBAUM SCISSORS**

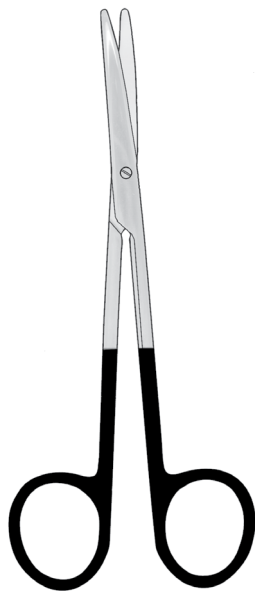

**SUPER-CUT METZENBAUM SCISSORS**

Blunt point

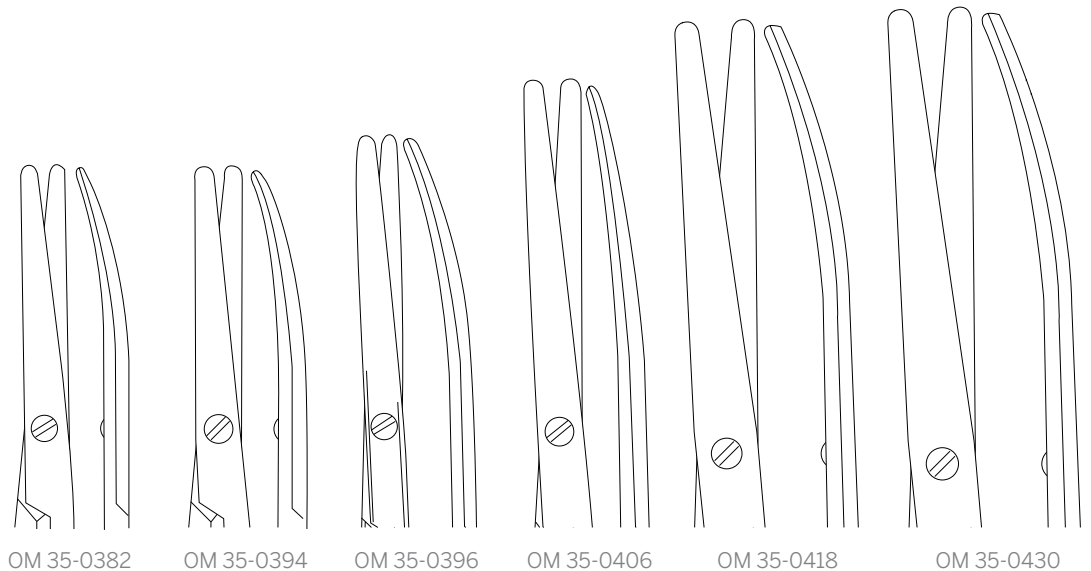

**Straight**  
 OM 35-0380 6" (152mm)  
 OM 35-0392 7" (171mm)

**Curved**  
 OM 35-0382 6" (152mm)  
 OM 35-0394 7" (178mm)  
 OM 35-0396 7" (178mm)  
 OM 35-0406 8" (203mm)  
 OM 35-0418 9" (229mm)  
 OM 35-0430 11" (279mm)

delicate

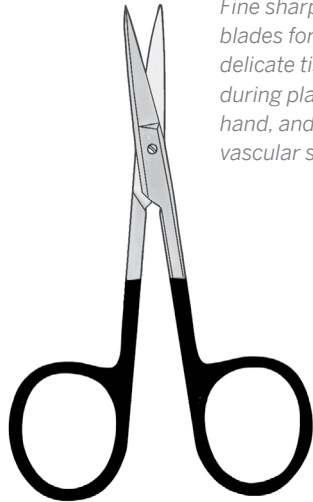

*Fine sharp/sharp blades for cutting delicate tissue during plastic, hand, and minor vascular surgery.*

**SUPER-CUT IRIS SCISSORS**  
Sharp points

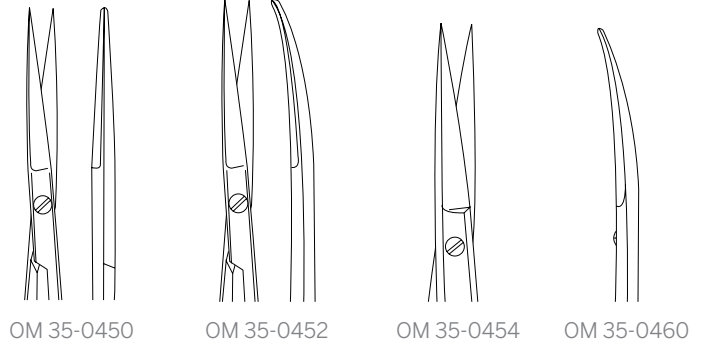

**Straight**  
OM 35-0450 3 1/2" (89mm) delicate  
OM 35-0454 4 1/2" (114mm)

**Curved**  
OM 35-0452 3 1/2" (89mm) delicate  
OM 35-0460 4 1/2" (114mm)

*Delicate short narrow tips for dissecting fine tissue.*

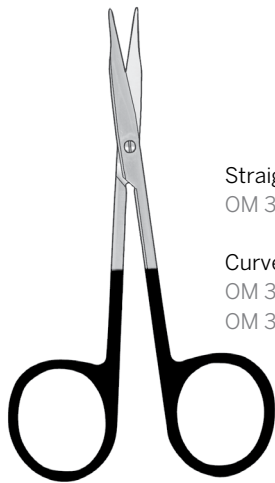

**SUPER-CUT STEVENS SCISSORS**  
Blunt points

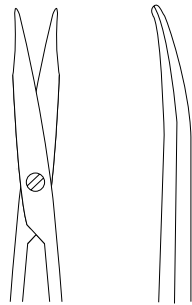

**Straight**  
OM 35-0484 4 1/2" (114mm)

**Curved**  
OM 35-0490 4 1/2" (114mm)  
OM 35-0494 5 1/4" (133mm)

*Very delicate blunt scissors with long handles for fine tissue dissection.*

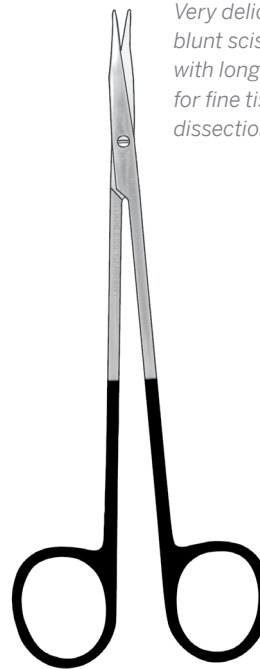

**SUPER-CUT JAMISON SCISSORS**  
6 1/4" (159mm)



OM 35-0496 curved blunt points very delicate

OrthoMed developed these remarkably sharp scissors in response to the demands of doctors, nurses, and other O.R. personnel.

Hospital tests show that these scissors cut multiple layers of stockinette bandages, drapes, and moleskin with ease.

- Very little strength is required for cutting, putting less strain on thumb and forearm.
- Perfect cutting control because you don't have to force them to cut.
- Scissors cut faster, saving critical time in the O.R.
- Retain their sharpness longer than ordinary scissors.
- Not recommended for cutting plaster.

*The delicate offset shanks and the sharp Super-Cut edge provide better leverage. The fine knob slides easily under finger and toe bandages.*



OM 35-0202  
5 1/2" (140mm)  
shanks angled on side

**SUPER-CUT HI-LEVEL BANDAGE SCISSORS**

*Cuts bandages and multiple layers of dressing with ease. Razor-sharp blades reduce hand fatigue.*



OM 35-0210    OM 35-0212

OM 35-0210  
5 1/2" (140mm)  
stainless

OM 35-0212  
7 1/4" (184mm)  
stainless

**SUPER-CUT LISTER BANDAGE SCISSORS**

*All the benefits of our Super-Cut Lister Scissors plus an oversized finger ring, which helps relieve pressure on the third metacarpal.*

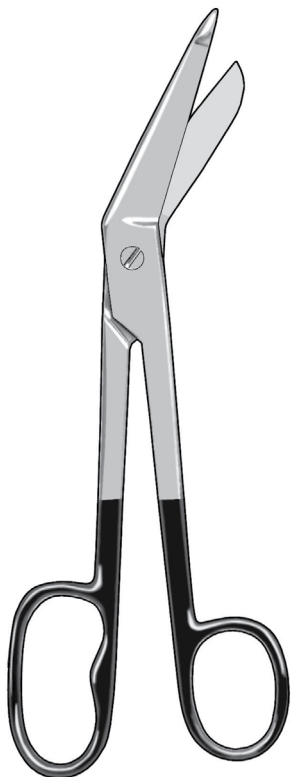

OM 35-0214  
8" (203 mm)  
stainless

**SUPER-CUT LISTER BANDAGE SCISSORS WITH LARGE FINGER RING**

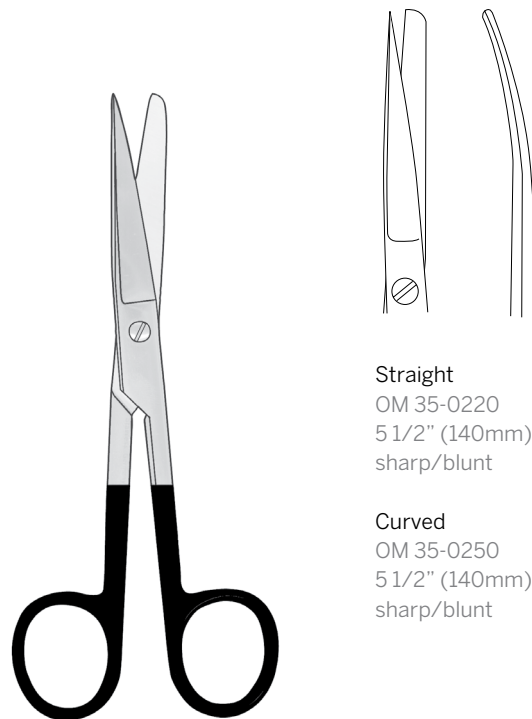

Straight  
OM 35-0220  
5 1/2" (140mm)  
sharp/blunt

Curved  
OM 35-0250  
5 1/2" (140mm)  
sharp/blunt

**SUPER-CUT OPERATING SCISSORS**

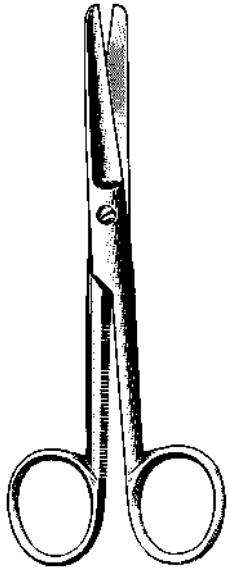

**OPERATING SCISSORS**



OM 33-0470    OM 33-0472



OM 33-0474

**Straight**

- OM 33-0300 4 1/2" (114mm) sharp/blunt
- OM 33-0302 4 1/2" (114mm) sharp/sharp
- OM 33-0304 4 1/2" (114mm) blunt/blunt
- OM 33-0310 5" (127mm) sharp/blunt
- OM 33-0312 5" (127mm) sharp/sharp
- OM 33-0314 5" (127mm) blunt/blunt
- OM 33-0320 5 1/2" (140mm) sharp/blunt
- OM 33-0322 5 1/2" (140mm) sharp/sharp
- OM 33-0324 5 1/2" (140mm) blunt/blunt
- OM 33-0370 6 1/2" (165mm) sharp/blunt
- OM 33-0372 6 1/2" (165mm) sharp/sharp
- OM 33-0374 6 1/2" (165mm) blunt/blunt

**Curved**

- OM 33-0470 4 1/2" (114mm) sharp/blunt
- OM 33-0472 4 1/2" (114mm) sharp/sharp
- OM 33-0474 4 1/2" (114mm) blunt/blunt
- OM 33-0482 5" (127mm) sharp/blunt
- OM 33-0484 5" (127mm) sharp/sharp
- OM 33-0486 5" (127mm) blunt/blunt
- OM 33-0490 5 1/2" (140mm) sharp/blunt
- OM 33-0492 5 1/2" (140mm) sharp/sharp
- OM 33-0494 5 1/2" (140mm) blunt/blunt
- OM 33-0520 6 1/2" (165mm) sharp/blunt
- OM 33-0522 6 1/2" (165mm) sharp/sharp
- OM 33-0524 6 1/2" (165mm) blunt/blunt

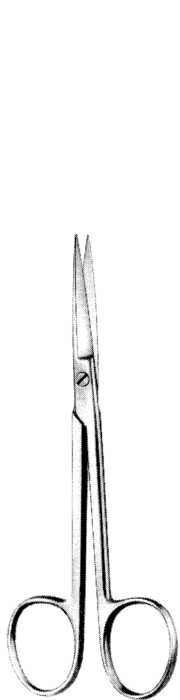

**PLASTIC SURGERY SCISSORS**  
4 3/4" (121mm)



OM 33-0532    OM 33-0538

**Straight**

- OM 33-0532 sharp/sharp
- OM 33-0534 sharp/blunt
- OM 33-0536 blunt/blunt

**Curved**

- OM 33-0538 sharp/sharp
- OM 33-0540 sharp/blunt
- OM 33-0542 blunt/blunt

**Angled on side**

- OM 33-0544 sharp/sharp

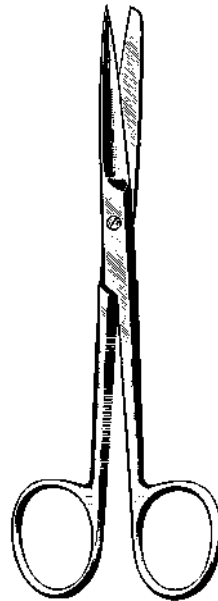

**DEAVER SCISSORS**  
5 1/2" (140mm)



OM 34-0142

*Most scissors can be serrated upon request.*

**Straight**

- OM 34-0140 sharp/blunt
- OM 34-0142 sharp/sharp

**Curved**

- OM 34-0150 sharp/blunt
- OM 34-0152 sharp/sharp



**Straight**  
 OM 53-0330 6" (152mm)  
 OM 53-0332 7" (179mm)

**Curved**  
 OM 53-0331 6" (152mm)  
 OM 53-0333 7" (179mm)

**REYNOLDS SCISSORS**  
 blunt points

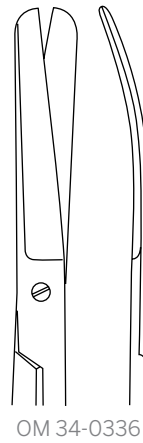
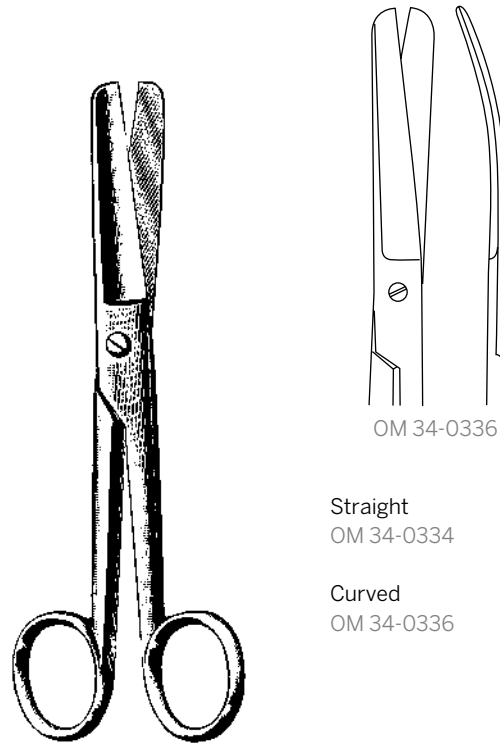

**Straight**  
 OM 34-0334

**Curved**  
 OM 34-0336

**DOYEN ABDOMINAL SCISSORS**  
 7" (178mm)

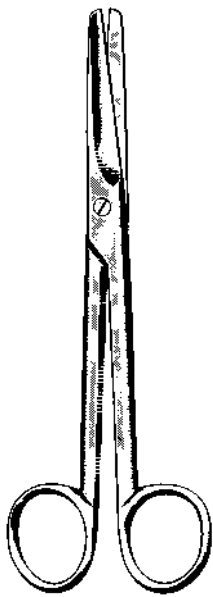

**Straight**  
 OM 34-0256 5 1/2" (140mm)  
 OM 34-0260 6 3/4" (171mm)  
 OM 34-0292 9" (229mm)

**Curved**  
 OM 34-0258 5 1/2" (140mm)  
 OM 34-0262 6 3/4" (171mm)  
 OM 34-0294 9" (229mm)

**Serrated**  
 OM 34-0280 6 3/4" (171mm)  
 OM 34-0282 6 3/4" (171mm)

**MAYO SCISSORS**  
 Beveled blades

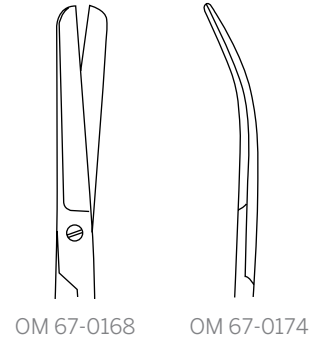
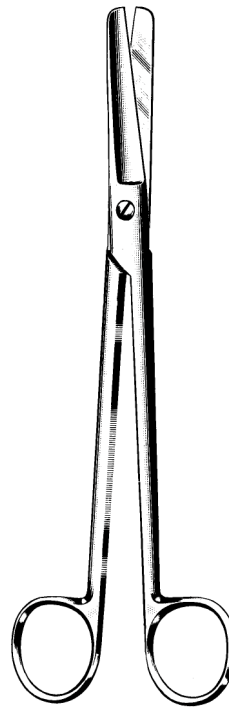

**Straight**  
 OM 67-0164 sharp/sharp  
 OM 67-0166 sharp/blunt  
 OM 67-0168 blunt/blunt

**Curved**  
 OM 67-0170 sharp/sharp  
 OM 67-0172 sharp/blunt  
 OM 67-0174 blunt/blunt

**SIMS SCISSORS**  
 8" (203mm)

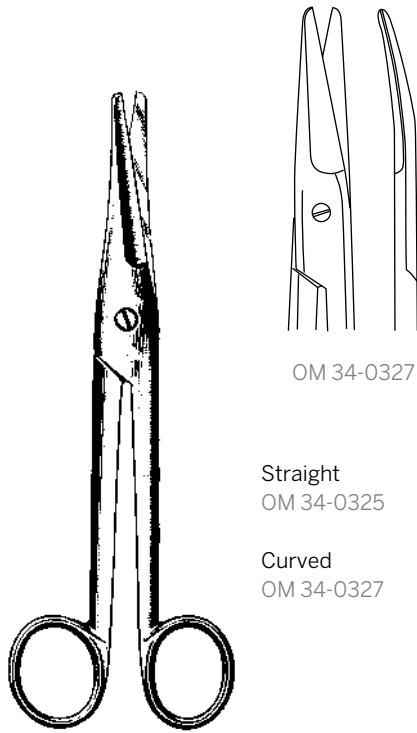

OM 34-0327

Straight  
OM 34-0325

Curved  
OM 34-0327

**MAYO-NOBLE SCISSORS**

6 1/2" (165mm) Beveled blades

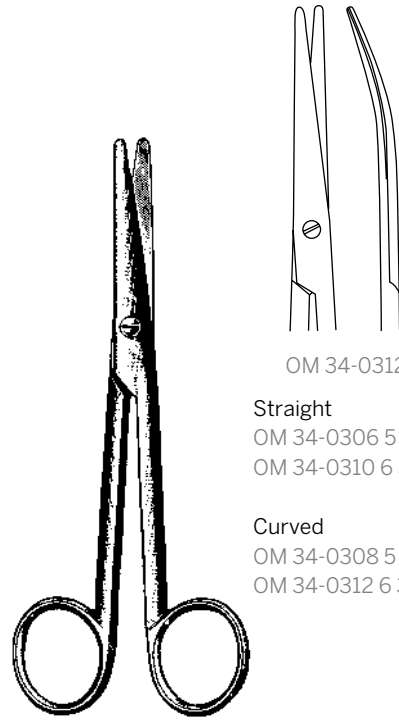

OM 34-0312

Straight  
OM 34-0306 5 1/2" (140mm)  
OM 34-0310 6 3/4" (171mm)

Curved  
OM 34-0308 5 1/2" (140mm)  
OM 34-0312 6 3/4" (171mm)

**MAYO-STILLE SCISSORS**

Rounded blades



OM 34-0338

**FERGUSON SCISSORS**

7" (178mm)  
Angled on flat

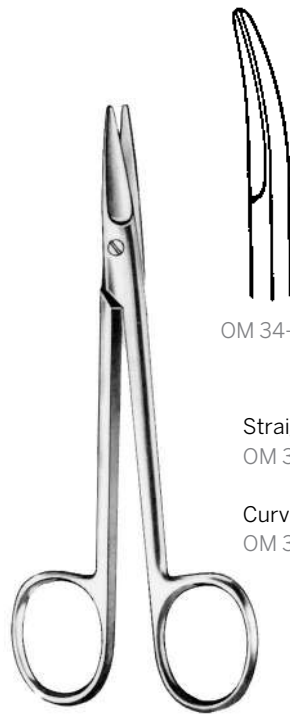

OM 34-0354

Straight  
OM 34-0348

Curved  
OM 34-0354

**SISTRUNK SCISSORS**

5" (127mm) Delicate

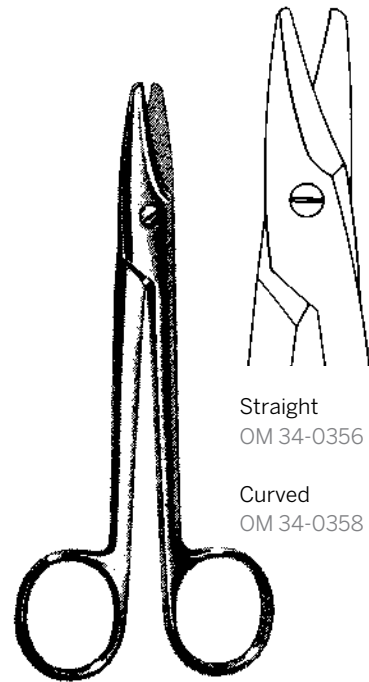

Straight  
OM 34-0356

Curved  
OM 34-0358

**SISTRUNK SCISSORS**

5 1/2" (140mm) Heavy pattern



OM 34-0462

**Straight**

- OM 34-0436 4 1/2" (114mm)
- OM 34-0458 6" (152mm)
- OM 34-0466 7" (178mm)
- OM 34-0472 8" (203mm)
- OM 34-0476 9" (229mm)
- OM 34-0486 11" (279mm)

**Curved**

- OM 34-0438 4 1/2" (114mm)
- OM 34-0492 5 3/4" (146mm) delicate
- OM 34-0462 6" (152mm)
- OM 34-0470 7" (178mm)
- OM 34-0494 7" (178mm) delicate
- OM 34-0474 8" (203mm)
- OM 34-0478 9" (229mm)
- OM 34-0488 11" (279mm)

**METZENBAUM SCISSORS**

blunt points

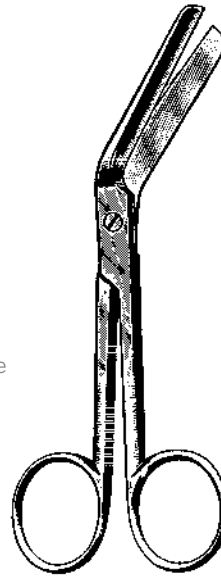

**Angled sideways**

- OM 34-0502 5 1/2" (140mm)
- OM 34-0504 8 1/2" (216mm)

**BRAUN EPISIOTOMY SCISSORS**

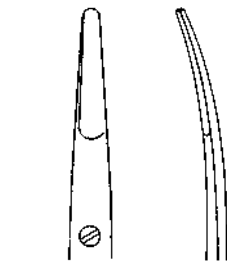
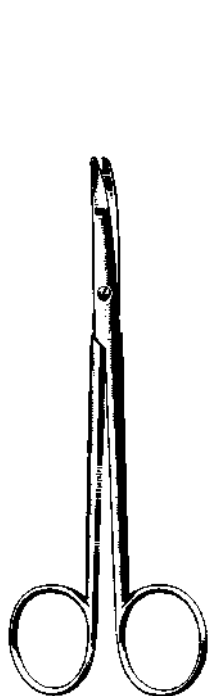

OM 34-0560 OM 34-0562

**Curved**

- OM 34-0560
- 5" (127mm)
- flat blunt tips

- OM 34-0562
- 7" (178mm)
- flat blunt tips

**RAGNELL SCISSORS**

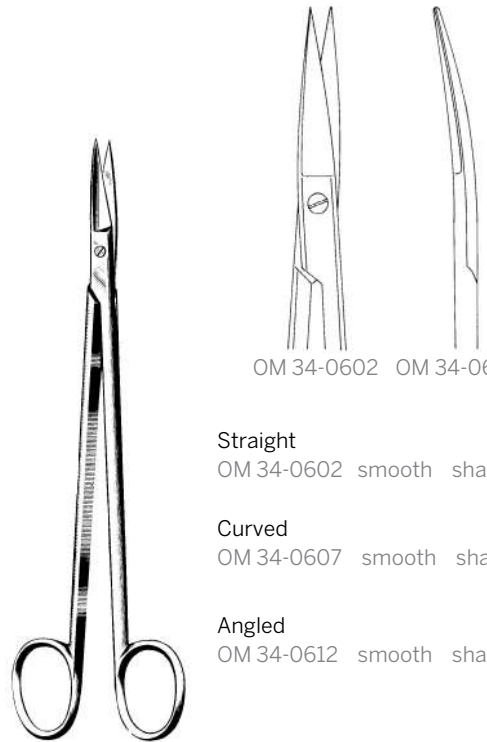

OM 34-0602 OM 34-0607

**Straight**

- OM 34-0602 smooth sharp/sharp

**Curved**

- OM 34-0607 smooth sharp/sharp

**Angled**

- OM 34-0612 smooth sharp/sharp

**KELLY FISTULA SCISSORS**

6 1/4" (159mm)



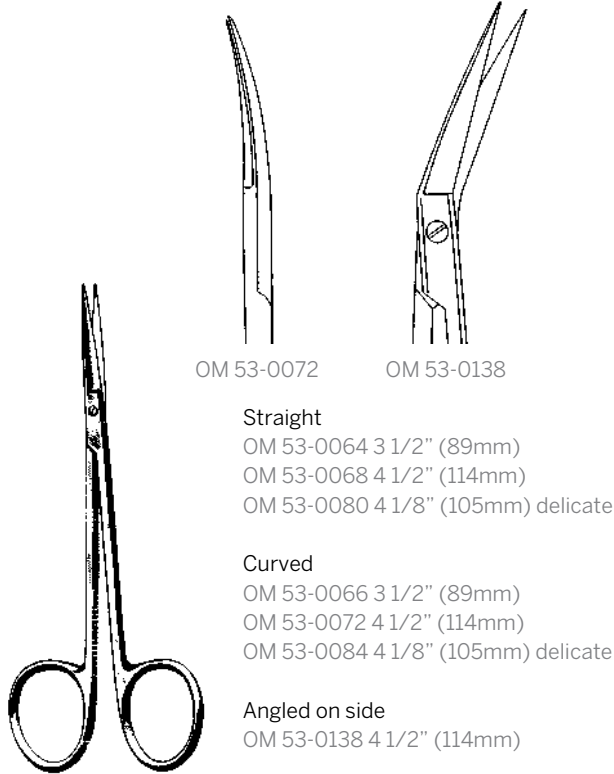

OM 53-0072

OM 53-0138

**Straight**

OM 53-0064 3 1/2" (89mm)  
 OM 53-0068 4 1/2" (114mm)  
 OM 53-0080 4 1/8" (105mm) delicate

**Curved**

OM 53-0066 3 1/2" (89mm)  
 OM 53-0072 4 1/2" (114mm)  
 OM 53-0084 4 1/8" (105mm) delicate

**Angled on side**

OM 53-0138 4 1/2" (114mm)

**IRIS SCISSORS**

Sharp points

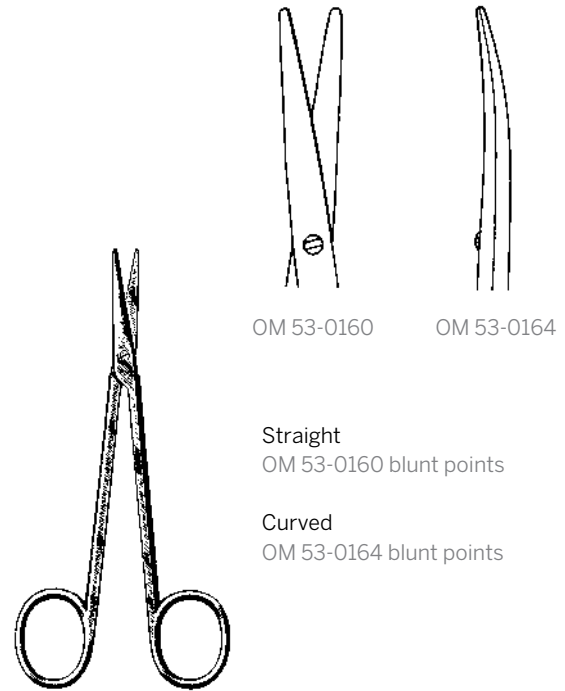

OM 53-0160

OM 53-0164

**Straight**

OM 53-0160 blunt points

**Curved**

OM 53-0164 blunt points

**STRABISMUS SCISSORS**

4" (102mm)

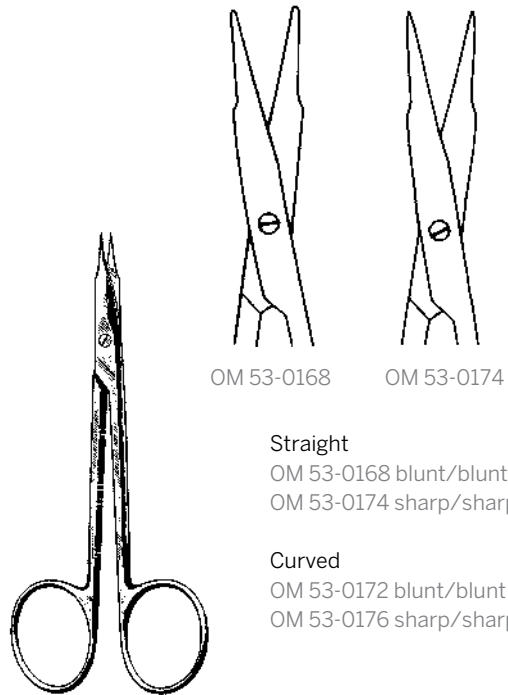

OM 53-0168

OM 53-0174

**Straight**

OM 53-0168 blunt/blunt  
 OM 53-0174 sharp/sharp

**Curved**

OM 53-0172 blunt/blunt  
 OM 53-0176 sharp/sharp

**STEVENS TENOTOMY SCISSORS**

4 1/4" (108mm)



**Straight**

OM 53-0265 3 3/4" (95mm)

**Curved**

OM 53-0267 4" (102mm)

**IRIS SCISSORS RIBBON TYPE**

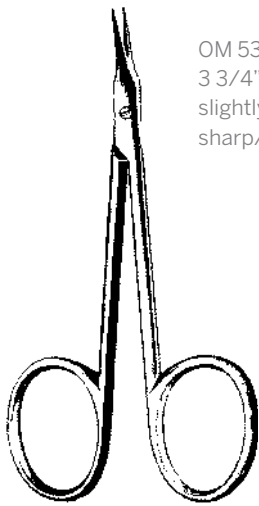

OM 53-0316  
3 3/4" (95mm)  
slightly curved  
sharp/sharp

**GRADLE SCISSORS**



OM 53-0318  
4" (102mm)  
slightly curved  
ribbon type  
sharp/sharp

**GRADLE SCISSORS**

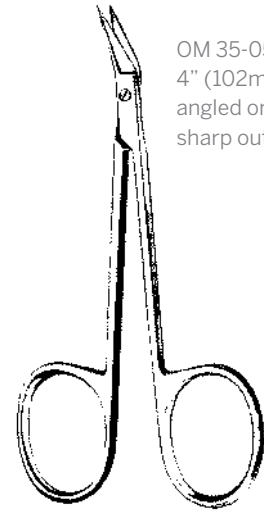

OM 35-0515  
4" (102mm)  
angled on flat  
sharp outside edges

**BIRO DERMAL  
NAEVUS SCISSORS**



OM 35-0078  
4 5/8" (117.5mm)  
with suture hole

OM 35-0078SC  
4 5/8" (117.5mm)  
with suture hole  
super cut

**LITTLER SCISSORS**

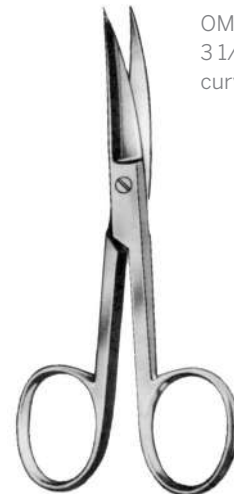

OM 69-0106  
3 1/2" (89mm)  
curved stainless

**NAIL SCISSORS**

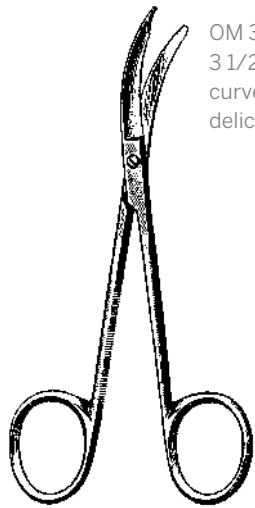

OM 35-0080  
3 1/2" (89mm)  
curved on side  
delicate

**SHORTBENT STITCH  
SCISSORS**



Straight  
OM 35-0068  
3 1/2" (89mm)  
delicate

OM 35-0092  
4 3/4" (121mm)  
delicate

**SPENCER STITCH  
SCISSORS**

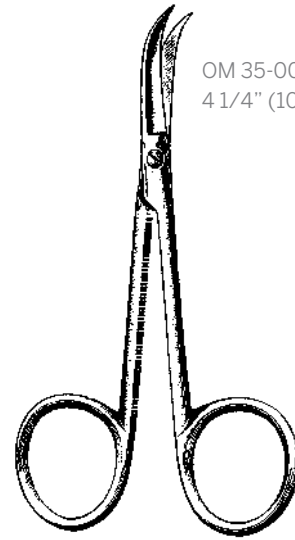

OM 35-0084  
4 1/4" (108mm)

**HILL STITCH  
SCISSORS**

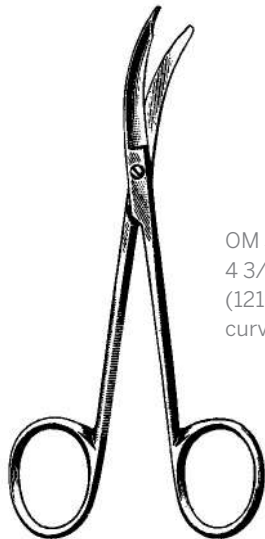

OM 35-0104  
4 3/4"  
(121mm)  
curved on side

**NORTHBENT STITCH SCISSORS**

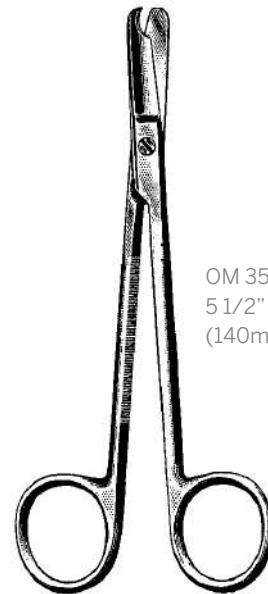

OM 35-0120  
5 1/2"  
(140mm)

**LITTAUER STITCH SCISSORS**

**Note:** Tungsten carbide (TC) is one of the hardest alloys made today. Our TC scissors have tungsten carbide firmly bonded to both cutting edges. We guarantee that they will stay sharp for at least three years. The finger rings are gold plated for easy identification.

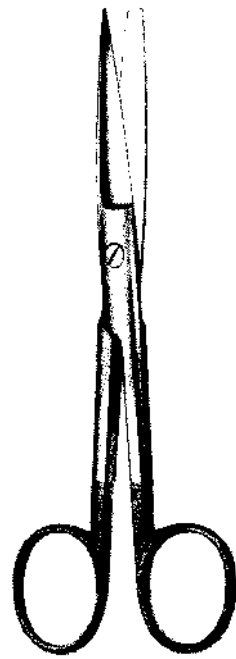

**TC OPERATING SCISSORS**

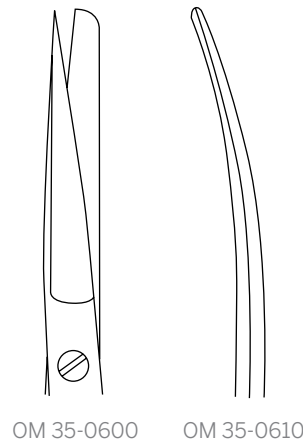

**Straight**  
OM 35-0600  
5 1/2" (140mm)  
sharp/blunt

**Curved**  
OM 35-0610  
5 1/2" (140mm)  
sharp/blunt



**TC MAYO SCISSORS**  
Beveled blades

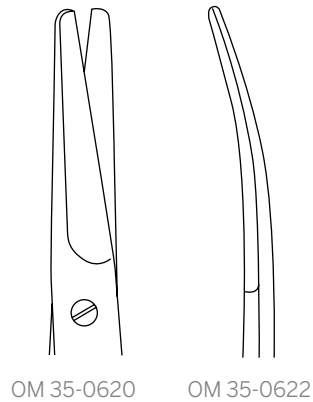

**Straight**  
OM 35-0620 5 1/2" (140mm)  
OM 35-0624 6 3/4" (171mm)  
OM 35-0628 9" (229mm)

**Curved**  
OM 35-0622 5 1/2" (140mm)  
OM 35-0626 6 3/4" (171mm)  
OM 35-0630 9" (229mm)



**TC METZENBAUM SCISSORS**  
Blunt points



**Straight**  
OM 35-0640 6" (152mm)  
OM 35-0644 7" (178mm)  
OM 35-0652 9" (229mm)

**Curved**  
OM 35-0642 6" (152mm)  
OM 35-0646 7" (178mm)  
OM 35-0654 9" (229mm)

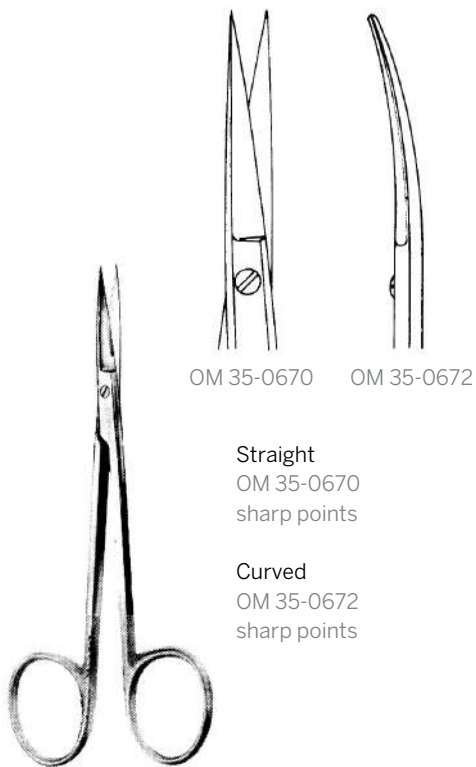

OM 35-0670 OM 35-0672

Straight  
OM 35-0670  
sharp points

Curved  
OM 35-0672  
sharp points

**TC IRIS SCISSORS**  
4 1/2" (114mm)

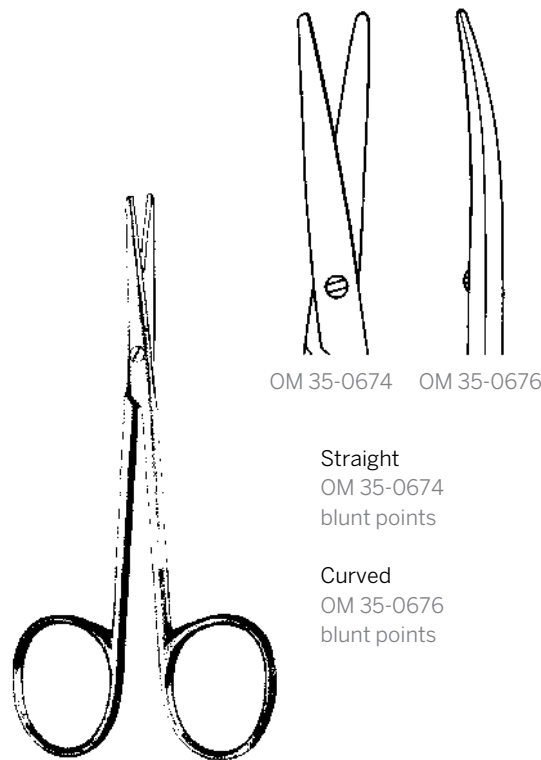

OM 35-0674 OM 35-0676

Straight  
OM 35-0674  
blunt points

Curved  
OM 35-0676  
blunt points

**TC STRABISMUS SCISSORS**  
4 1/2" (114mm)

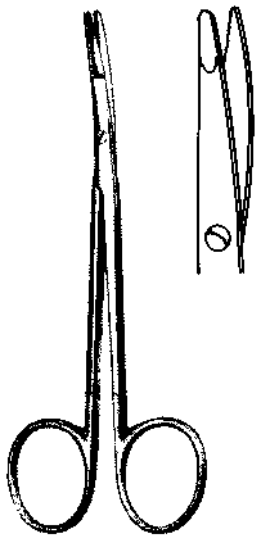

Curved  
OM 35-0510  
4 1/2" (114mm)  
flat tips,  
one serrated and  
one carbide blade

**BLEPHAROPLASTY SCISSORS**

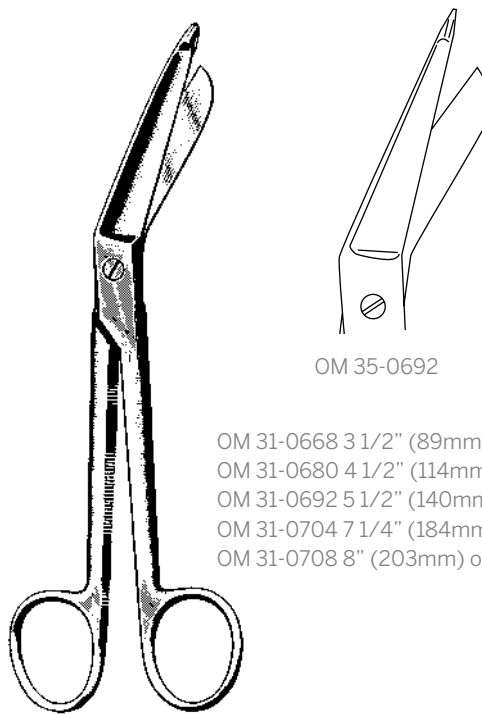

OM 35-0692

OM 31-0668 3 1/2" (89mm)  
OM 31-0680 4 1/2" (114mm)  
OM 31-0692 5 1/2" (140mm)  
OM 31-0704 7 1/4" (184mm)  
OM 31-0708 8" (203mm) one large finger ring

**LISTER BANDAGE SCISSORS**

The delicate offset shanks provide better leverage. The fine knob slides easily under finger and toe bandages.

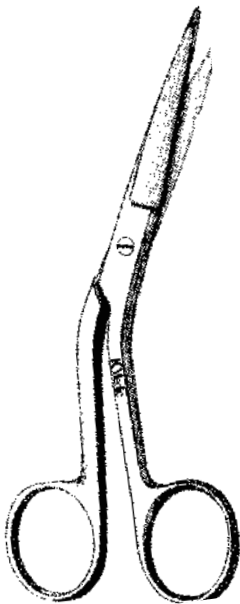

OM 31-0792  
5 1/2" (140mm)  
shanks angled on side  
one serrated blade

**HI-LEVEL BANDAGE SCISSORS**

For finger and toe bandages.



Straight  
OM 31-0804  
5 1/2" (140mm)  
one serrated blade

**KNOWLES BANDAGE SCISSORS**

Useful for cutting tape and bandages.



OM 46-0060  
8" (203mm)

**ESMARCH SHEARS**

For heavier plaster.

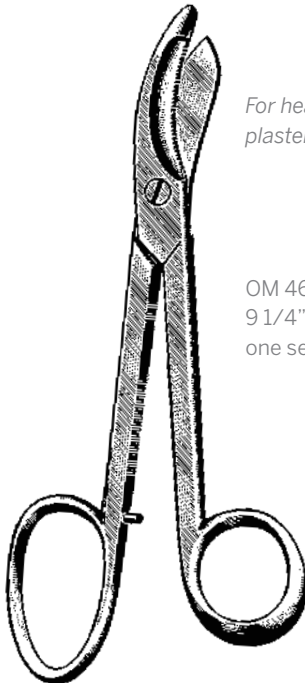

OM 46-0090  
9 1/4" (235mm)  
one serrated blade

**BRUNS SHEARS**

UTILITY SCISSORS

*For light plaster and cloth.*

*With autoclavable plastic finger rings.*

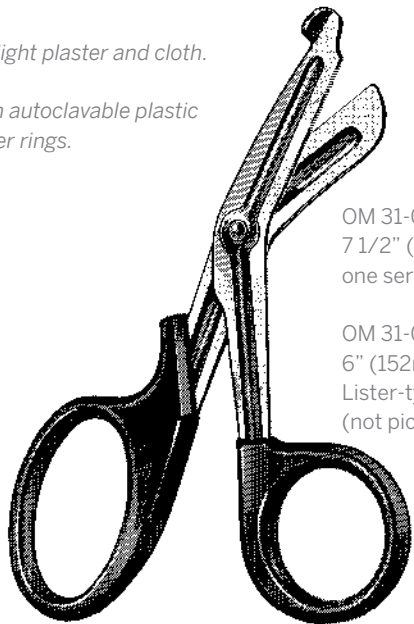

OM 31-0830  
7 1/2" (191mm)  
one serrated blade

OM 31-0832  
6" (152mm)  
Lister-type  
(not pictured)

**UTILITY SCISSORS**

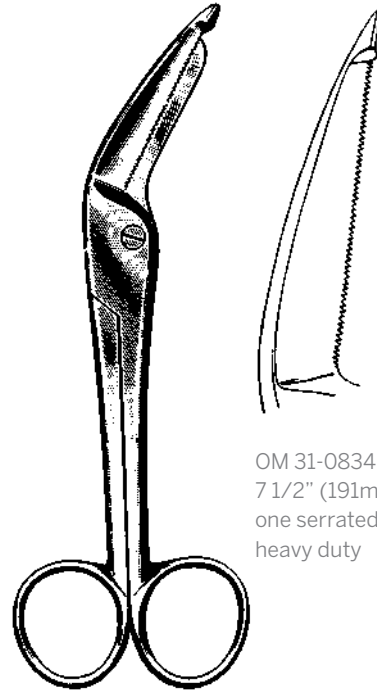

OM 31-0834  
7 1/2" (191mm)  
one serrated blade  
heavy duty

**HERCULES SCISSORS**



*Effective for cloth or cotton wadding.*

OM 31-0836  
8" (203mm)  
with wire cutting notch  
one serrated blade

**ORTHOMED UTILITY SHEARS**



OM MX 5-700  
Pink handle

OM MX 5-702  
Blue handle

**NURSES SCISSORS**  
5 1/2" (140mm)

Notch for cutting cerclage wire up to 1mm.

OM 35-0198

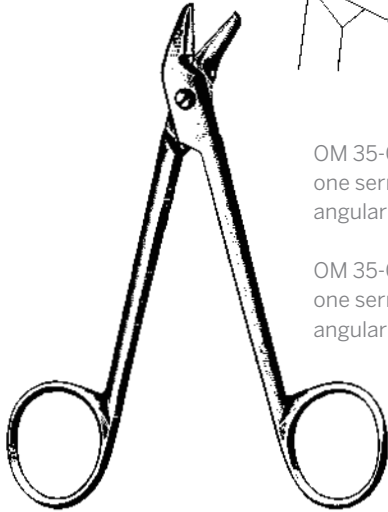
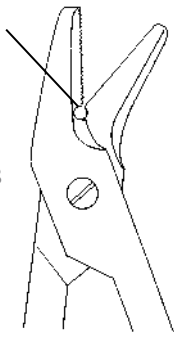

OM 35-0198  
one serrated blade  
angular

OM 35-0200  
one serrated blade  
angular carbide

**WIRE CUTTING SCISSORS**

4 3/4" (121mm)



OM 35-0194

Straight  
OM 35-0168  
smooth

OM 35-0170  
one serrated blade

Curved  
OM 35-0192  
smooth

OM 35-0194  
one serrated blade

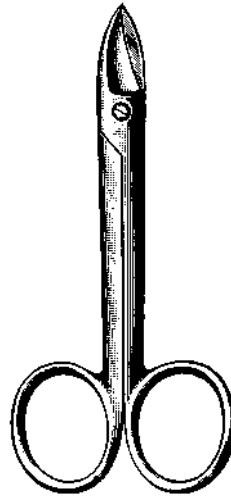

**WIRE CUTTING SCISSORS**

4" (102mm)



OM 36-0063



OM 36-0067

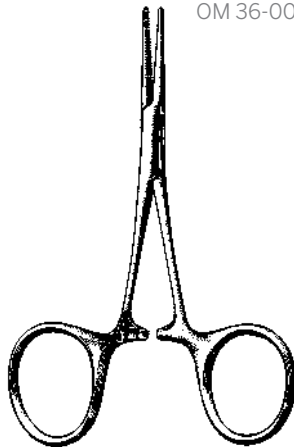

Straight  
OM 36-0063

Curved  
OM 36-0067

**HARTMANN MOSQUITO FORCEPS**

3 1/2" (89mm)



OM 36-0164



OM 36-0165



Straight  
OM 36-0164

Curved  
OM 36-0165

**MICRO MOSQUITO FORCEPS**

5" (127mm) Extremely fine tips



# HEMOSTATIC FORCEPS

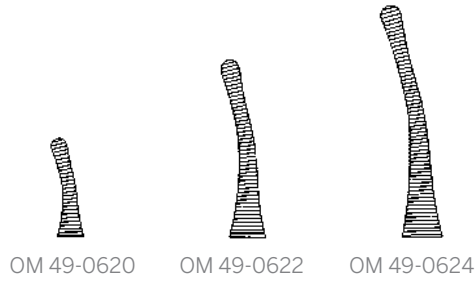

OM 49-0620    OM 49-0622    OM 49-0624



- Straight**
- OM 49-0602    1 1/2" (38mm)
  - OM 49-0604    2" (51mm)
  - OM 49-0606    2 1/2" (64mm)
  - OM 49-0608    3" (76mm)
  - OM 49-0610    3 1/2" (89mm)
- Curved**
- OM 49-0618    1 1/2" (38mm)
  - OM 49-0620    2" (51mm)
  - OM 49-0622    2 1/2" (64mm)
  - OM 49-0624    3" (76mm)
  - OM 49-0626    3 1/2" (89mm)

## JOHNS HOPKINS BULLDOG CLAMPS

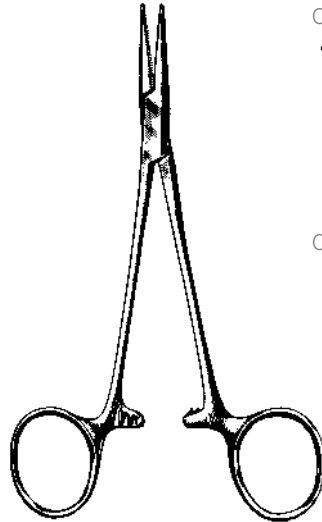

## HALSTED MOSQUITO FORCEPS

5" (127mm)

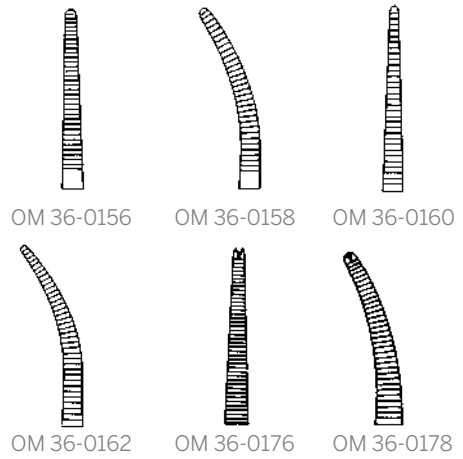

OM 36-0156    OM 36-0158    OM 36-0160  
OM 36-0162    OM 36-0176    OM 36-0178

- Straight**
- OM 36-0156
  - OM 36-0160 delicate
  - OM 36-0076 1x2 teeth
- Curved**
- OM 36-0158
  - OM 36-0162 delicate
  - OM 36-0078 1x2 teeth

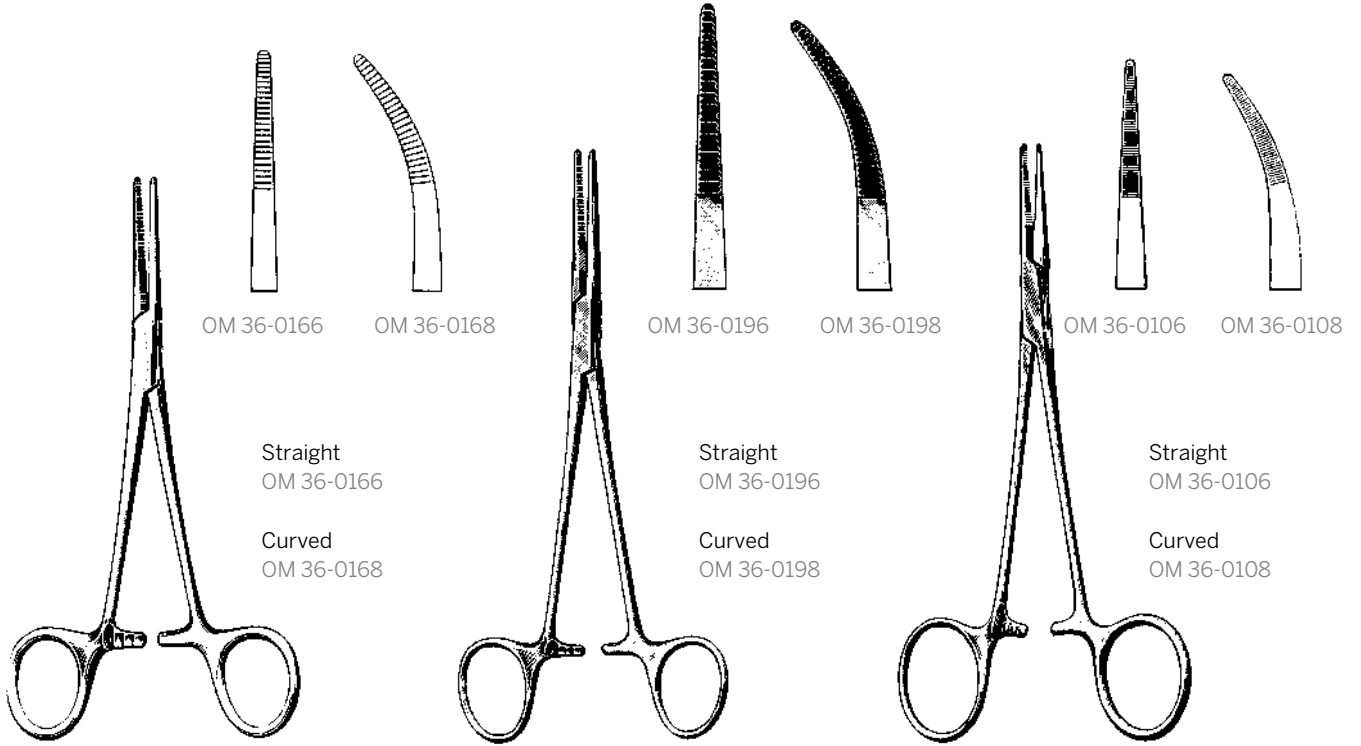

OM 36-0166    OM 36-0168

- Straight**  
OM 36-0166
- Curved**  
OM 36-0168

OM 36-0196    OM 36-0198

- Straight**  
OM 36-0196
- Curved**  
OM 36-0198

OM 36-0106    OM 36-0108

- Straight**  
OM 36-0106
- Curved**  
OM 36-0108

## KELLY FORCEPS

5 1/2" (140mm)



## RANKIN-KELLY FORCEPS

6 1/4" (159mm)

## PROVIDENCE HOSPITAL FORCEPS

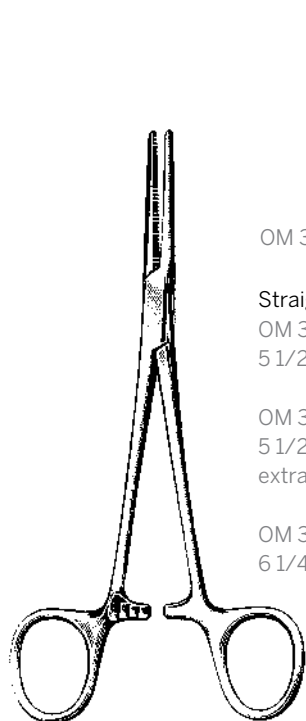

5 1/2" (140mm)



- |   |   |
|---|---|
|  |  |
| OM 36-0176  | OM 36-0178  |
| <b>Straight</b>   | <b>Curved</b>   |
| OM 36-0176  | OM 36-0178  |
| 5 1/2" (140mm)  | 5 1/2" (140mm)  |
| OM 36-0180  | OM 36-0182  |
| 5 1/2" (140mm)  | 5 1/2" (140mm)  |
| extra delicate  | extra delicate  |
| OM 36-0186  | OM 36-0188  |
| 6 1/4" (159mm)  | 6 1/4" (159mm)  |

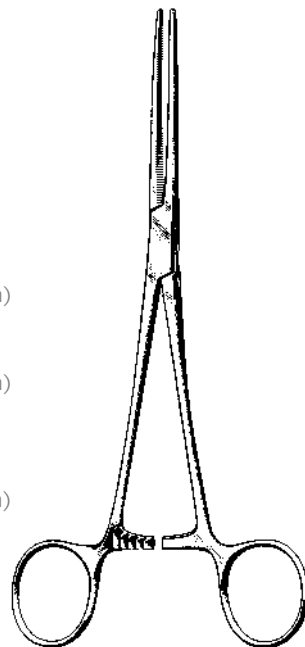

**CRILE FORCEPS**

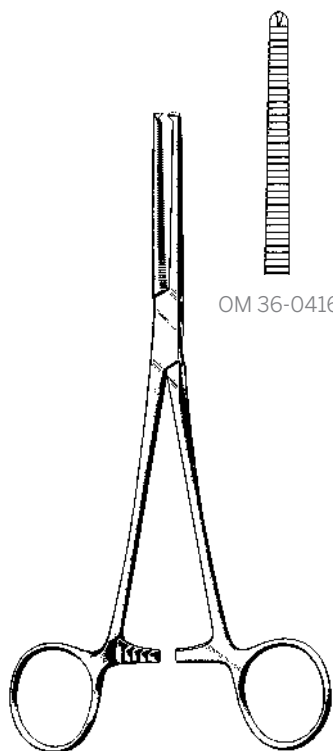

- |   |   |
|---|---|
|  |  |
| OM 36-0306  | OM 36-0308  |
| <b>Straight</b>   |   |
| OM 36-0306  | 5 1/2" (140mm)  |
| OM 36-0316  | 6 1/4" (159mm)  |
| OM 36-0326  | 7 1/4" (184mm)  |
| OM 36-0336  | 8" (203mm)  |
| OM 36-0346  | 9" (229mm)  |
| OM 36-0356  | 10" (254mm)   |
| OM 36-0360  | 12" (305mm)   |
| <b>Curved</b>   |   |
| OM 36-0308  | 1/2" (140mm)  |
| OM 36-0318  | 6 1/4" (159mm)  |
| OM 36-0328  | 7 1/4" (184mm)  |
| OM 36-0338  | 8" (203mm)  |
| OM 36-0348  | 9" (229mm)  |
| OM 36-0358  | 10" (254mm)   |
| OM 36-0362  | 12" (305mm)   |

**ROCHESTER PEAN FORCEPS**



- |   |   |
|---|---|
|  |  |
| OM 36-0416  | OM 36-0418  |
| <b>Straight</b>   | <b>Curved</b>   |
| OM 36-0406  | OM 36-0408  |
| 5 1/2" (140mm)  | 5 1/2" (140mm)  |
| OM 36-0416  | OM 36-0418  |
| 6 1/4" (159mm)  | 6 1/4" (159mm)  |
| OM 36-0426  | OM 36-0428  |
| 7 1/4" (184mm)  | 7 1/4" (184mm)  |
| OM 36-0436  | OM 36-0438  |
| 8" (203mm)  | 8" (203mm)  |
| OM 36-0446  | OM 36-0448  |
| 9" (229mm)  | 9" (229mm)  |
| OM 36-0456  | OM 36-0458  |
| 10" (254mm)   | 10" (254mm)   |

**ROCHESTER-OSHSNER FORCEPS**  
1 x 2 Teeth

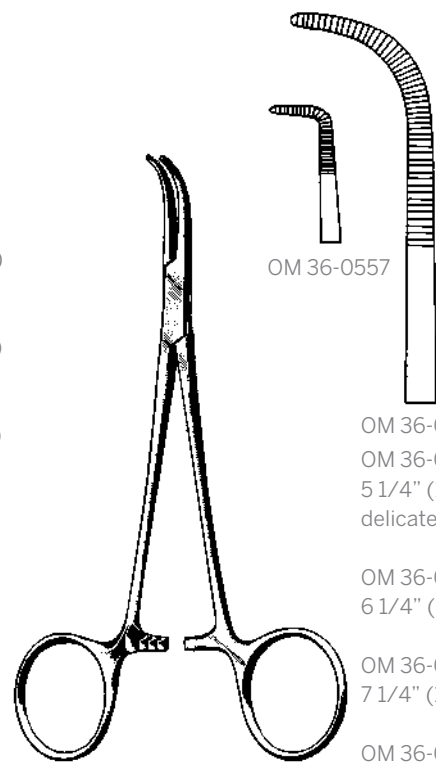

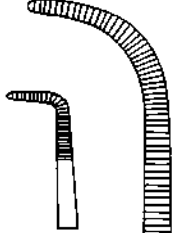
- |   |
|---|
|  |
| OM 36-0557  |
| OM 36-0566  |
| OM 36-0557  |
| 5 1/4" (133mm)  |
| delicate  |
| OM 36-0562  |
| 6 1/4" (159mm)  |
| OM 36-0564  |
| 7 1/4" (184mm)  |
| OM 36-0566  |
| 9" (229mm)  |

**MIXTER FORCEPS**  
Fully curved



OM 36-0570  
7" (171mm)  
serrated

**GEMINI MIXTER FORCEPS**

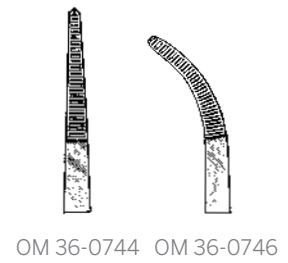

Straight  
OM 36-0744

Curved  
OM 36-0746

**ADSON HEMOSTATIC FORCEPS**  
7 1/4" (184mm)

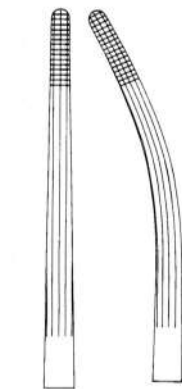
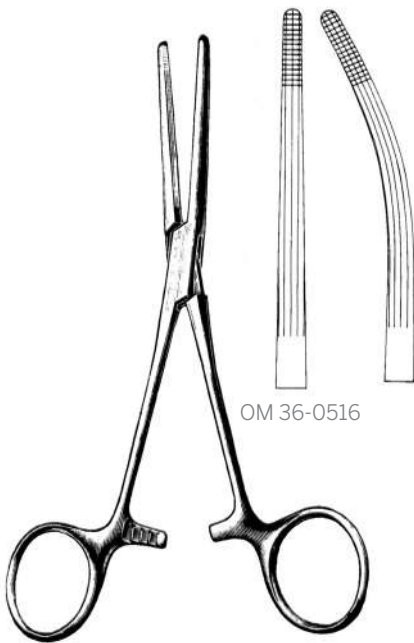

OM 36-0518  
  
Straight  
OM 36-0516  
6 1/4" (159mm)

OM 36-0536  
8" (203mm)  
  
Curved  
OM 36-0518  
6 1/4" (159mm)

OM 36-0538  
8" (203mm)

**ROCHESTER-CARMALT FORCEPS**

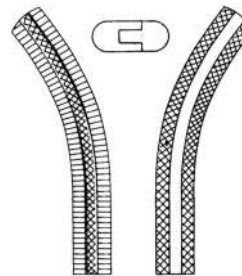

OM 36-0818  
  
Straight  
OM 36-0816  
6 1/2" (165mm)

OM 36-0826  
7 1/2" (191mm)  
  
Curved  
OM 36-0818  
6 1/2" (165mm)

OM 36-0828  
7 1/2" (191mm)

**FERGUSON ANGIOTRIBE FORCEPS**

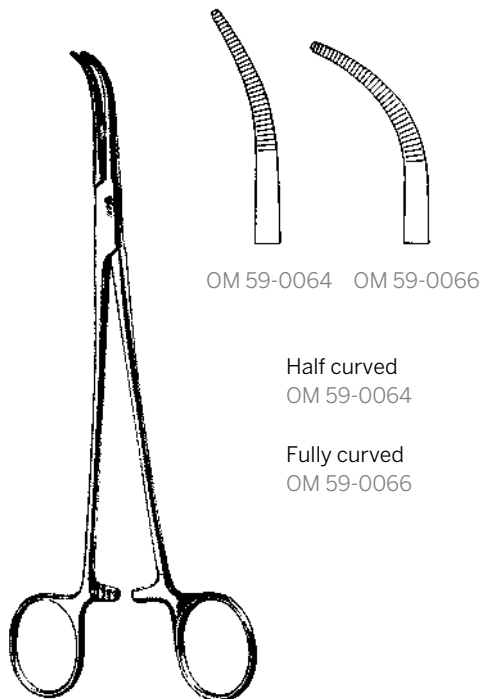

OM 59-0064 OM 59-0066

Half curved  
OM 59-0064

Fully curved  
OM 59-0066

**SCHNIDT FORCEPS**

7 1/2" (191mm)

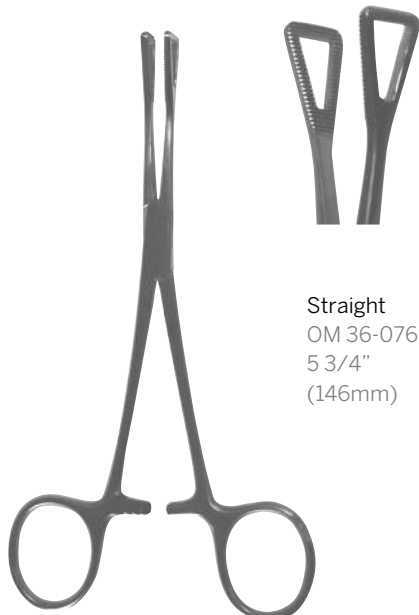

Straight  
OM 36-0766  
5 3/4"  
(146mm)

**PENNINGTON FORCEPS**

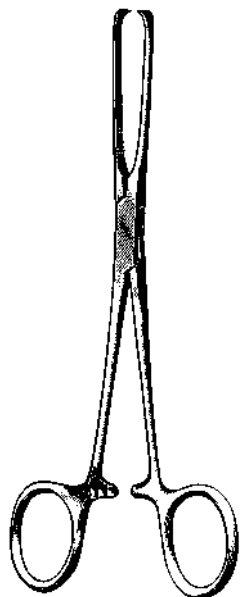

  
OM 43-0105

OM 43-0105 4 3/4" (121mm)  
4x5 teeth delicate

OM 43-0107 5 3/4" (146mm)  
4x5 teeth delicate

OM 43-0110 6" (152mm)  
3x4 teeth standard

OM 43-0112 6" (152mm)  
4x5 teeth standard

OM 43-0116 6" (152mm)  
5x6 teeth standard

OM 49-0628 10"  
5x6 teeth standard

OM 49-0629 12"  
5x6 teeth standard

**ALLIS TISSUE FORCEPS**



OM 43-0124  
7 1/2" (191mm)  
5x6 teeth

**ALLIS TISSUE FORCEPS**

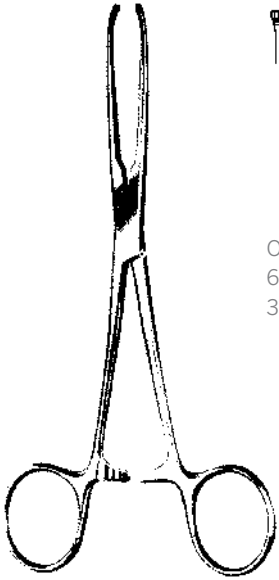

OM 43-0168  
6" (152mm)  
3x4 teeth

**ALLIS-JUDD TISSUE FORCEPS**

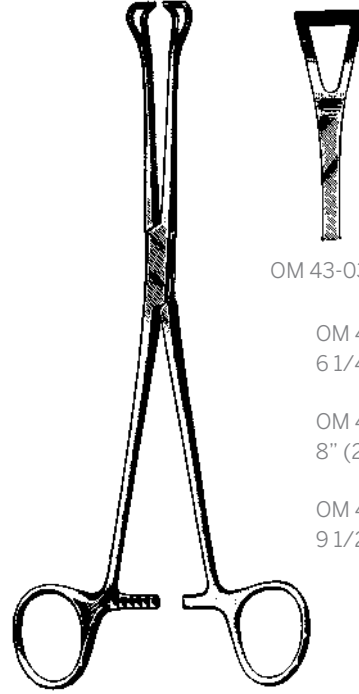

OM 43-0310

OM 43-0310  
6 1/4" (159mm)

OM 43-0324  
8" (203mm)

OM 43-0326  
9 1/2" (241mm)

**BABCOCK FORCEPS**



OM 36-0696  
6 1/4" (159mm)  
3x3 prongs

**LAHEY VULSELLUM FORCEPS**

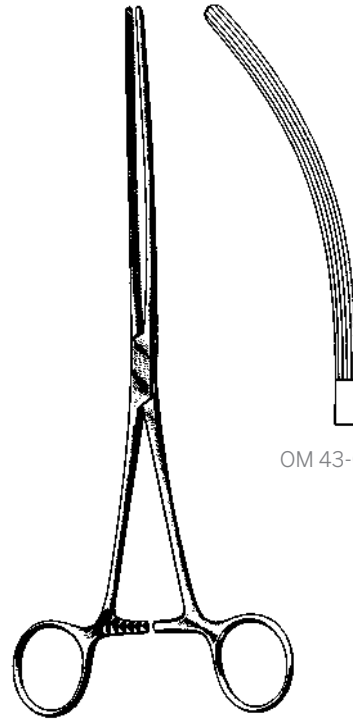

OM 43-0524

Straight  
OM 43-0520

Curved  
OM 43-0524

**DOYEN CLAMP**  
9" (229mm) Longitudinal serrations

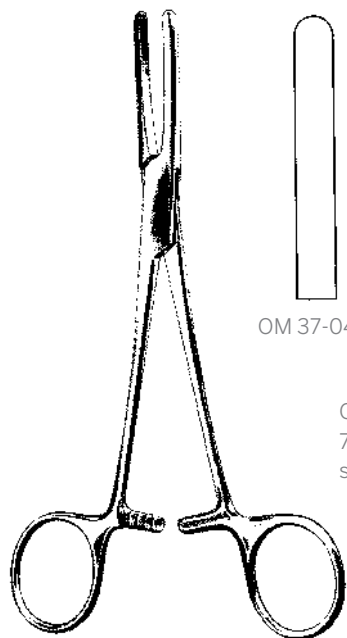

OM 37-0444

OM 37-0444  
7" (178mm)  
smooth

**PRESBYTERIAN TUBE  
OCCLUDING FORCEPS**

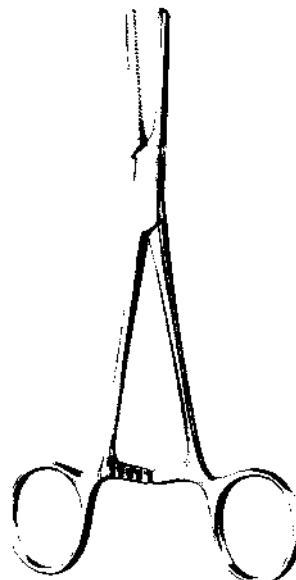

OM 37-0448

OM 37-0448  
5 1/2" (140mm)

OM 37-0450  
7 1/4" (184mm)

OM 37-0452  
8" (203mm)

**VORSE TUBE OCCLUDING FORCEPS**  
Serrated

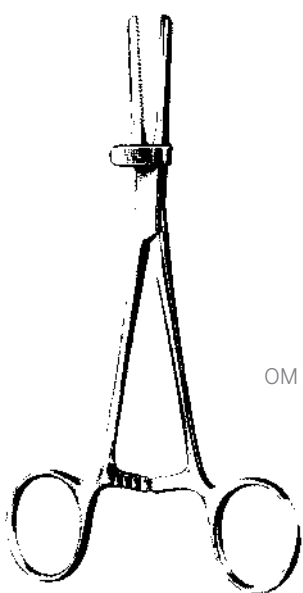

OM 37-0453

OM 37-0453 5 1/2" (140mm)  
OM 37-0454 7 1/4" (184mm)  
OM 37-0455 8" (203mm)

**VORSE TUBE OCCLUDING FORCEPS**  
Serrated, with guard

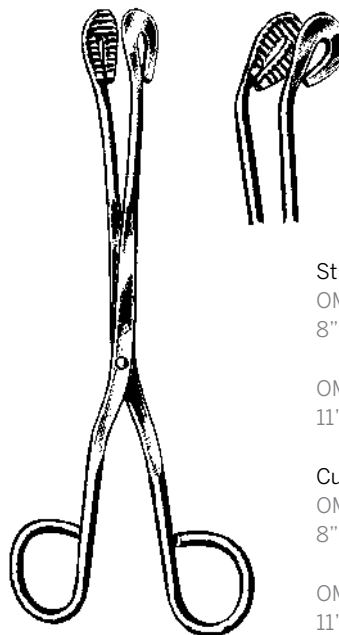

Straight  
OM 39-0644  
8" (203mm)

OM 39-0646  
11" (279mm)

Curved  
OM 39-0648  
8" (203mm)

OM 39-0650  
11" (279mm)

**UTILITY AND  
STERILIZER FORCEPS**

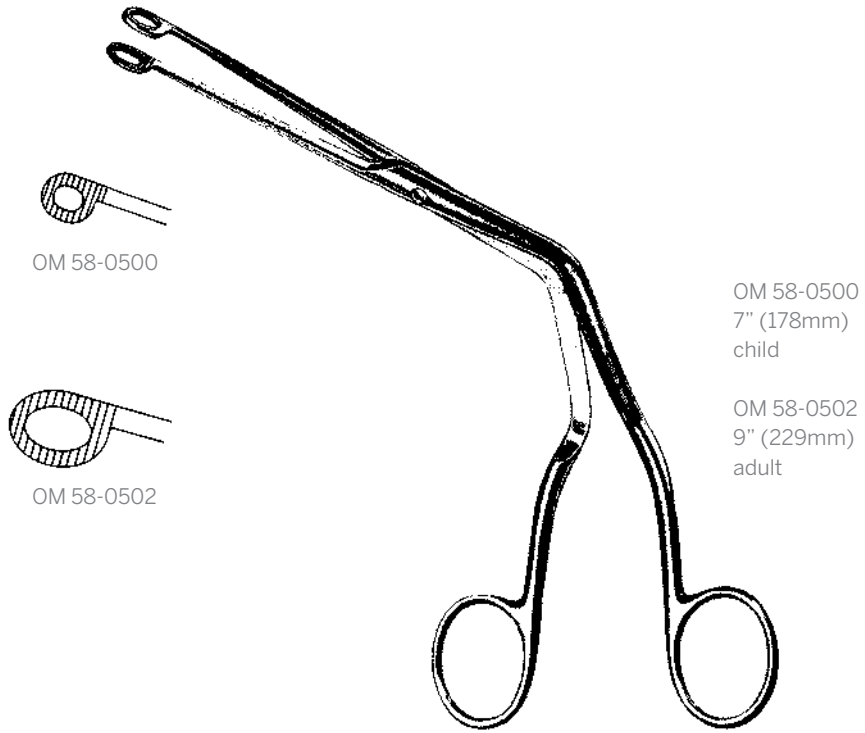

**MAGILL ENDOTRACHEAL CATHETER INTRODUCING FORCEPS**



OM 37-0470  
2 1/2" (64mm)

OM 37-0478  
3 1/4" (83mm)

**JONES TOWEL FORCEPS**



OM 37-0458  
3 1/2" (89mm)

OM 37-0462  
5 1/4" (133mm)

**BACKHAUS TOWEL FORCEPS**

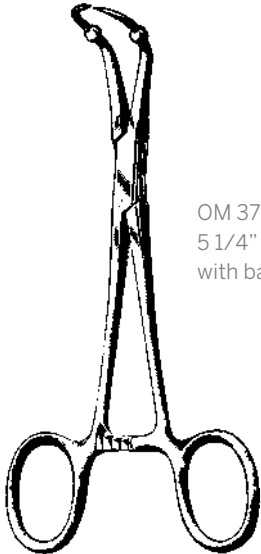

OM 37-0464  
5 1/4" (133mm)  
with ball stops

**BACKHAUS-ROEDER TOWEL CLAMP**

TOWEL AND SPONGE FORCEPS/DRESSING AND TISSUE FORCEPS



OM 47-0466

OM 37-0466  
4" (102mm)  
non-perforating

OM 37-0468  
5 1/4" (133mm)  
non-perforating

**LORNA (EDNA)  
TOWEL CLAMP**

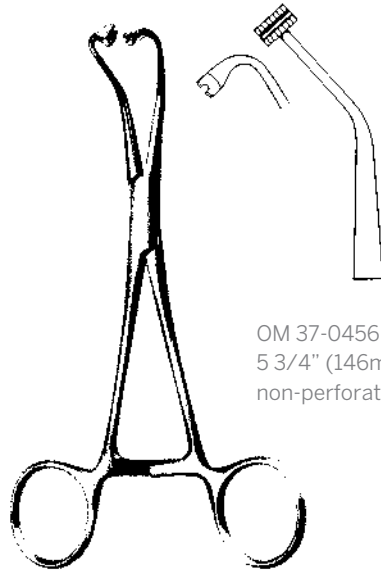

OM 37-0456  
5 3/4" (146mm)  
non-perforating

**PEERS TOWEL CLAMP**

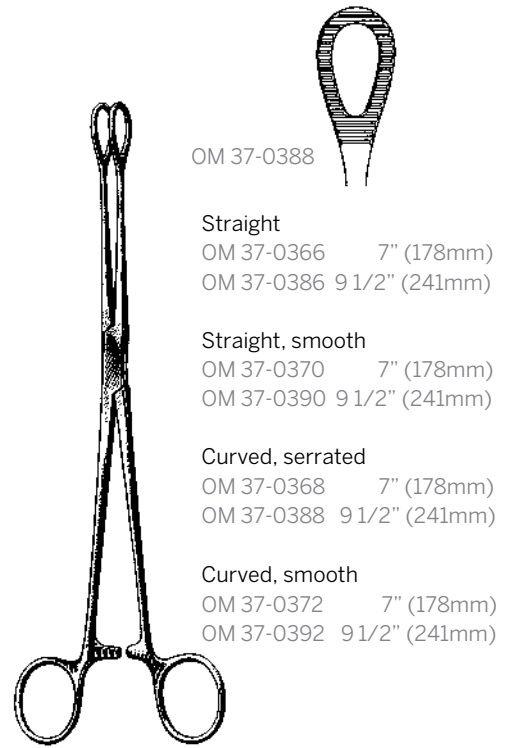

OM 37-0388

**Straight**  
OM 37-0366 7" (178mm)  
OM 37-0386 9 1/2" (241mm)

**Straight, smooth**  
OM 37-0370 7" (178mm)  
OM 37-0390 9 1/2" (241mm)

**Curved, serrated**  
OM 37-0368 7" (178mm)  
OM 37-0388 9 1/2" (241mm)

**Curved, smooth**  
OM 37-0372 7" (178mm)  
OM 37-0392 9 1/2" (241mm)

**FOERSTER SPONGE  
FORCEPS**



OM 47-0466

OM 38-0076 4 1/2" (114mm)  
OM 38-0080 5" (127mm)  
OM 38-0084 5 1/2" (140mm)  
OM 38-0088 6" (152mm)  
OM 38-0094 8" (203mm)  
OM 38-0100 10" (254mm)  
OM 38-0106 12" (305mm)

**DRESSING FORCEPS**  
Serrated



1x2 teeth  
OM 38-0264 4 1/2" (114mm)  
OM 38-0268 5" (127mm)  
OM 38-0272 5 1/2" (140mm)  
OM 38-0276 6" (152mm)  
OM 38-0280 8" (203mm)  
OM 38-0286 10" (254mm)  
OM 38-0290 12" (305mm)

2x3 teeth  
OM 38-0292 5" (127mm)  
OM 38-0296 5 1/2" (140mm)

3x4 teeth  
OM 38-0304 5 1/2" (140mm)

**TISSUE FORCEPS**



OM 38-0322

OM 38-0324

**FERRIS-SMITH TISSUE FORCEPS**  
7" (178mm) with platform



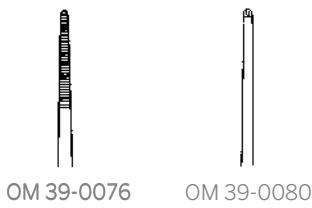

OM 39-0076      OM 39-0080

Serrated  
 OM 39-0076      5" (127mm)  
 OM 39-0086      6" (152mm)

1x2 teeth  
 OM 39-0080      5" (127mm)  
 OM 39-0088      6" (152mm)

**SEMKEN FORCEPS**

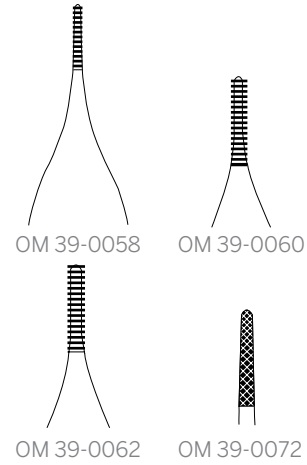

OM 39-0058 micro tip  
 OM 39-0060 delicate tip  
 OM 39-0062 standard tip  
 OM 39-0072 carbide tip

**ADSON DRESSING FORCEPS**

4 3/4" (121mm) serrated

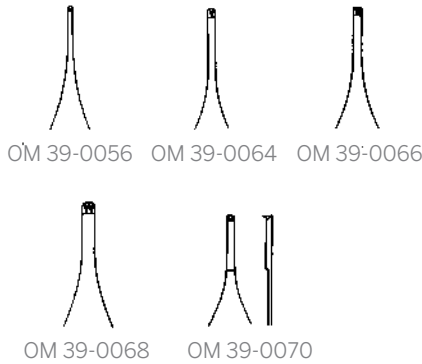
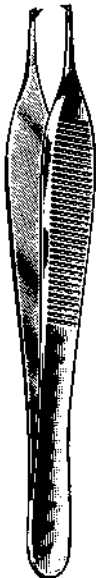

OM 39-0056      OM 39-0064      OM 39-0066

OM 39-0068      OM 39-0070

1x2 teeth  
 OM 39-0056      micro tip  
 OM 39-0063      serrated tip  
 OM 39-0064      delicate tip  
 OM 39-0066      standard tip  
 OM 39-0070      delicate, with tying platform  
 OM 39-0071      carbide tip

2x3 teeth  
 OM 39-0068

**ADSON TISSUE FORCEPS**

4 3/4" (121mm)

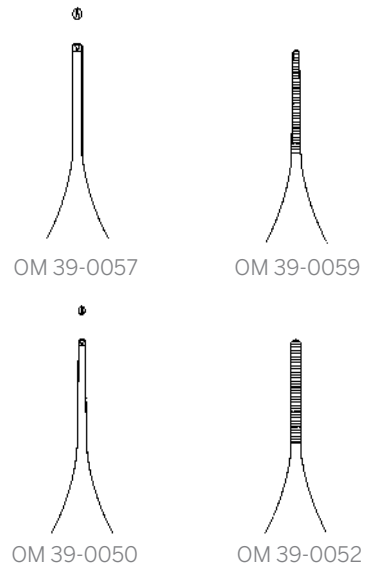

OM 39-0057      micro 1x2 teeth  
 OM 39-0059      micro serrated  
 OM 39-0050      1x2 teeth  
 OM 39-0052      serrated

**ADSON DRESSING AND TISSUE FORCEPS**

6" (152mm)



OM 39-0092  
4 3/4" (121mm)  
9x9 teeth  
side grasping

**ADSON BROWN TISSUE FORCEPS**

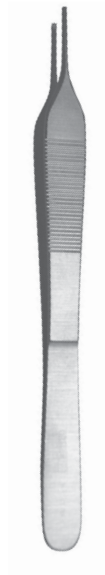

OM 39-0098  
7" (178mm) 3mm  
2x3 teeth

OM 39-0099  
7" (178mm) 3mm  
2x3 teeth  
with carbide inserts

**ADSON TISSUE FORCEPS**



OM 39-0055

**ADSON TISSUE FORCEP**  
TC 1S2 Teeth SERR. 6"



OM 39-0136

OM 39-0128 4 1/2" (114mm)  
OM 39-0132 5" (127mm)  
OM 39-0136 5 1/2" (140mm)  
OM 39-0140 6" (152mm)

**DRESSING FORCEPS**  
Serrated with fluted handles



OM 39-0310 4 1/2" (114mm)  
OM 39-0314 5" (127mm)  
OM 39-0318 5 1/2" (140mm)  
OM 39-0322 6" (152mm)

**TISSUE FORCEPS**  
1x2 teeth with fluted handles

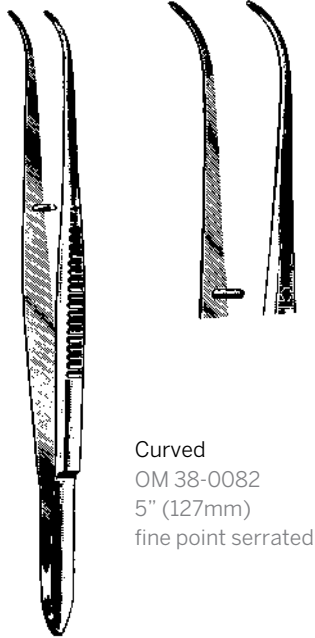

Curved  
OM 38-0082  
5" (127mm)  
fine point serrated

**DRESSING FORCEPS**



OM 39-0192 6" (152mm)  
OM 39-0196 8" (203mm)  
OM 39-0197 9" (229mm)  
OM 39-0198 10" (254mm)

**RUSSIAN  
TISSUE FORCEPS**



OM 39-0192

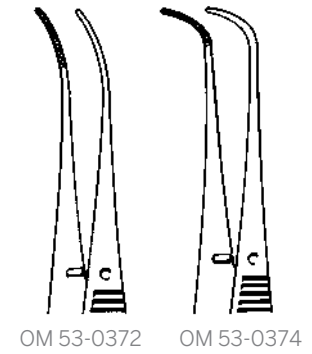

OM 53-0372 OM 53-0374

OM 53-0368 4" (102mm)  
straight

OM 53-0372 4" (102mm)  
half curved

OM 53-0374 4" (102mm)  
fully curved

**EYE DRESSING FORCEPS**  
4" (102mm) serrated



OM 49-0168 OM 49-0170 OM 49-0172

OM 49-0168 6 1/4" (159mm) 1.5mm  
OM 49-0170 8" (203mm) 1.5mm  
OM 49-0172 9 1/4" (235mm) 1.5mm  
OM 49-0180 6 1/4" (159mm) 2.0mm  
OM 49-0182 8" (203mm) 2.0mm  
OM 49-0184 9 1/4" (235mm) 2.0mm  
OM 49-0210 6 1/4" (159mm) 3.5mm  
OM 49-0212 8" (203mm) 3.5mm  
OM 49-0216 9 1/4" (235mm) 3.5mm

**DEBAKEY ATRAUMATIC  
TISSUE FORCEPS**



OM 53-0404



OM 53-0408



OM 53-0420



OM 53-0422

OM 53-0404 straight serrated  
OM 53-0408 curved serrated  
OM 53-0420 straight 1x2 teeth  
OM 53-0422 curved 1x2 teeth

**GRAEFE EYE DRESSING FORCEPS**  
2 1/2" (64mm)

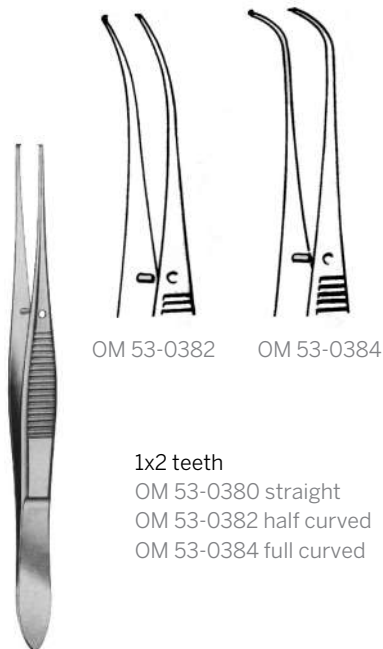

OM 53-0382 OM 53-0384

1x2 teeth  
 OM 53-0380 straight  
 OM 53-0382 half curved  
 OM 53-0384 full curved

**IRIS FORCEPS**

4" (102mm)



Extra narrow  
 OM 38-0166

**DRESSING FORCEPS**

5 1/2" (140mm)



1x2 teeth delicate  
 OM 38-0180 straight  
 OM 38-0181 curved  
 OM 38-0182 straight TC

**GERALD DRESSING FORCEPS**

6 3/4" (171mm)

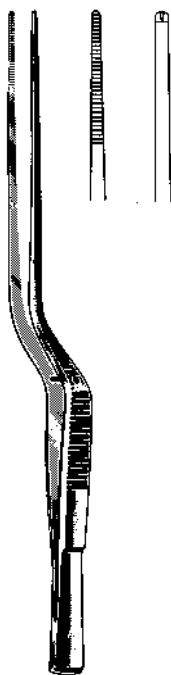

OM 38-0186 1x2 teeth  
 OM 38-0184 serrated

**CUSHING BAYONET TISSUE FORCEPS**

7 1/4" (184mm)

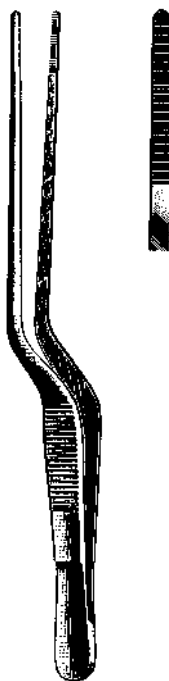

OM 39-0074  
 8 1/4" (210mm)  
 straight with serrated tips

**ADSON BAYONET FORCEPS**

8 1/4" (210mm)

# JEWELERS FORCEPS/SPLINTER FORCEPS



OM 39-0450  
#3  
4 3/4" (121mm)  
narrow fine



OM 39-0451  
#3C  
4 3/8" (111mm)  
narrow fine



OM 39-0452  
#4  
4 3/8" (111mm)  
fine



OM 39-0453  
#5  
4 3/8" (111mm)  
extra fine



OM 39-0455  
#6  
4 1/2" (114mm)  
angled pickup



OM 39-0456  
#7  
4 1/2" (114mm)  
curved fine

## SWISS JEWELERS STYLE FORCEPS

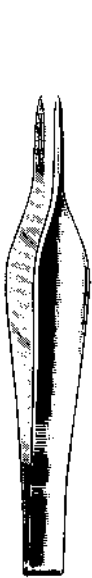

**FEILCHENFELD  
FORCEPS**  
Serrated

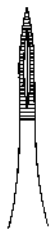

OM 39-0386

OM 39-0386  
3 1/4" (83mm)

OM 39-0390  
4 1/2" (114mm)



**PLAIN SPLINTER  
FORCEPS**  
Serrated



OM 39-0366

OM 39-0364  
3 1/2" (89mm)

OM 39-0366  
4 1/2" (114mm)



**CARMALT SPLINTER  
FORCEPS**  
4 1/4" (108mm) Serrated



OM 39-0410

Straight  
OM 39-0410

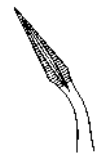

OM 39-0412

Curved  
OM 39-0412

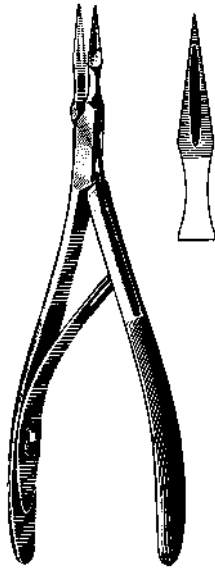

OM 39-0478  
6" (152mm)  
serrated

**VIRTUS SPLINTER FORCEPS**



OM 39-0534  
5" (127mm)  
trocar in reversible handle

OM 39-0536  
trocar point only

**VANGUARD SPLINTER LIBERATOR**

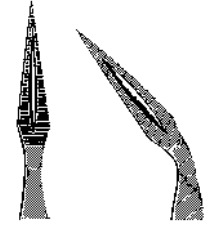

OM 39-0509    OM 39-0511

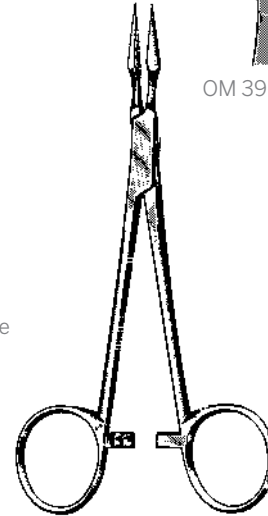

OM 39-0509  
5 1/2" (140mm)  
straight

OM 39-0511  
5 1/4" (133mm)  
45 degree angled

OM 39-0513  
5 1/2" (140mm)  
90 degree angled

**WILLIAMS SPLINTER FORCEPS**  
Serrated

Note: Our carbide needle holders have TC inserts firmly bonded to the inside of both jaws. We guarantee them for three years. The surface profiles of the inserts have been precision milled to provide the surgeon with a firm, non-slip grip on the needle. Because the carbide is harder than the steel needles, carbide needle holders last much longer than ordinary ones. The finger rings are gold plated for easy identification.



OM 41-0064



OM 41-0066

OM 41-0064  
smooth

OM 41-0065  
smooth carbide

OM 41-0066  
serrated

OM 41-0067  
serrated carbide

**HALSEY NEEDLE HOLDER**  
5" (127mm) Serrated



OM 41-0164



OM 41-0166

OM 41-0162  
5" (127mm)  
serrated

OM 41-0164  
5 3/4" (146mm)  
serrated

OM 41-0166  
5 1/2" (140mm)  
serrated carbide

**HEGAR BAUMGARTNER NEEDLE HOLDER**

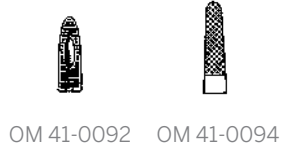
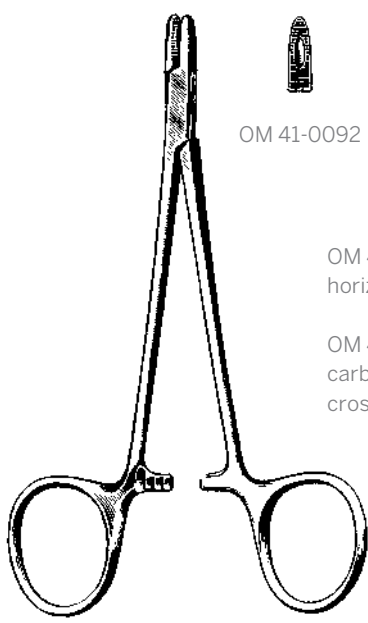

OM 41-0092  
horizontal serrations

OM 41-0094  
carbide  
cross serrations

**DERF NEEDLE HOLDER**

4 3/4" (121mm)

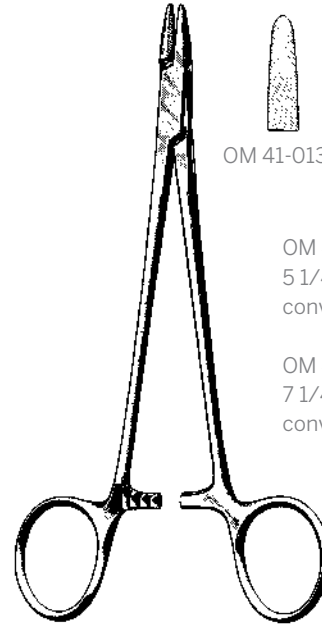

OM 41-0130  
5 1/4" (133mm)  
convex jaws

OM 41-0132  
7 1/4" (184mm)  
convex jaws

**BROWN NEEDLE HOLDER**

Fine serrations

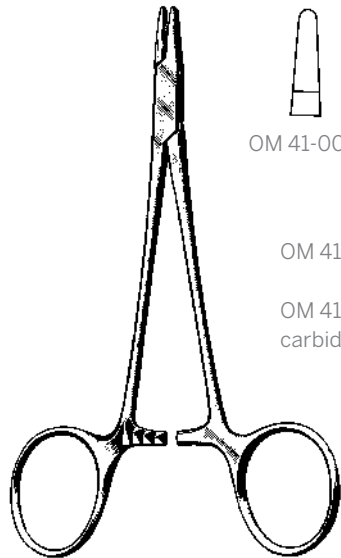

OM 41-0068

OM 41-0070  
carbide

**WEBSTER  
NEEDLE HOLDER**

5" (127mm) Smooth

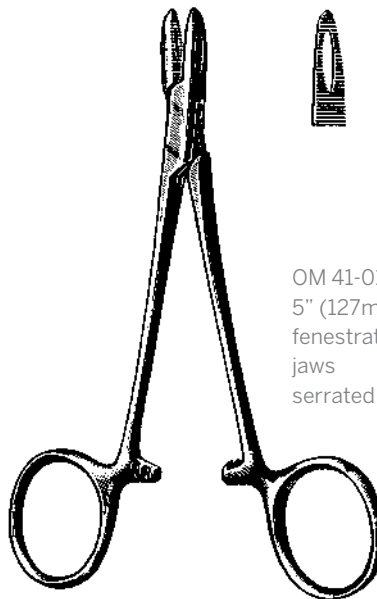

OM 41-0104  
5" (127mm)  
fenestrated  
jaws  
serrated

**COLLIER  
NEEDLE HOLDER**

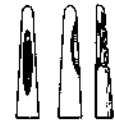
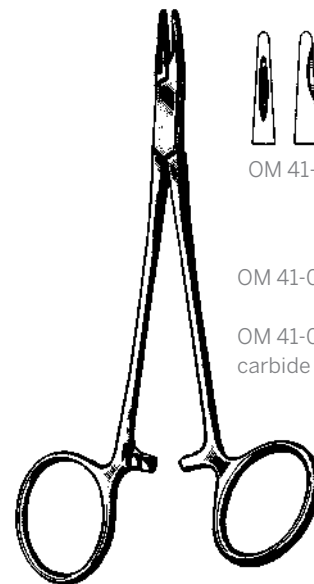

OM 41-0106

OM 41-0108  
carbide

**NIEVERT  
NEEDLE HOLDER**

5" (127mm) Smooth, one offset finger ring

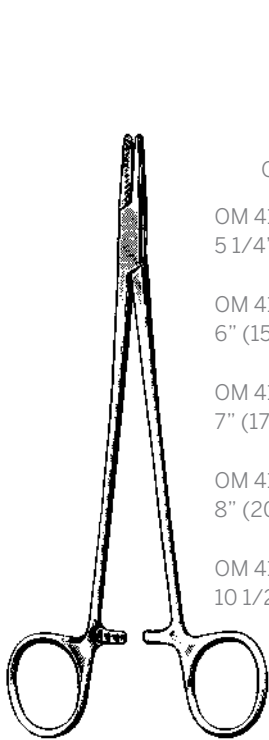

OM 41-0270

OM 41-0302

OM 41-0270  
5 1/4" (133mm)

Carbide  
OM 41-0300  
5" (127mm)

OM 41-0272  
6" (152mm)

OM 41-0302  
6" (152mm)

OM 41-0278  
7" (178mm)

OM 41-0308  
7" (178mm)

OM 41-0284  
8" (203mm)

OM 41-0314  
8" (203mm)

OM 41-0286  
10 1/2" (267mm)

OM 41-0316  
10 1/2" (267mm)

Left hand  
OM 41-0302L  
6" (152mm)

**MAYO HEGAR NEEDLE HOLDER**

Serrated

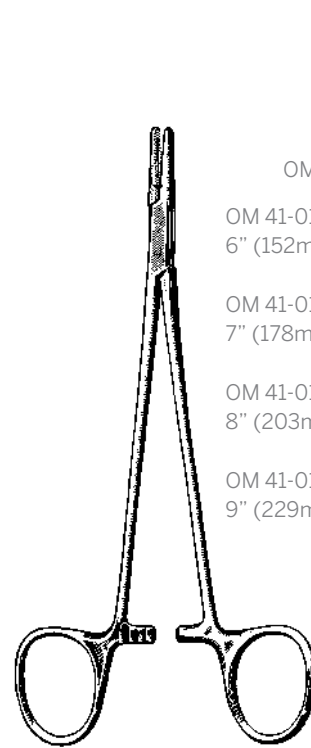

OM 41-0170

OM 41-0174

OM 41-0170  
6" (152mm)

Carbide  
OM 41-0174  
6" (152mm)

OM 41-0171  
7" (178mm)

OM 41-0175  
7" (178mm)

OM 41-0172  
8" (203mm)

OM 41-0176  
8" (203mm)

OM 41-0173  
9" (229mm)

OM 41-0178  
9" (229mm)

**CRILE-WOOD (DEBAKEY) NEEDLE HOLDER**

Serrated

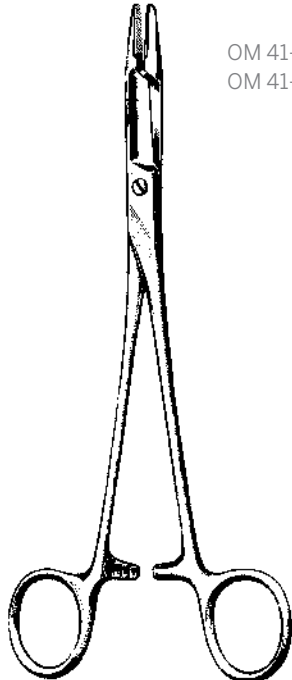

OM 41-0424  
OM 41-0440



OM 41-0428  
OM 41-0448

OM 41-0424  
4 3/4" (121mm) delicate serrated\*  
OM 41-0426  
4 3/4" (121mm) delicate smooth\*  
OM 41-0428  
5 1/2" (140mm) serrated  
OM 41-0432  
6 1/2" (165mm) serrated  
OM 41-0434  
7 1/2" (191mm) serrated

Carbide  
OM 41-0440  
4 3/4" (121mm) delicate serrated\*  
OM 41-0446  
4 3/4" (121mm) delicate smooth\*  
OM 41-0448  
5 1/2" (140mm) serrated  
OM 41-0452  
6 1/2" (165mm) serrated  
OM 41-0454  
7 1/2" (191mm) serrated

\* For suture sizes 5-0, 6-0, 7-0 only.

**OLSEN-HEGAR NEEDLE HOLDER**

Combination needle holder and suture scissors

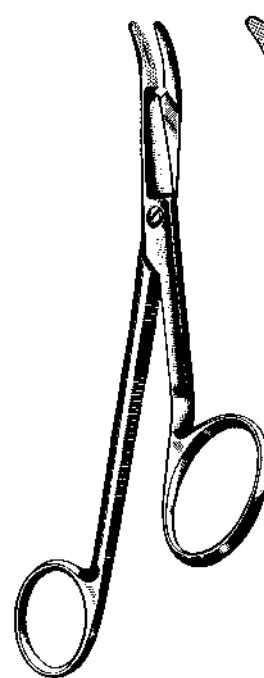

Curved  
OM 41-0333  
6 1/2" (165mm)  
one fenestrated  
jaw one angled  
finger ring

**GILLIES NEEDLE HOLDER**

Combination needle holder and suture scissors



# NEEDLE HOLDER

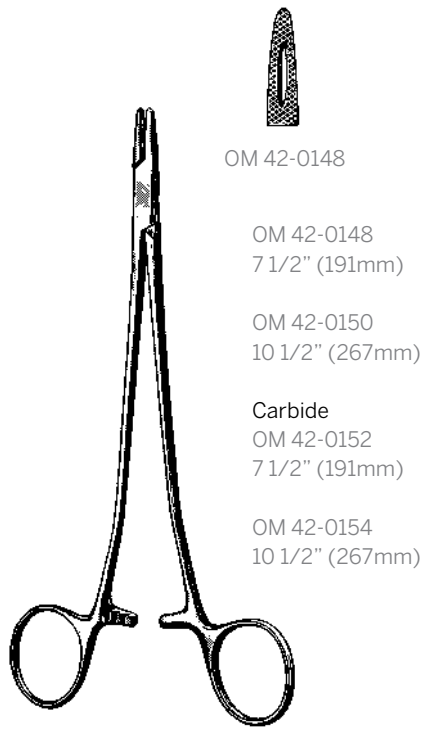

OM 42-0148

OM 42-0148  
7 1/2" (191mm)

OM 42-0150  
10 1/2" (267mm)

Carbide  
OM 42-0152  
7 1/2" (191mm)

OM 42-0154  
10 1/2" (267mm)

**SAROT NEEDLE HOLDER**  
Serrated

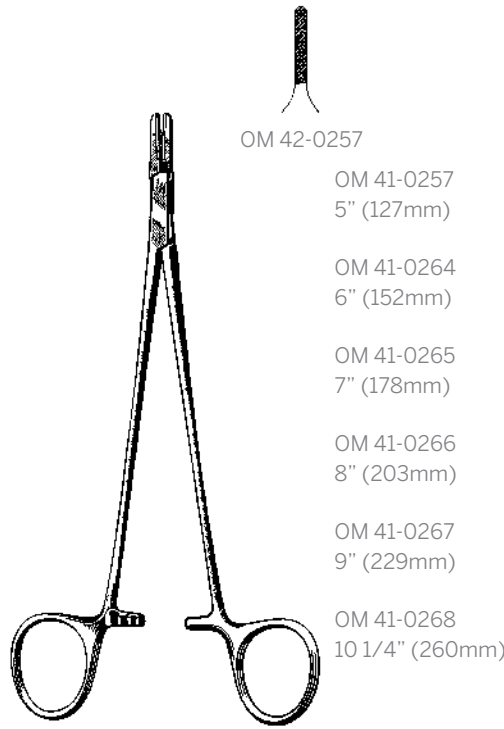

OM 42-0257

OM 41-0257  
5" (127mm)

OM 41-0264  
6" (152mm)

OM 41-0265  
7" (178mm)

OM 41-0266  
8" (203mm)

OM 41-0267  
9" (229mm)

OM 41-0268  
10 1/4" (260mm)

**RYDER NEEDLE HOLDER**  
Serrated carbide



OM 41-0240

OM 41-0240  
5" (127mm)

OM 41-0242  
6" (152mm)

OM 41-0244  
7" (178mm)

OM 41-0246  
8" (203mm)

OM 41-0248  
9" (229mm)

**RYDER MICRO NEEDLE HOLDER**  
Serrated carbide

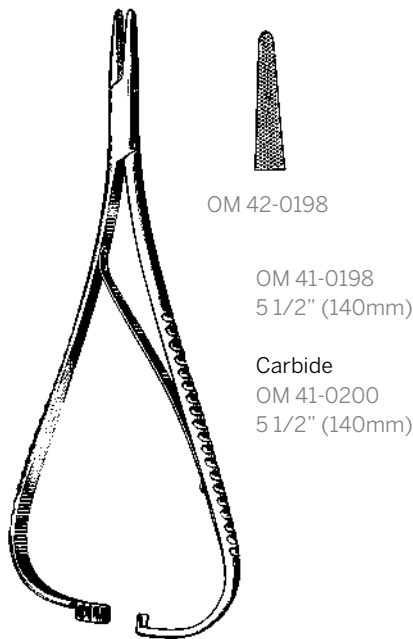

OM 42-0198

OM 41-0198  
5 1/2" (140mm)

Carbide  
OM 41-0200  
5 1/2" (140mm)

**MATHIEU NEEDLE HOLDER**  
Serrated

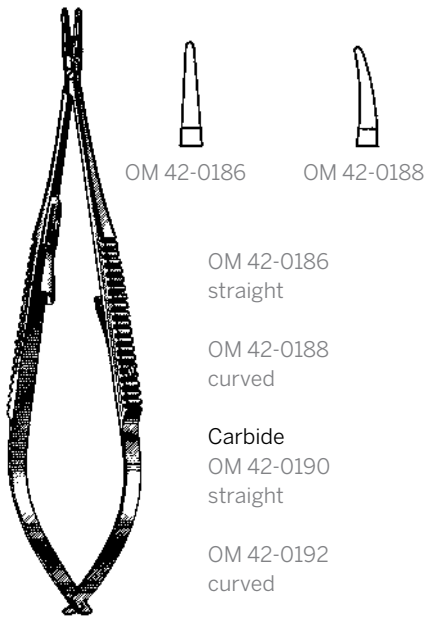

OM 42-0186

OM 42-0186  
straight

OM 42-0188  
curved

Carbide  
OM 42-0190  
straight

OM 42-0192  
curved

**CASTROVIEJO MICRO NEEDLE HOLDER**  
5 1/2" (140mm) smooth, with lock

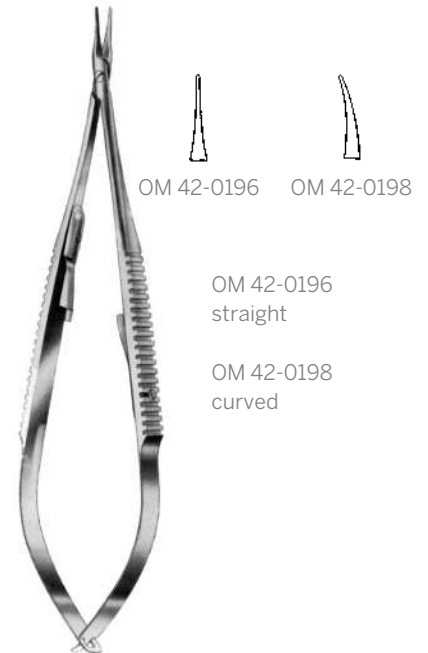

OM 42-0196

OM 42-0196  
straight

OM 42-0198  
curved

**CASTROVIEJO MICRO NEEDLE HOLDER**  
5 1/2" (140mm) extra delicate, smooth, with lock

OAL = Overall Length  
 WL = Working Length  
 FR = French Gauge (1 french = .33mm)

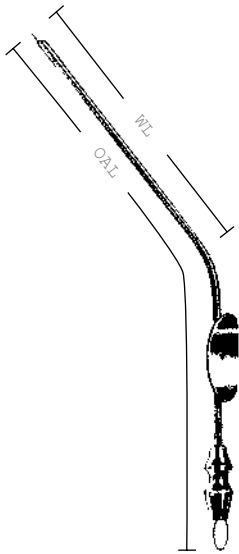

	OAL	FR	WL
OM 42-0832	5 1/2" (140mm)	3	75mm
OM 42-0834	5 1/2" (140mm)	5	75mm
OM 42-0836	5 1/2" (140mm)	7	75mm

**BARON SUCTION TUBE**

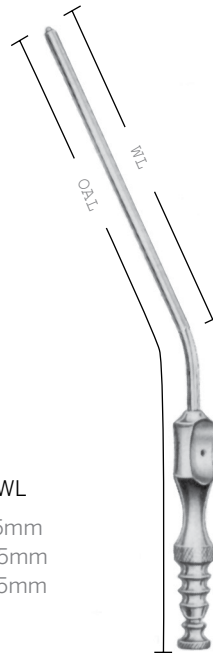

	OAL	FR	WL
OM 42-0823	7" (178mm)	6	90mm
OM 42-0824	7" (178mm)	7	90mm
OM 42-0825	7" (178mm)	8	90mm
OM 42-0826	7" (178mm)	10	90mm
OM 42-0827	7" (178mm)	11	90mm
OM 42-0830	7" (178mm)	12	90mm
OM 42-0823L	9" (229mm)	6	130mm
OM 42-0824L	9" (229mm)	7	130mm
OM 42-0825L	9" (229mm)	8	130mm
OM 42-0826L	9" (229mm)	10	130mm
OM 42-0827L	9" (229mm)	11	130mm
OM 42-0830L	9" (229mm)	12	130mm

**FRAZIER SUCTION TUBE**

Angled 30°

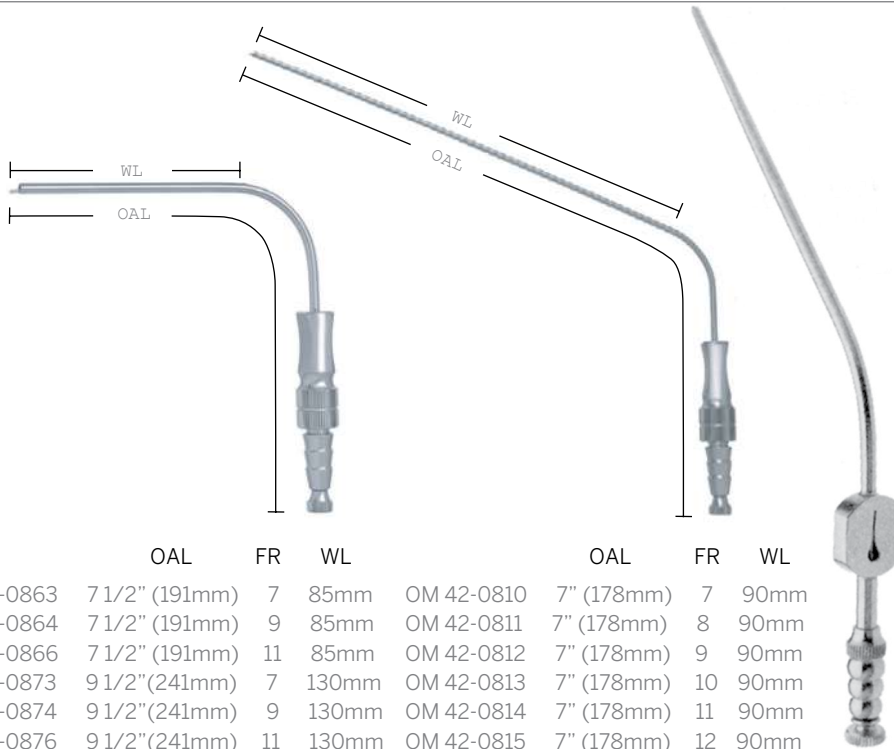

*Tear drop opening allows surgeon to regulate force of suction.*

	OAL	FR	WL		OAL	FR	WL
OM 42-0863	7 1/2" (191mm)	7	85mm	OM 42-0810	7" (178mm)	7	90mm
OM 42-0864	7 1/2" (191mm)	9	85mm	OM 42-0811	7" (178mm)	8	90mm
OM 42-0866	7 1/2" (191mm)	11	85mm	OM 42-0812	7" (178mm)	9	90mm
OM 42-0873	9 1/2" (241mm)	7	130mm	OM 42-0813	7" (178mm)	10	90mm
OM 42-0874	9 1/2" (241mm)	9	130mm	OM 42-0814	7" (178mm)	11	90mm
OM 42-0876	9 1/2" (241mm)	11	130mm	OM 42-0815	7" (178mm)	12	90mm

**FRAZIER SUCTION TUBE**

Angled 90°

**FRAZIER SUCTION TUBE**

Angled 75°

**FUKUSHIMA SUCTION TUBE**

SUCTION TUBES/SCALPEL HANDLES

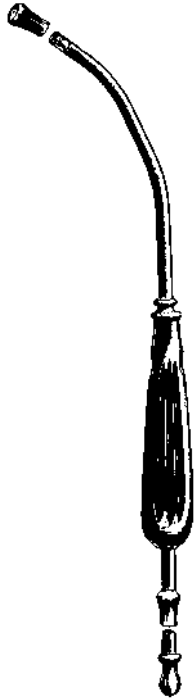

OM 58-0228  
11 1/2" (292mm)  
chrome

OM 58-0230  
front tip only

**YANKAUER SUCTION TUBE**

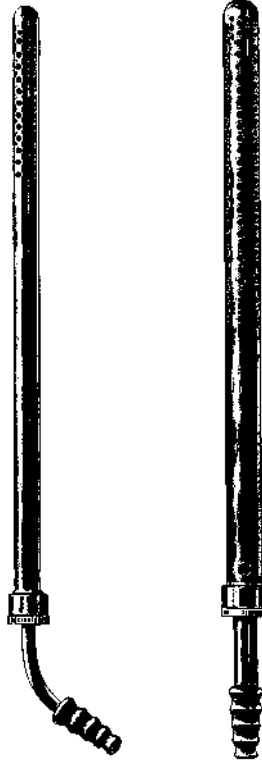

1 french = .33mm

OM 42-0844  
23 french curved

OM 42-0852  
30 french straight

**POOLE SUCTION TUBE**  
9" (229mm) Chrome



OM 29-0070  
for blades 61 through 67

**MINI SCALPEL HANDLE  
#3K**



OM 29-0073

**SCALPEL HANDLE MINI  
(BEAVER) #3K 6"**



OM 29-0071

**SCALPEL HANDLE MINI  
(BEAVER) #3K 5"**



OM 29-0058  
for blades  
10 through 15

**SCALPEL HANDLE #3**



OM 29-0059  
mm and cm graduations  
for blades 10 through 15

**SCALPEL HANDLE #3**



OM 29-0060  
for blades  
20 through 25

**SCALPEL HANDLE #4**



OM 29-0061  
extra long  
8 1/2" (216mm)  
for blades 10 through 15

**SCALPEL HANDLE #3L**



OM 29-0062  
for blades 10 through 15

**SCALPEL HANDLE #7**



OM 29-0064  
extra fine  
for blades 10 through 15

**SCALPEL HANDLE #9**



- OM 42-0608 4 1/2" (114mm)
- OM 42-0610 5" (127mm)
- OM 42-0612 5 1/2" (140mm)
- OM 42-0614 6" (152mm)
- OM 42-0616 8" (203mm)
- OM 42-0618 10" (254mm)
- OM 42-0620 12" (305mm)

**PROBE WITH EYE**  
Malleable stainless

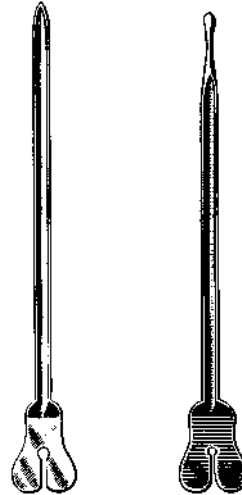

- With tongue tie
- OM 42-0646 4 1/2" (114mm)
  - OM 42-0647 5" (127mm)
  - OM 42-0648 5 1/2" (140mm)
  - OM 42-0649 6" (152mm)

- With probe and tongue tie
- OM 42-0654 5" (127mm)
  - OM 42-0655 5 1/2" (140mm)
  - OM 42-0656 6" (152mm)

**GROOVED DIRECTORS**



- OM 28-0460  
7" (178mm) small
- OM 28-0468  
8" (203mm) large

**TAYLOR  
PERCUSSION HAMMER**

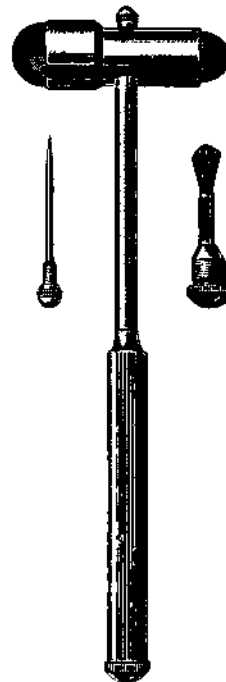

- OM 28-0492  
7 3/4" (197mm)  
chrome with brush and needle

**BUCK  
NEUROLOGICAL HAMMER**

**UTILITY CLIP MINI**

OM CK-10

**UTILITY CLIP MINI LARGE**

OM CK-40



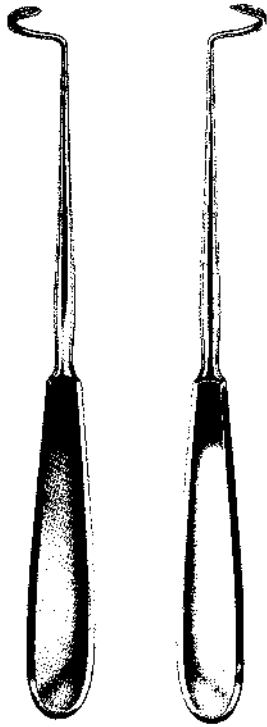

OM 42-0558 blunt left  
OM 42-0560 blunt right  
OM 42-0562 sharp left  
OM 42-0564 sharp right

**DESCHAMPS LIGATURE CARRIER**  
8"(203mm)



OM 53-0450  
0.12mm  
1x2 teeth

OM 53-0456  
0.5mm  
1x2 teeth

**CASTROVIEJO MICRO TYING FORCEPS**  
4"(102mm) Straight with tying platform

*Bipolar forceps  
Available in most styles and tip sizes.*



OM 68-0026  
4"(102mm)  
8mm platform  
0.5mm tip

**JEWELERS FORCEPS**