



ORTHOMED

The Surgical Instrument Specialists

OrthoMed, Inc.

Orthomed is a ISO 13485/2016 certified company and has been providing Healthcare Professionals quality products since 1970. We recently celebrated our 50th anniversary and want to recognize the employees, sales partners, distributors, and most of all the thousands of customers who have trusted us to provide the best quality products and service over the last 50 plus years.

We continue to provide the best service and quality instruments at the most competitive prices. Customer service is our top priority which is why our Mission statement says, "customer service above all else." We pride ourselves on being the Surgical Instrument Specialists and being a complete source for all your instrument needs. We cross-reference most instrument companies' part numbers and can often source the hard-to-find or discontinued items. We are happy to do the research if you can provide a crossreference number or pictures.

The instruments featured in this catalog are primarily made in Germany with the highest quality German stainless steel and crafted to rigorous and exacting standards. We demand from our instrument makers: precision, reliability, consistency of pattern, and uniform service.

Guarantee

OrthoMed, Inc. instruments are guaranteed for life against manufacturing defects of material or workmanship. This guarantee is void if instruments are not maintained or repaired properly, or if they are not used for their intended surgical purpose. Tungsten carbide inserts on scissors, needle holders, and wire cutters are guaranteed for three years. Replacement parts, such as springs, are guaranteed for one year.

Customization

We also provide customization and modification services. These may be as simple as serration of blades, etching, color coding for instrument identification or complex instrument manufacturing in small quantities.

Ordering

Orders may be placed by contacting our customer service department at 503-234-9691 or toll free 800-547-5571. Orders can also be faxed to 503-234-8629 or emailed to custserv@orthomedinc.com. OrthoMed, Inc. also has authorized sales representatives and distributors.

Please call customer service for the sales representative or distributor serving your area.

Return Policy

OrthoMed, Inc. requires a return goods authorization on all returns. Most returns will be authorized unless they are over 30 days from date of invoice, have been used, processed or sterilized, or are special or custom orders. A restocking fee may be charged for items with missing packaging or labeling. To receive authorization for the return of unused merchandise contact your OrthoMed, Inc. sales representative or call customer service at 800-547-5571.

OrthoMed, Inc.: The Surgical Instrument Specialists

We are proud to introduce this catalog with more than 4,000 products featuring one of the most comprehensive instrument lines in the industry. At OrthoMed, Inc. we have a passion for surgical instruments and truly want to be known as the Surgical Instrument Specialists. At OrthoMed, Inc. we will continue to provide the innovative instruments that surgeons demand for the ever evolving new surgical techniques. Please note new instruments for MIS (minimally invasive surgery) that are in Section X in this catalog are now available through OrthoMed, Inc. We also have a large number of spinal instruments for this growing specialty.

In addition to our premium Operating Room instruments featured in this catalog we provide middle and economy grade instruments for Central Supply, the emergency room, and the floors. These instruments also must pass strident manufacturing processes certified in conjunction with FDA and CE standards. Many instruments used in these areas may not need to be premium grade when a lower cost instrument will suffice. Our goal at OrthoMed, Inc. is to provide all your surgical instrument needs and continue to build on the trust and confidence that we have earned over the last 50+ years.

Instrument Longevity Through Proper Care

Your purchase of OrthoMed, Inc. instruments represents a considerable investment. By following these guidelines you will protect your investment and ensure many years of productive and satisfactory performance.

Maintaining the Surface

OrthoMed, Inc. stainless steel surgical instruments are made of corrosion resistant, high-grade specialty steels that are especially selected to meet the varying requirements of cutting, clamping, retracting and chiseling.

A special characteristic of these steels is that they form passive layers on the instrument's surface, which protect against corrosion. These layers act as an invisible patina and with repeated use and exposure to air, the instruments become increasingly corrosion resistant.

While every effort is made during the manufacturing process to ensure that instruments are corrosion resistant, the real key to longevity is proper maintenance. In that regard, you must do your part by caring for your instruments. In a sense, the "stainless steel" is a misnomer, one which should not be taken literally. When not properly treated, steel can rust or stain, reducing the life of the instrument or rendering it useless. The following sections outline proper instrument care.

New Instruments

Newly purchased instruments must be cleaned, lubricated and autoclaved immediately before use.

Correct Use

Obvious as it sounds, it bears repeating: Instruments are designed for a particular purpose and should be used only for that purpose. Even the strongest instrument can be damaged when used inappropriately, i.e., when a rongeur is used to cut wire.

Water and Stainless Steel

Ordinary tap water contains minerals that can cause discoloration and staining. Therefore, we recommend the use of distilled water for cleaning, disinfecting, sterilizing and rinsing instruments. To avoid staining, use a cleaning solution with pH near neutral (7).

Manual Cleaning and Soaking

When handling instruments, be very careful not to damage their fine tips and mechanisms. If instruments have been exposed to blood, tissue, saline or other foreign matter, you must rinse them in warm (not hot) water before these substances are allowed to dry. After rinsing, immerse them in a cleaning and disinfecting solution.

Because many compounds including certain chemicals, are highly corrosive to stainless steel, rinse and dry instruments immediately, in case they have come in contact with any potentially harmful substances.

If no ultrasonic cleaner is available, clean the instrument very carefully. Pay particular attention when cleaning boxlocks, serrations, hinges and other hard-to-reach areas. What's more, use nylon (not steel) brushes, such as OM 39- 0684, and warm (not hot) cleaning solutions. Follow the manufacturer's instructions for the preparation of the cleaning solutions. Remember to change these solutions daily.

Ultrasonic Cleaning

Ultrasonic cleaning is the most effective way to clean your instruments. To maximize its effectiveness, your instruments should be cleaned of all visible debris before they are put into an ultrasonic cleaner. Please note that chrome-plated instruments may rust if they are not dried and lubricated immediately after sterilization. In addition, we recommend the following:

- Do not mix dissimilar metals, i.e., chrome and stainless, in the same cycle.
- Open all instruments so ratchets and boxlocks are accessible.
- Avoid piling instruments on top of each other when loading.
- Remove and rinse off instruments immediately after the cycle is finished.
- Dry instruments immediately after rinsing and allow them to air-dry thoroughly.
- Lubricate all moving parts.

Instrument Checkup

The best time to review the condition of your instruments is after they have been cleaned and lubricated and have cooled off. Consider the following:

Function:

Scissors must cut cleanly and close properly. Needle holders and clamps must engage properly and meet correctly at the tips.

Surface:

Carefully inspect surfaces for any sign of staining, cracking or other irregularities. Common sources of staining are:

Inadequate cleaning

- Mixing dissimilar metals
- Impurities in the water
- Unsuitable or improper preparation and usage of cleaning and disinfecting or maintenance agents
- Non-compliance with operating procedures of cleaning and sterilizing equipment

Aluminum Trays

To avoid development of “aluminum salt” on your Al-trays, use only distilled water in your autoclave. Already developed “aluminum salt” is very difficult to remove which might cause damage to the anodized Al-surface. Any instrument or tray should be cleaned of debris with a non-acid detergent (neutral pH) prior to autoclaving.

Lubrication and Autoclaving

All instruments must be properly cleaned before autoclaving. Their moving parts, such as boxlocks and hinges, should be well lubricated. Be careful to use surgical lubricants and not industrial oils. Always sterilize instruments in the open, unlocked position. We recommend that instruments be wrapped in cloth and then placed in the container, or that a cloth be put on the bottom of the pan to absorb moisture. The cloth should be pH(7) neutral and have no residue of detergents. Finally, avoid sudden cooling of your instruments.

Cold Sterilizing or Disinfecting

Prolonged immersion in disinfecting or sterilizing solution can damage your surgical instruments. We recommend that you do not soak your instruments for longer than 20 minutes. To render the instruments sterile and ready for use, use an autoclave cycle.

Caution:

- Instruments with tungsten carbide inserts, such as wire cutters, needle holders, and TC scissors, should never be immersed in sterilizing solutions containing Benzyl Ammonium Chloride (BAC). BAC will soften and dissolve the tungsten carbide.
- Never use bleach as it will cause severe pitting.

Storage

Once your instruments are thoroughly dry, store them in a clean, dry environment. Never put them in areas where chemicals may emit corrosive vapors or where temperature and moisture variations could cause condensation on the instrument.

OrthoMed, Inc. Instrument Care Checklist

1. Rinse and soak soiled instruments immediately after use. Thoroughly clean before autoclaving.
2. Autoclave and sterilize instruments in an open position.
3. Do not stack or entangle instruments.
4. Follow recommendations made by equipment and solutions manufacturers.
5. Keep instruments properly lubricated.
6. Inspect instruments regularly.
7. If you experience a problem, at any stage of the instrument care process, please consult your OrthoMed representative.

ORTHOMED

The Surgical Instrument Specialists

(800) 547-5571

INTRODUCTION

SECTION A	General Instruments
SECTION D	Foot and Ankle
SECTION E	Cast Room Instruments
SECTION F	Bone Files and Rasps
SECTION G	Elevators, Awls, and Bone Hooks
SECTION H	Bone Curettes
SECTION I	Skin Hooks and Retractors
SECTION J	Osteotomes, Chisels, and Gouges
SECTION K	Mallets, Tamps, and Impactors
SECTION L	Bone Holding
SECTION M	Bone Cutting
SECTION N	Rongeurs
SECTION O	Spinal Rongeurs and Punches
SECTION P	Cartilage and Tendon Instruments
SECTION Q	Arthroscopic
SECTION R	Wire and Pin Implants
SECTION S	Wire and Pin Management
SECTION T	Bone Screws and Plates
SECTION U	Bone Screw and Plate Management
SECTION W	Measuring Devices
SECTION X	MIS Instruments
SECTION Y	Sterile Processing Containers and Brushes
SECTION Z	Miscellaneous
SECTION AA	Trays and Racks
SECTION BB	Instrument Sets
	Measurement Conversion Charts
	Alphabetical Index
	Numerical Index

GENERAL INSTRUMENTS



SECTION A

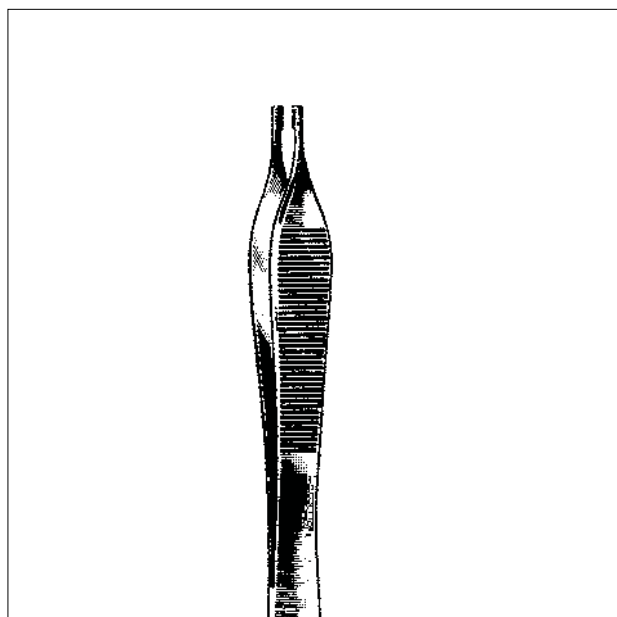

To dissect, hold, clamp, manipulate and suture soft tissue.

ORTHO+MED
The Surgical Instrument Specialists

CONTENTS

Super Cut Scissors	1-3
Operating Scissors	4-7
Dissecting Scissors	4-9
Suture scissors	9-10
Tungsten Carbide Scissors	11-12
Bandage Scissors	13
Utility Scissors/Wire Scissors	14-15
Hemostatic Forceps	15-19
Intestinal Forceps	20-21
Tubing and Utility Forceps	21-20
Towel and Sponge Forceps	22-23
Dressing & Tissue Forceps	23-27
Splinter Forceps	28-29
Needle Holders	29-32
Suction Tubes	33-34
Scalpel Handles	34-35
Probes/Suture Instruments	36-38
Bi-Polar Instruments	38

SUPER-CUT SCISSORS

Super-Cut Scissors represent a truly remarkable advance in scissors technology. Using the finest surgical steel, the latest heat treating methods and master craftsmanship, the upper blade of the scissors is ground to a razor-sharp edge. This process creates scissors with an unprecedented smooth and effective cutting action.

Benefits of Super-Cut Scissors:

- Cut through soft and fibrous tissue without effort.
- Superb control permits precision in dissection.
- Less hand fatigue for the surgeon and less trauma for the patient.
- Retain sharpness longer than ordinary scissors.
- Ring handles are black-coated for easy identification.
- Fully autoclavable.
- Backed by OrthoMed's lifetime guarantee.
- Not recommended for fiberglass or plaster splints.

Surgeons who use our Super-Cut Scissors are convinced of their superior performance and won't do without them on their surgical trays.

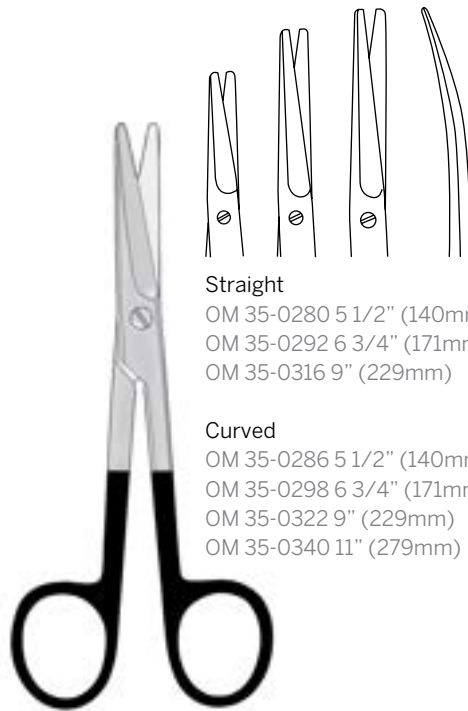

Straight
 OM 35-0280 5 1/2" (140mm)
 OM 35-0292 6 3/4" (171mm)
 OM 35-0316 9" (229mm)

Curved
 OM 35-0286 5 1/2" (140mm)
 OM 35-0298 6 3/4" (171mm)
 OM 35-0322 9" (229mm)
 OM 35-0340 11" (279mm)

SUPER-CUT MAYO SCISSORS
 Beveled blades, blunt points

Flat, blunt scissors for dissecting soft tissue.



Straight
 OM 35-0364 4 1/2" (114mm) blunt points

Curved
 OM 35-0370 4 1/2" (114mm) blunt points

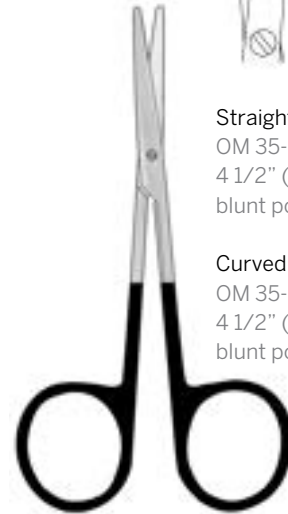

SUPER-CUT BABY METZENBAUM SCISSORS



SUPER-CUT METZENBAUM SCISSORS
 Blunt point

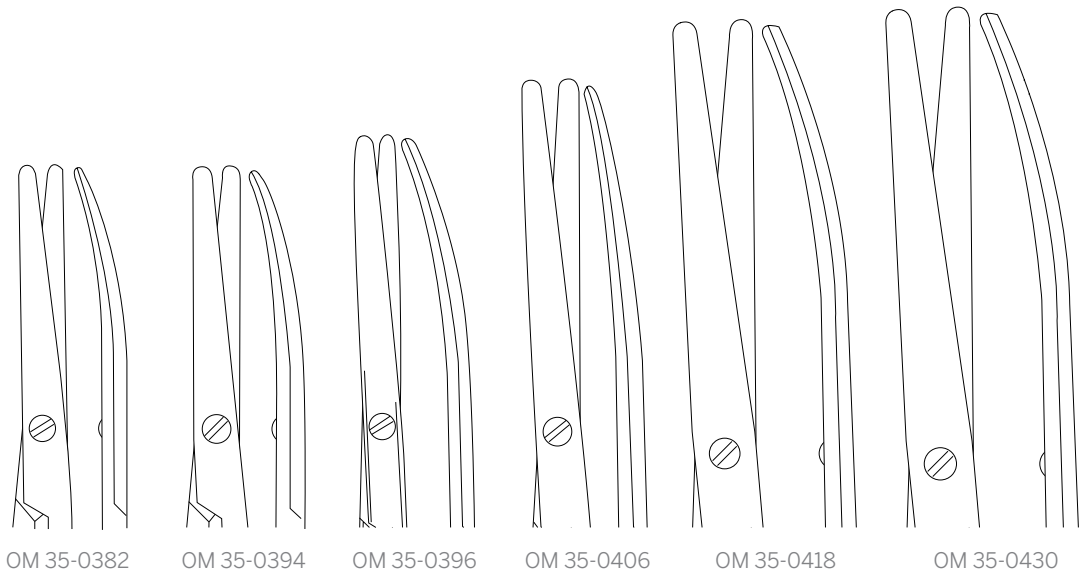

Straight
 OM 35-0380 6" (152mm)
 OM 35-0392 7" (171mm)

Curved
 OM 35-0382 6" (152mm)
 OM 35-0394 7" (178mm)
 OM 35-0396 7" (178mm)
 OM 35-0406 8" (203mm)
 OM 35-0418 9" (229mm)
 OM 35-0430 11" (279mm)

delicate

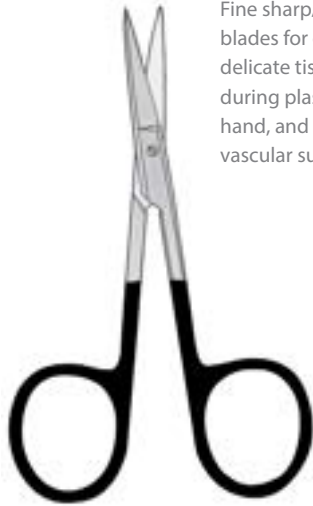

Fine sharp/sharp blades for cutting delicate tissue during plastic, hand, and minor vascular surgery.

SUPER-CUT IRIS SCISSORS
Sharp points

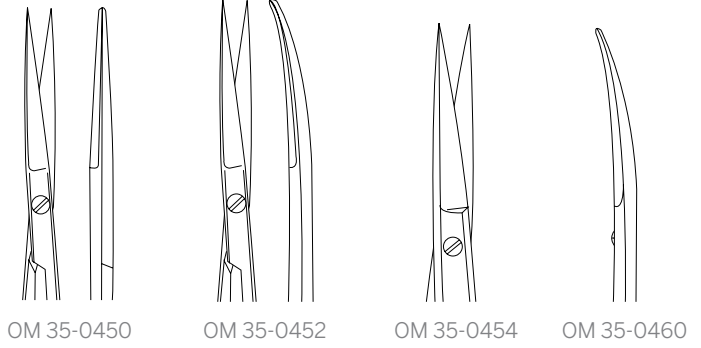

Straight
OM 35-0450 3 1/2" (89mm) delicate
OM 35-0454 4 1/2" (114mm)

Curved
OM 35-0452 3 1/2" (89mm) delicate
OM 35-0460 4 1/2" (114mm)

Delicate short narrow tips for dissecting fine tissue.



SUPER-CUT STEVENS SCISSORS
Blunt points

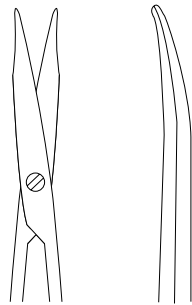

Straight
OM 35-0484 4 1/2" (114mm)

Curved
OM 35-0490 4 1/2" (114mm)
OM 35-0494 5 1/4" (133mm)



SUPER-CUT JAMISON SCISSORS
6 1/4" (159mm)

Very delicate blunt scissors with long handles for fine tissue dissection.



OM 35-0496 curved blunt points very delicate

OrthoMed developed these remarkably sharp scissors in response to the demands of doctors, nurses, and other O.R. personnel.

Hospital tests show that these scissors cut multiple layers of stockinette bandages, drapes, and moleskin with ease.

- Very little strength is required for cutting, putting less strain on thumb and forearm.
- Perfect cutting control because you don't have to force them to cut.
- Scissors cut faster, saving critical time in the O.R.
- Retain their sharpness longer than ordinary scissors.
- Not recommended for cutting plaster.

The delicate offset shanks and the sharp Super-Cut edge provide better leverage. The fine knob slides easily under finger and toe bandages.



OM 35-0202
5 1/2" (140mm)
shanks angled on side

SUPER-CUT HI-LEVEL BANDAGE SCISSORS

Cuts bandages and multiple layers of dressing with ease. Razor-sharp blades reduce hand fatigue.

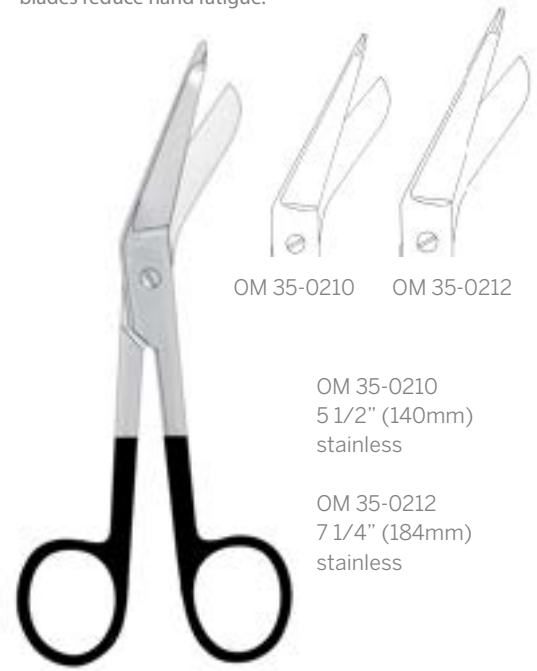

OM 35-0210 OM 35-0212

OM 35-0210
5 1/2" (140mm)
stainless

OM 35-0212
7 1/4" (184mm)
stainless

SUPER-CUT LISTER BANDAGE SCISSORS

All the benefits of our Super-Cut Lister Scissors plus an oversized finger ring, which helps relieve pressure on the third metacarpal.



OM 35-0214
8" (203 mm)
stainless

SUPER-CUT LISTER BANDAGE SCISSORS WITH LARGE FINGER RING

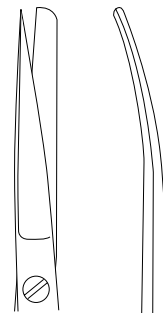
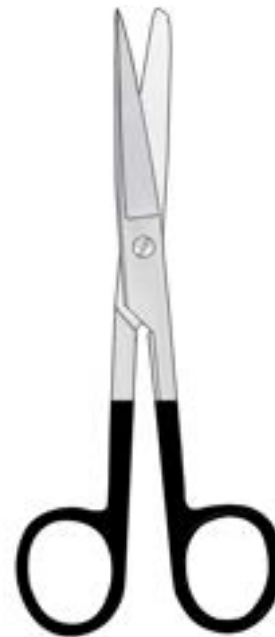

Straight
OM 35-0220
5 1/2" (140mm)
sharp/blunt

Curved
OM 35-0250
5 1/2" (140mm)
sharp/blunt

SUPER-CUT OPERATING SCISSORS

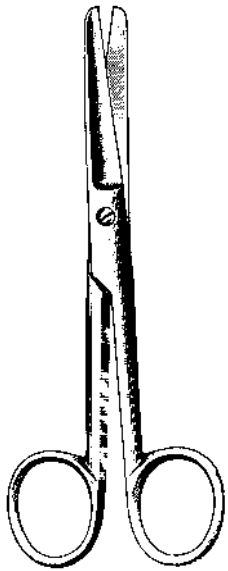

OPERATING SCISSORS

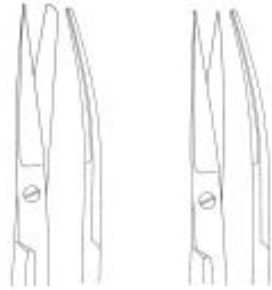

OM 33-0470 OM 33-0472



OM 33-0474

Straight

- OM 33-0300 4 1/2" (114mm) sharp/blunt
- OM 33-0302 4 1/2" (114mm) sharp/sharp
- OM 33-0304 4 1/2" (114mm) blunt/blunt
- OM 33-0310 5" (127mm) sharp/blunt
- OM 33-0312 5" (127mm) sharp/sharp
- OM 33-0314 5" (127mm) blunt/blunt
- OM 33-0320 5 1/2" (140mm) sharp/blunt
- OM 33-0322 5 1/2" (140mm) sharp/sharp
- OM 33-0324 5 1/2" (140mm) blunt/blunt
- OM 33-0370 6 1/2" (165mm) sharp/blunt
- OM 33-0372 6 1/2" (165mm) sharp/sharp
- OM 33-0374 6 1/2" (165mm) blunt/blunt

Curved

- OM 33-0470 4 1/2" (114mm) sharp/blunt
- OM 33-0472 4 1/2" (114mm) sharp/sharp
- OM 33-0474 4 1/2" (114mm) blunt/blunt
- OM 33-0482 5" (127mm) sharp/blunt
- OM 33-0484 5" (127mm) sharp/sharp
- OM 33-0486 5" (127mm) blunt/blunt
- OM 33-0490 5 1/2" (140mm) sharp/blunt
- OM 33-0492 5 1/2" (140mm) sharp/sharp
- OM 33-0494 5 1/2" (140mm) blunt/blunt
- OM 33-0520 6 1/2" (165mm) sharp/blunt
- OM 33-0522 6 1/2" (165mm) sharp/sharp
- OM 33-0524 6 1/2" (165mm) blunt/blunt



PLASTIC SURGERY SCISSORS

4 3/4" (121mm)



OM 33-0532 OM 33-0538

Straight

- OM 33-0532 sharp/sharp
- OM 33-0534 sharp/blunt
- OM 33-0536 blunt/blunt

Curved

- OM 33-0538 sharp/sharp
- OM 33-0540 sharp/blunt
- OM 33-0542 blunt/blunt

Angled on side

- OM 33-0544 sharp/sharp



DEAVER SCISSORS

5 1/2" (140mm)



OM 34-0142

Straight

- OM 34-0140 sharp/blunt
- OM 34-0142 sharp/sharp

Curved

- OM 34-0150 sharp/blunt
- OM 34-0152 sharp/sharp

Most scissors can be serrated upon request.



Straight
 OM 53-0330 6" (152mm)
 OM 53-0332 7" (179mm)

Curved
 OM 53-0331 6" (152mm)
 OM 53-0333 7" (179mm)

REYNOLDS SCISSORS
 blunt points

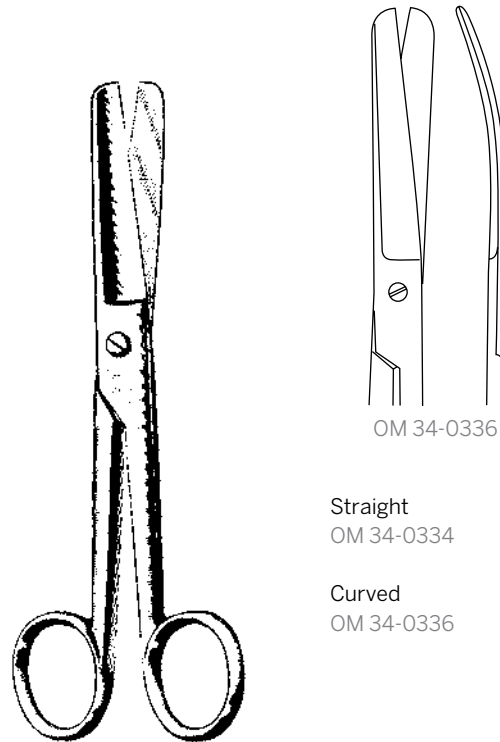

OM 34-0336

Straight
 OM 34-0334

Curved
 OM 34-0336

DOYEN ABDOMINAL SCISSORS
 7" (178mm)

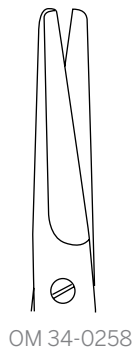
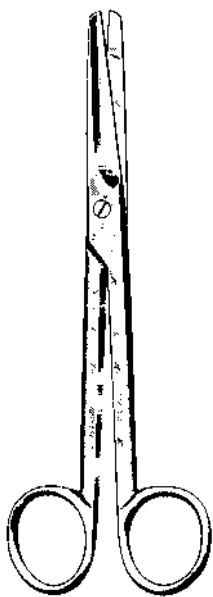

OM 34-0258

Straight
 OM 34-0256 5 1/2" (140mm)
 OM 34-0260 6 3/4" (171mm)
 OM 34-0292 9" (229mm)

Curved
 OM 34-0258 5 1/2" (140mm)
 OM 34-0262 6 3/4" (171mm)
 OM 34-0294 9" (229mm)

Serrated
 OM 34-0280 6 3/4" (171mm)
 OM 34-0282 6 3/4" (171mm)

MAYO SCISSORS
 Beveled blades

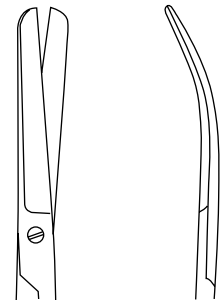

OM 67-0168 OM 67-0174

Straight
 OM 67-0164 sharp/sharp
 OM 67-0166 sharp/blunt
 OM 67-0168 blunt/blunt

Curved
 OM 67-0170 sharp/sharp
 OM 67-0172 sharp/blunt
 OM 67-0174 blunt/blunt

SIMS SCISSORS
 8" (203mm)

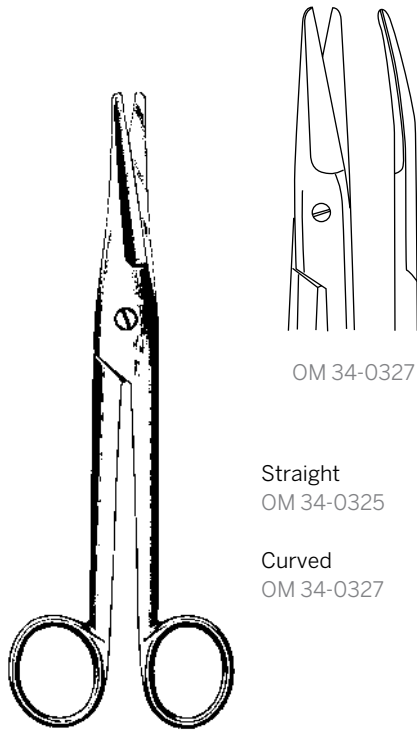

OM 34-0327

Straight
OM 34-0325

Curved
OM 34-0327

MAYO-NOBLE SCISSORS
6 1/2" (165mm) Beveled blades

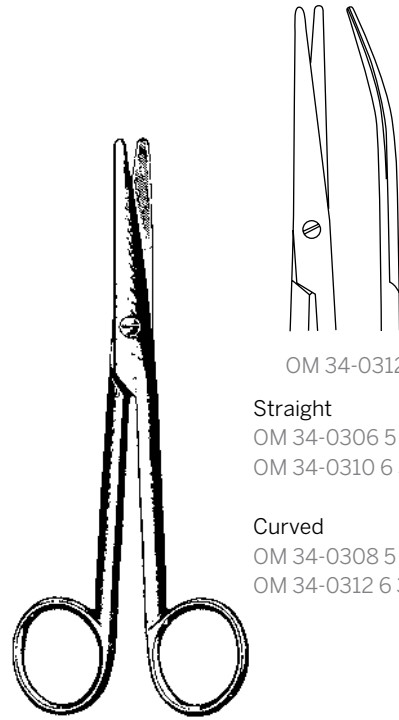

OM 34-0312

Straight
OM 34-0306 5 1/2" (140mm)
OM 34-0310 6 3/4" (171mm)

Curved
OM 34-0308 5 1/2" (140mm)
OM 34-0312 6 3/4" (171mm)

MAYO-STILLE SCISSORS
Rounded blades



OM 34-0338

FERGUSON SCISSORS
7" (178mm)
Angled on flat

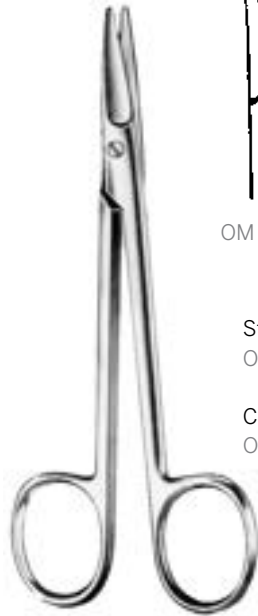

OM 34-0354

Straight
OM 34-0348

Curved
OM 34-0354

SISTRUNK SCISSORS
5" (127mm) Delicate

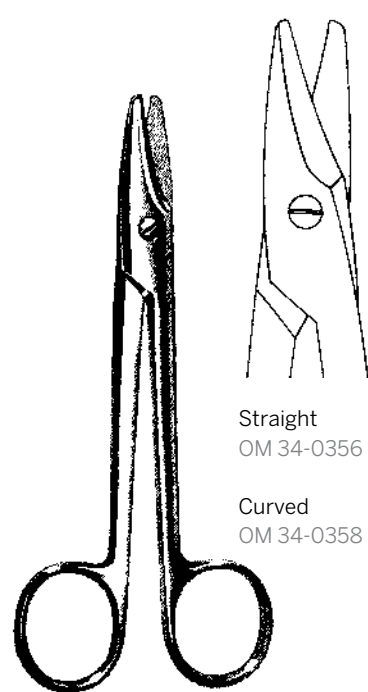

Straight
OM 34-0356

Curved
OM 34-0358

SISTRUNK SCISSORS
5 1/2" (140mm) Heavy pattern

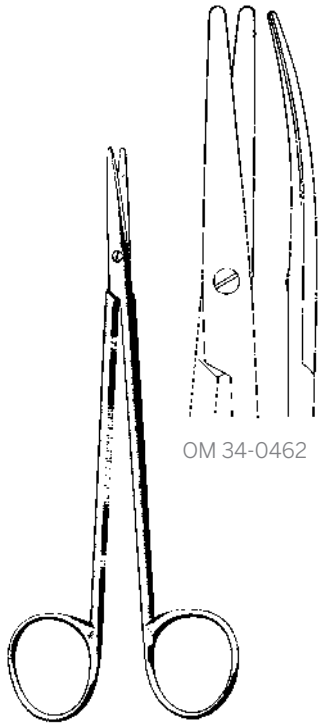

OM 34-0462

Straight

- OM 34-0436 4 1/2" (114mm)
- OM 34-0458 6" (152mm)
- OM 34-0466 7" (178mm)
- OM 34-0472 8" (203mm)
- OM 34-0476 9" (229mm)
- OM 34-0486 11" (279mm)

Curved

- OM 34-0438 4 1/2" (114mm)
- OM 34-0492 5 3/4" (146mm) delicate
- OM 34-0462 6" (152mm)
- OM 34-0470 7" (178mm)
- OM 34-0494 7" (178mm) delicate
- OM 34-0474 8" (203mm)
- OM 34-0478 9" (229mm)
- OM 34-0488 11" (279mm)

METZENBAUM SCISSORS

blunt points

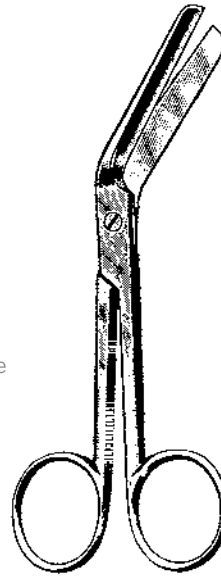

Angled sideways

- OM 34-0502 5 1/2" (140mm)
- OM 34-0504 8 1/2" (216mm)

BRAUN EPISIOTOMY SCISSORS

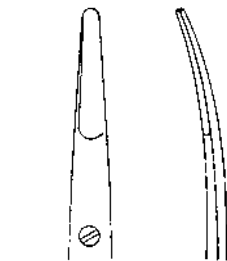
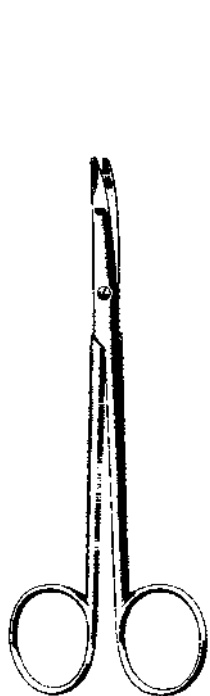

OM 34-0560 OM 34-0562

Curved

- OM 34-0560
- 5" (127mm)
- flat blunt tips

- OM 34-0562
- 7" (178mm)
- flat blunt tips

RAGNELL SCISSORS

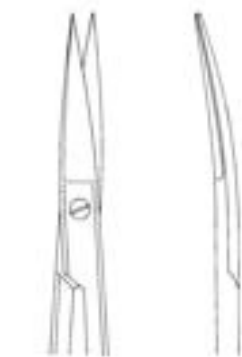

OM 34-0602 OM 34-0607

Straight

- OM 34-0602 smooth sharp/sharp

Curved

- OM 34-0607 smooth sharp/sharp

Angled

- OM 34-0612 smooth sharp/sharp

KELLY FISTULA SCISSORS

6 1/4" (159mm)

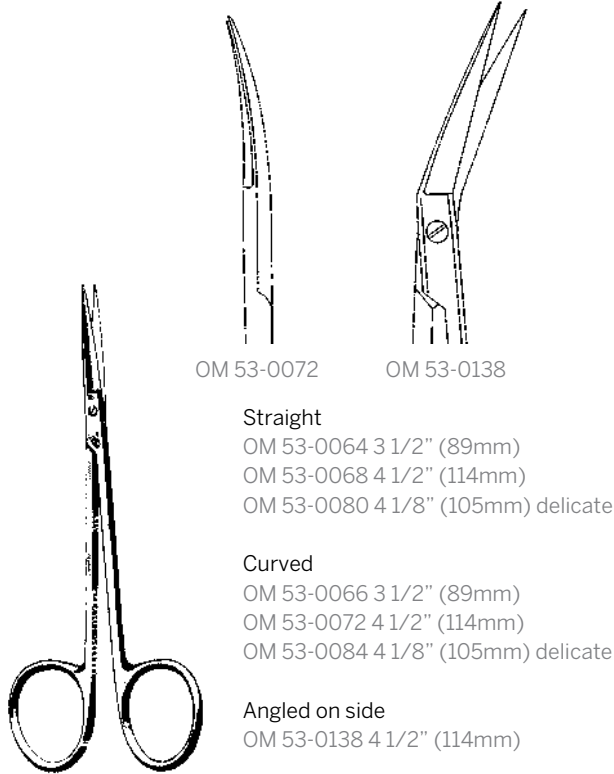

OM 53-0072

OM 53-0138

Straight

- OM 53-0064 3 1/2" (89mm)
- OM 53-0068 4 1/2" (114mm)
- OM 53-0080 4 1/8" (105mm) delicate

Curved

- OM 53-0066 3 1/2" (89mm)
- OM 53-0072 4 1/2" (114mm)
- OM 53-0084 4 1/8" (105mm) delicate

Angled on side

- OM 53-0138 4 1/2" (114mm)

IRIS SCISSORS

Sharp points

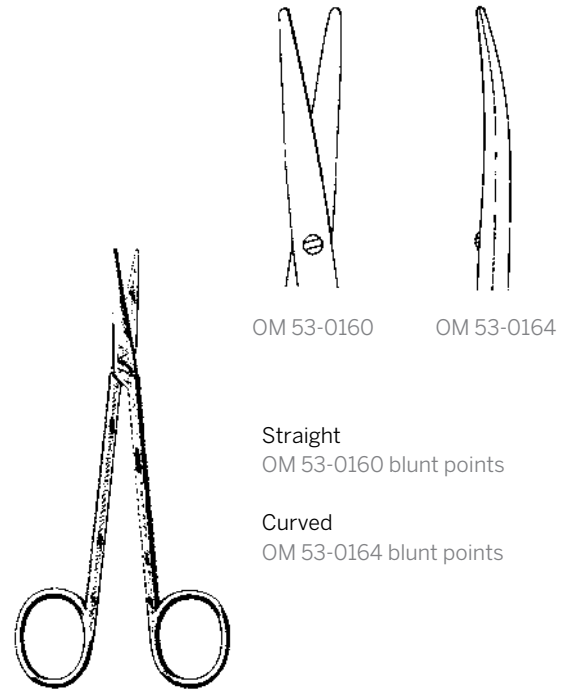

OM 53-0160

OM 53-0164

Straight

- OM 53-0160 blunt points

Curved

- OM 53-0164 blunt points

STRABISMUS SCISSORS

4" (102mm)

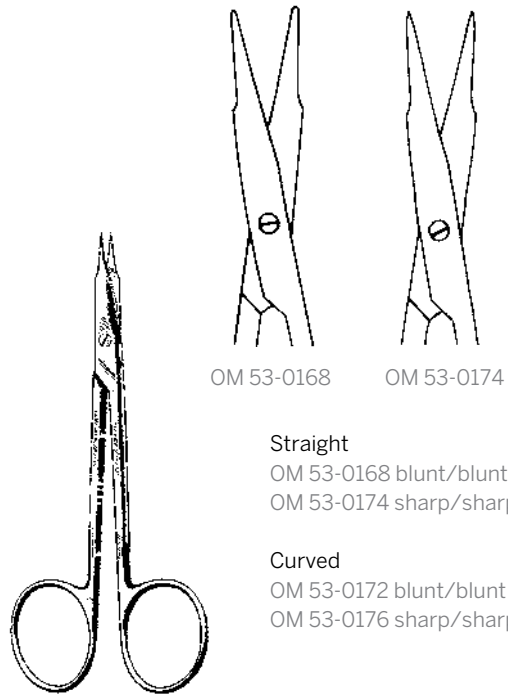

OM 53-0168

OM 53-0174

Straight

- OM 53-0168 blunt/blunt
- OM 53-0174 sharp/sharp

Curved

- OM 53-0172 blunt/blunt
- OM 53-0176 sharp/sharp

STEVENS TENOTOMY SCISSORS

4 1/4" (108mm)



Straight

- OM 53-0265 3 3/4" (95mm)

Curved

- OM 53-0267 4" (102mm)

IRIS SCISSORS RIBBON TYPE

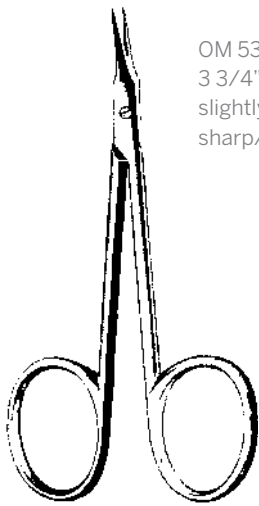

OM 53-0316
3 3/4" (95mm)
slightly curved
sharp/sharp

GRADLE SCISSORS



OM 53-0318
4" (102mm)
slightly curved
ribbon type
sharp/sharp

GRADLE SCISSORS

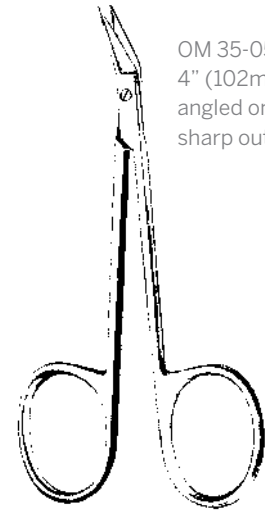

OM 35-0515
4" (102mm)
angled on flat
sharp outside edges

**BIRO DERMAL
NAEVUS SCISSORS**



OM 35-0078
4 5/8" (117.5mm)
with suture hole

OM 35-0078SC
4 5/8" (117.5mm)
with suture hole
super cut

LITTLER SCISSORS



OM 69-0106
3 1/2" (89mm)
curved stainless

NAIL SCISSORS

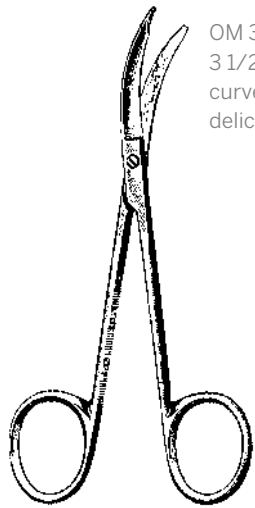

OM 35-0080
3 1/2" (89mm)
curved on side
delicate

**SHORTBENT STITCH
SCISSORS**



Straight
OM 35-0068
3 1/2" (89mm)
delicate

**SPENCER STITCH
SCISSORS**

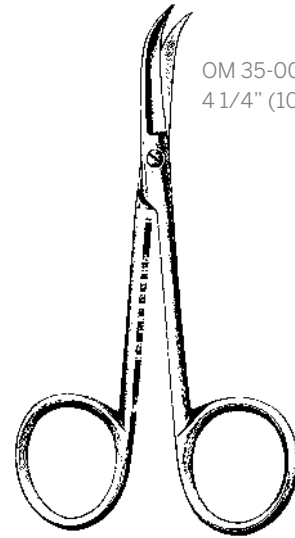

OM 35-0084
4 1/4" (108mm)

**HILL STITCH
SCISSORS**



OM 35-0104
4 3/4"
(121mm)
curved on side

NORTHBENT STITCH SCISSORS

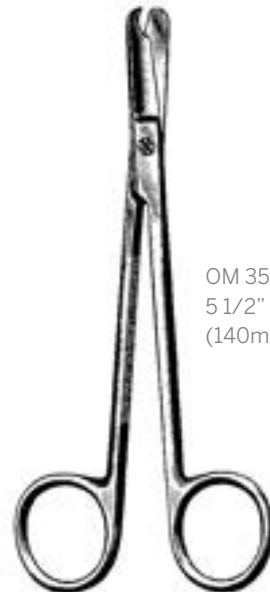

OM 35-0120
5 1/2"
(140mm)

LITTAUER STITCH SCISSORS

Note: Tungsten carbide (TC) is one of the hardest alloys made today. Our TC scissors have tungsten carbide firmly bonded to both cutting edges. We guarantee that they will stay sharp for at least three years. The finger rings are gold plated for easy identification.

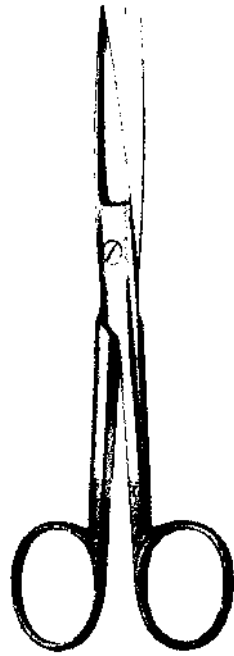

TC OPERATING SCISSORS

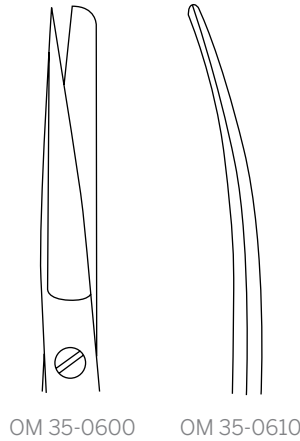

Straight
OM 35-0600
5 1/2" (140mm)
sharp/blunt

Curved
OM 35-0610
5 1/2" (140mm)
sharp/blunt



TC MAYO SCISSORS
Beveled blades

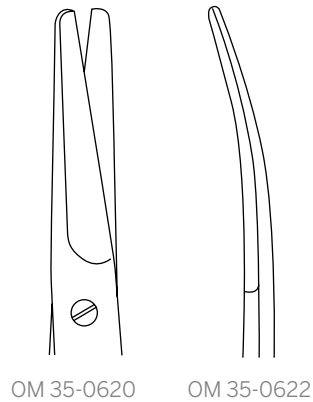

Straight
OM 35-0620 5 1/2" (140mm)
OM 35-0624 6 3/4" (171mm)
OM 35-0628 9" (229mm)

Curved
OM 35-0622 5 1/2" (140mm)
OM 35-0626 6 3/4" (171mm)
OM 35-0630 9" (229mm)



TC METZENBAUM SCISSORS
Blunt points



Straight
OM 35-0640 6" (152mm)
OM 35-0644 7" (178mm)
OM 35-0652 9" (229mm)

Curved
OM 35-0642 6" (152mm)
OM 35-0646 7" (178mm)
OM 35-0654 9" (229mm)

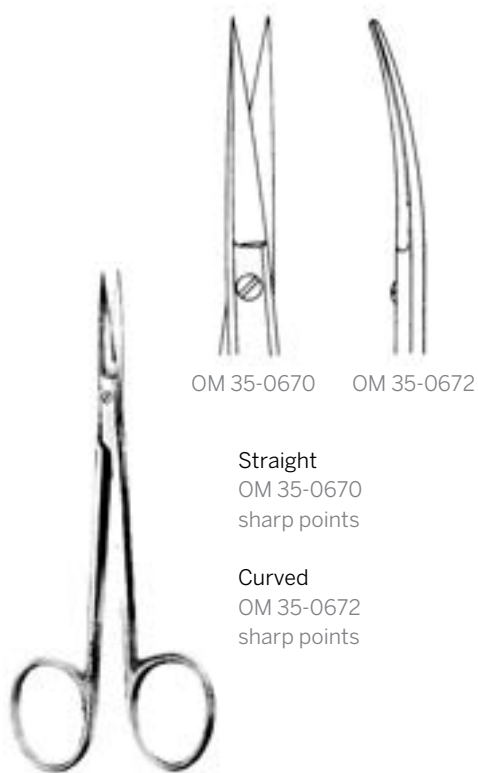

OM 35-0670 OM 35-0672

Straight
OM 35-0670
sharp points

Curved
OM 35-0672
sharp points

TC IRIS SCISSORS
4 1/2" (114mm)

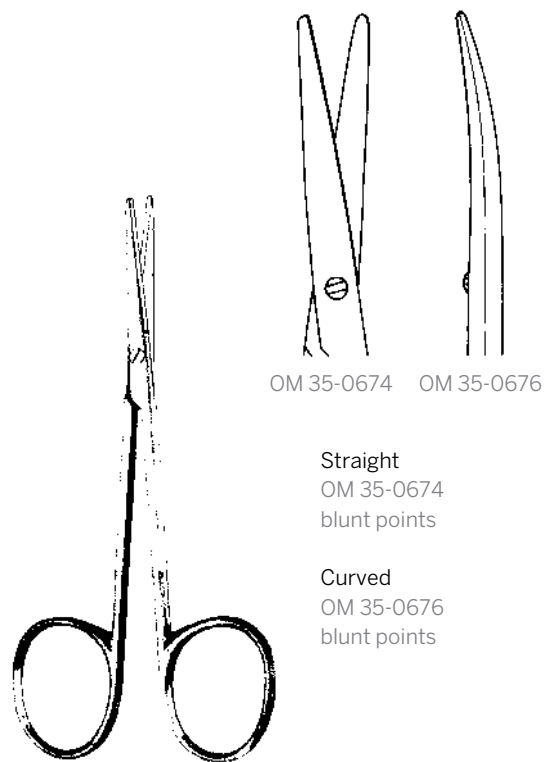

OM 35-0674 OM 35-0676

Straight
OM 35-0674
blunt points

Curved
OM 35-0676
blunt points

TC STRABISMUS SCISSORS
4 1/2" (114mm)

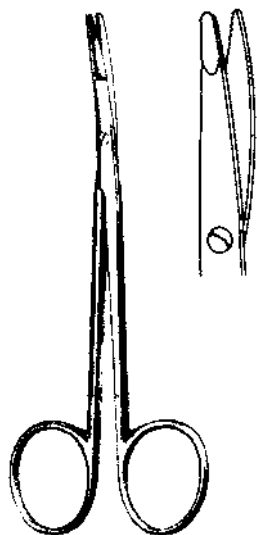

Curved
OM 35-0510
4 1/2" (114mm)
flat tips,
one serrated and
one carbide blade

BLEPHAROPLASTY SCISSORS

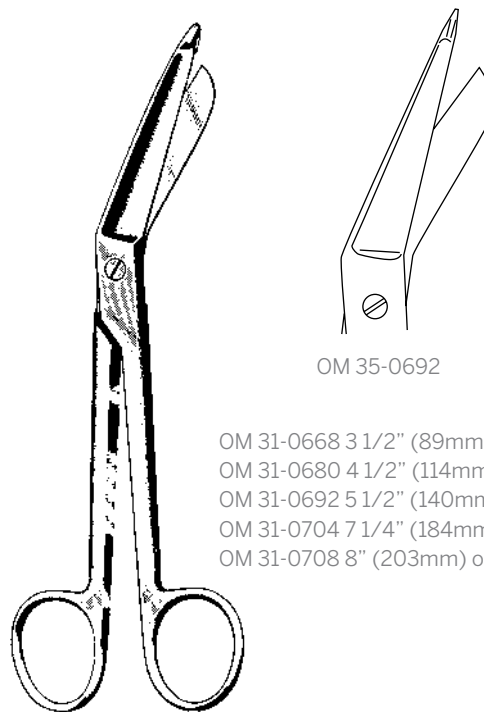

OM 35-0692

OM 31-0668 3 1/2" (89mm)
OM 31-0680 4 1/2" (114mm)
OM 31-0692 5 1/2" (140mm)
OM 31-0704 7 1/4" (184mm)
OM 31-0708 8" (203mm) one large finger ring

LISTER BANDAGE SCISSORS

The delicate offset shanks provide better leverage. The fine knob slides easily under finger and toe bandages.

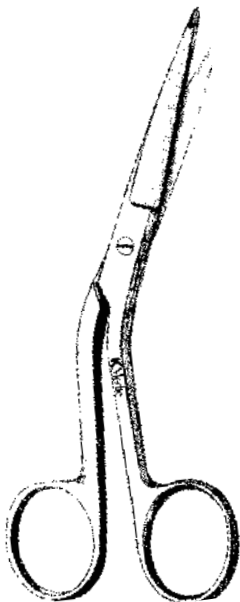

OM 31-0792
5 1/2" (140mm)
shanks angled on side
one serrated blade

HI-LEVEL BANDAGE SCISSORS

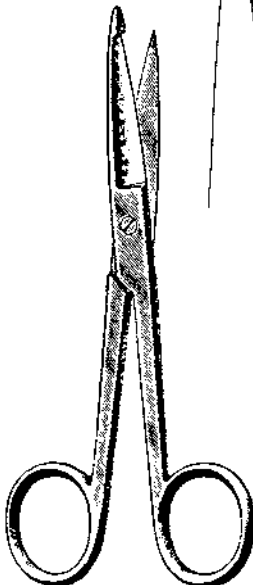

Straight
OM 31-0804
5 1/2" (140mm)
one serrated blade

KNOWLES BANDAGE SCISSORS



For finger and toe bandages.

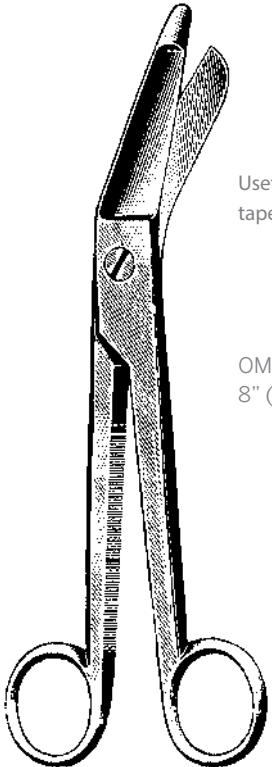

Useful for cutting tape and bandages.

OM 46-0060
8" (203mm)

ESMARCH SHEARS

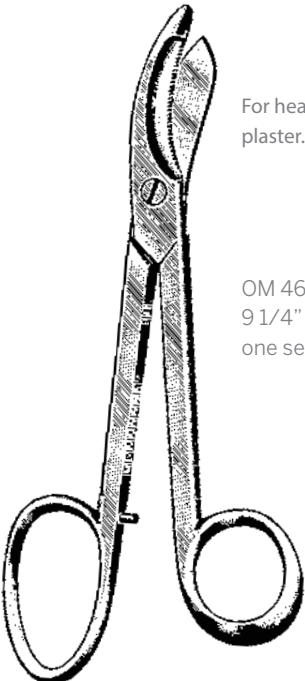

For heavier plaster.

OM 46-0090
9 1/4" (235mm)
one serrated blade

BRUNS SHEARS

For light plaster and cloth.

With autoclavable plastic finger rings.

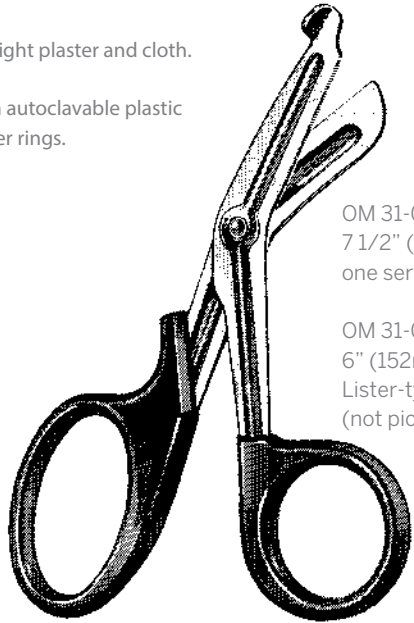

OM 31-0830
7 1/2" (191mm)
one serrated blade

OM 31-0832
6" (152mm)
Lister-type
(not pictured)

UTILITY SCISSORS

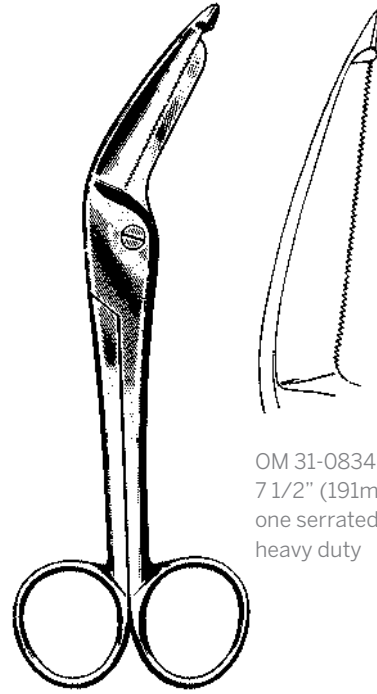

OM 31-0834
7 1/2" (191mm)
one serrated blade
heavy duty

HERCULES SCISSORS



Effective for cloth or cotton wadding.

OM 31-0836
8" (203mm)
with wire cutting notch
one serrated blade

ORTHOMED UTILITY SHEARS



OM MX 5-700
Pink handle

OM MX 5-702
Blue handle

NURSES SCISSORS
5 1/2" (140mm)

Notch for cutting cerclage wire up to 1mm.

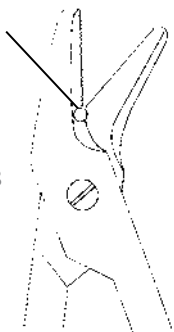

OM 35-0198

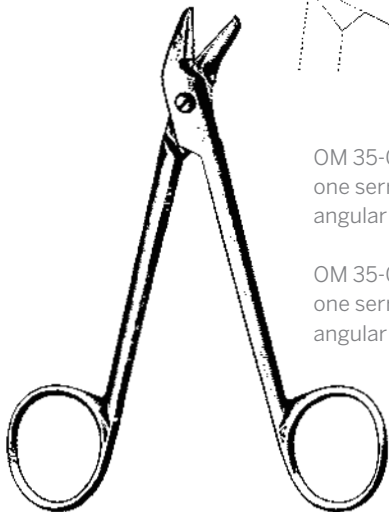

OM 35-0198
one serrated blade
angular

OM 35-0200
one serrated blade
angular carbide

WIRE CUTTING SCISSORS

4 3/4" (121mm)



OM 35-0194

Straight
OM 35-0168
smooth

OM 35-0170
one serrated blade

Curved
OM 35-0192
smooth

OM 35-0194
one serrated blade

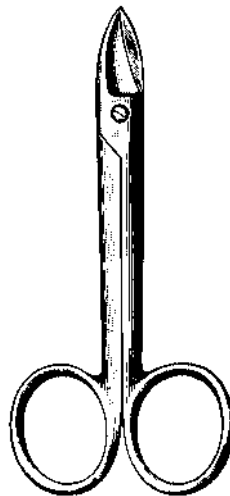

WIRE CUTTING SCISSORS

4" (102mm)



OM 36-0063

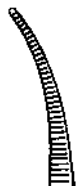

OM 36-0067

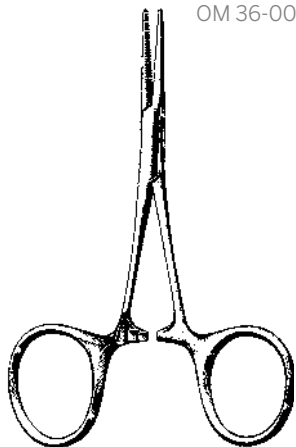

Straight
OM 36-0063

Curved
OM 36-0067

HARTMANN MOSQUITO FORCEPS

3 1/2" (89mm)



OM 36-0164



OM 36-0165



Straight
OM 36-0164

Curved
OM 36-0165

MICRO MOSQUITO FORCEPS

5" (127mm) Extremely fine tips

HEMOSTATIC FORCEPS

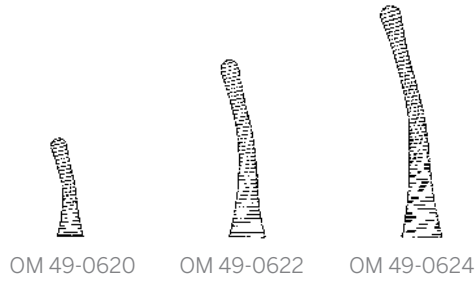

OM 49-0620 OM 49-0622 OM 49-0624

Straight
 OM 49-0602 1 1/2" (38mm)
 OM 49-0604 2" (51mm)
 OM 49-0606 2 1/2" (64mm)
 OM 49-0608 3" (76mm)
 OM 49-0610 3 1/2" (89mm)

Curved
 OM 49-0618 1 1/2" (38mm)
 OM 49-0620 2" (51mm)
 OM 49-0622 2 1/2" (64mm)
 OM 49-0624 3" (76mm)
 OM 49-0626 3 1/2" (89mm)



JOHNS HOPKINS BULLDOG CLAMPS

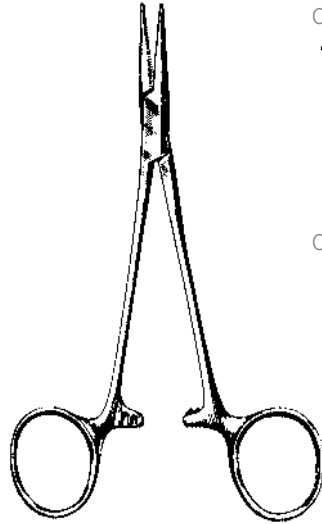

HALSTED MOSQUITO FORCEPS

5" (127mm)

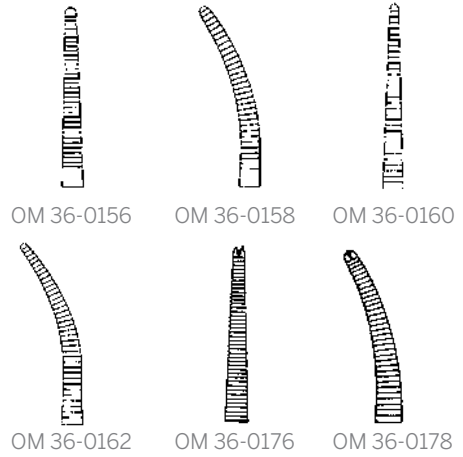

OM 36-0156 OM 36-0158 OM 36-0160

OM 36-0162 OM 36-0176 OM 36-0178

Straight
 OM 36-0156
 OM 36-0160 delicate
 OM 36-0076 1x2 teeth

Curved
 OM 36-0158
 OM 36-0162 delicate
 OM 36-0078 1x2 teeth

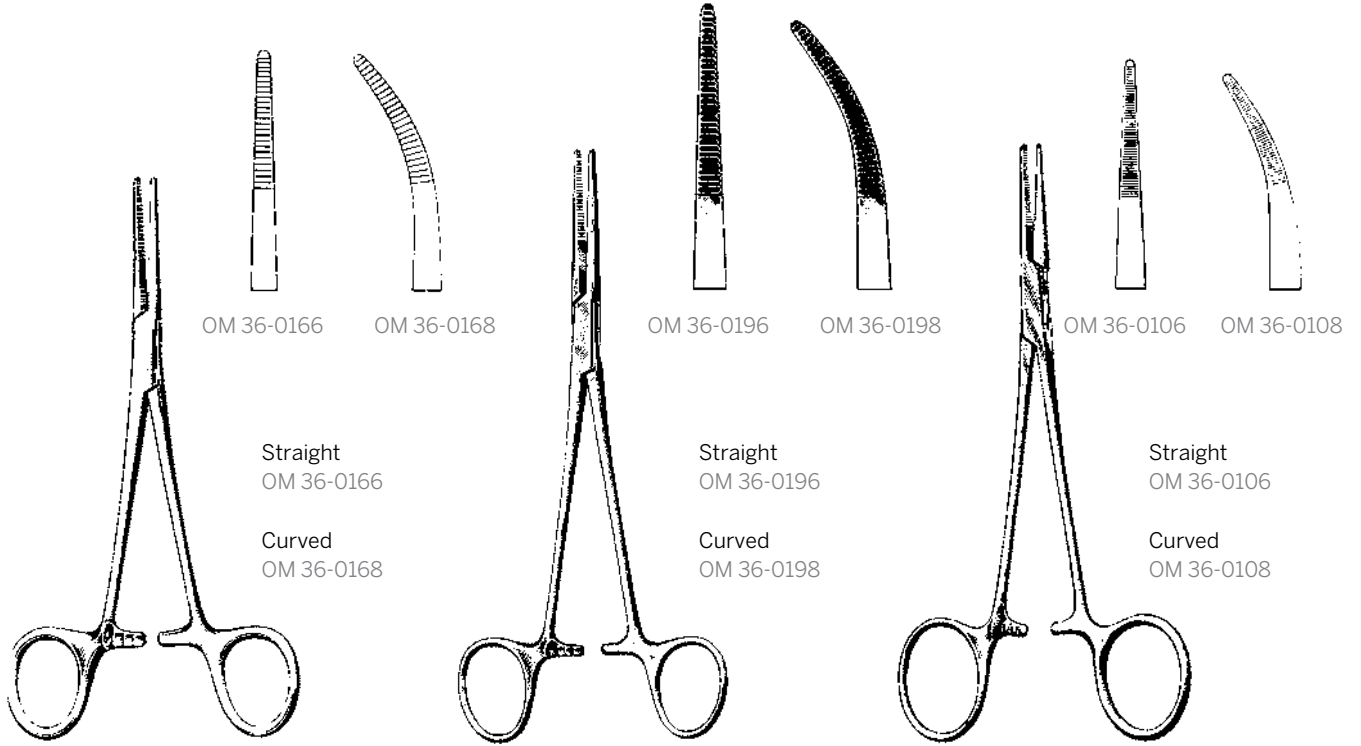

OM 36-0166 OM 36-0168

OM 36-0196 OM 36-0198

OM 36-0106 OM 36-0108

Straight
 OM 36-0166

Curved
 OM 36-0168

Straight
 OM 36-0196

Curved
 OM 36-0198

Straight
 OM 36-0106

Curved
 OM 36-0108

KELLY FORCEPS

5 1/2" (140mm)

RANKIN-KELLY FORCEPS

6 1/4" (159mm)

PROVIDENCE HOSPITAL FORCEPS

5 1/2" (140mm)

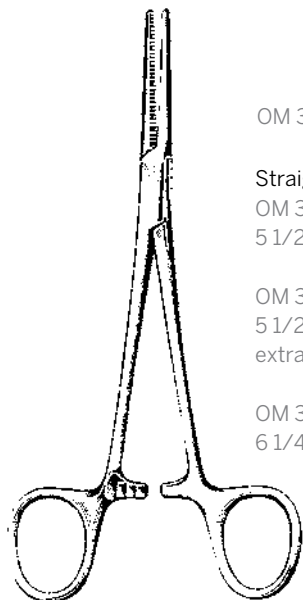

CRILE FORCEPS



OM 36-0176
Straight
OM 36-0176
5 1/2" (140mm)

OM 36-0180
5 1/2" (140mm)
extra delicate

OM 36-0186
6 1/4" (159mm)



OM 36-0178
Curved
OM 36-0178
5 1/2" (140mm)

OM 36-0182
5 1/2" (140mm)
extra delicate

OM 36-0188
6 1/4" (159mm)

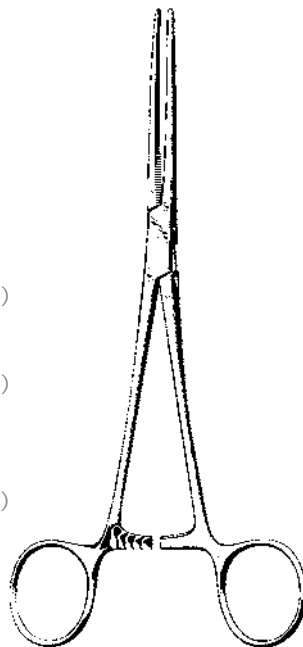

ROCHESTER PEAN FORCEPS



OM 36-0306 OM 36-0308
Straight
OM 36-0306 5 1/2" (140mm)
OM 36-0316 6 1/4" (159mm)
OM 36-0326 7 1/4" (184mm)
OM 36-0336 8" (203mm)
OM 36-0346 9" (229mm)
OM 36-0356 10" (254mm)
OM 36-0360 12" (305mm)

Curved
OM 36-0308 1/2" (140mm)
OM 36-0318 6 1/4" (159mm)
OM 36-0328 7 1/4" (184mm)
OM 36-0338 8" (203mm)
OM 36-0348 9" (229mm)
OM 36-0358 10" (254mm)
OM 36-0362 12" (305mm)

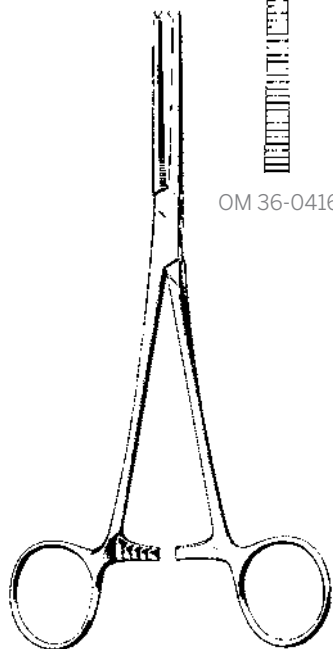

ROCHESTER-OSHSNER FORCEPS
1 x 2 Teeth



OM 36-0416 OM 36-0418



Straight Curved
OM 36-0406 OM 36-0408
5 1/2" (140mm) 5 1/2" (140mm)

OM 36-0416 OM 36-0418
6 1/4" (159mm) 6 1/4" (159mm)

OM 36-0426 OM 36-0428
7 1/4" (184mm) 7 1/4" (184mm)

OM 36-0436 OM 36-0438
8" (203mm) 8" (203mm)

OM 36-0446 OM 36-0448
9" (229mm) 9" (229mm)

OM 36-0456 OM 36-0458
10" (254mm) 10" (254mm)

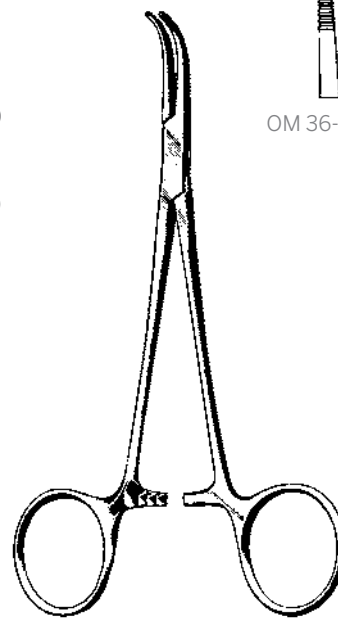

MIXTER FORCEPS
Fully curved



OM 36-0557

OM 36-0566
OM 36-0557
5 1/4" (133mm)
delicate

OM 36-0562
6 1/4" (159mm)

OM 36-0564
7 1/4" (184mm)

OM 36-0566
9" (229mm)



OM 36-0570
7" (171mm)
serrated

GEMINI MIXTER FORCEPS

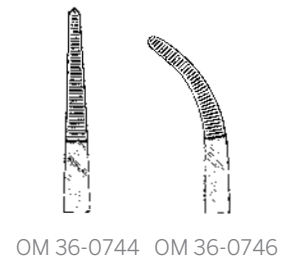
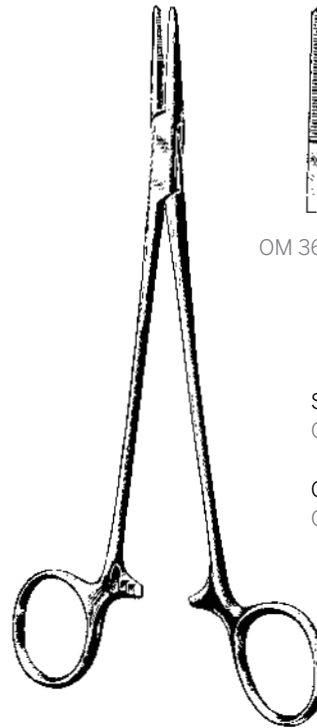

Straight
OM 36-0744

Curved
OM 36-0746

ADSON HEMOSTATIC FORCEPS
7 1/4" (184mm)



OM 36-0518
Straight
OM 36-0516
6 1/4" (159mm)

OM 36-0536
8" (203mm)

Curved
OM 36-0518
6 1/4" (159mm)

OM 36-0538
8" (203mm)

ROCHESTER-CARMALT FORCEPS



OM 36-0818
Straight
OM 36-0816
6 1/2" (165mm)

OM 36-0826
7 1/2" (191mm)

Curved
OM 36-0818
6 1/2" (165mm)

OM 36-0828
7 1/2" (191mm)

FERGUSON ANGIOTRIBE FORCEPS

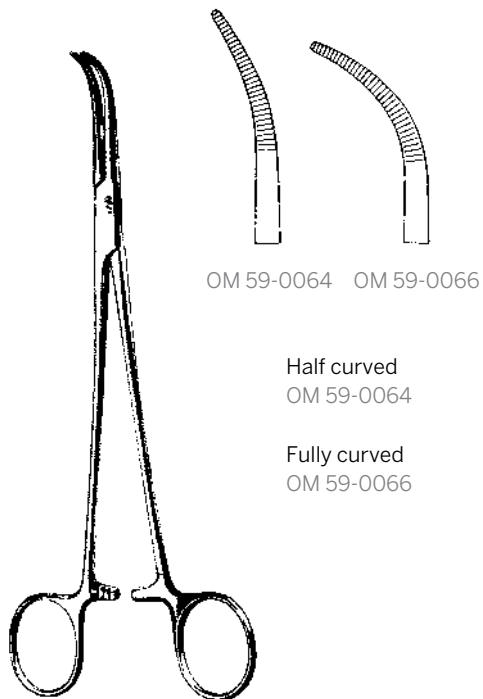

OM 59-0064 OM 59-0066

Half curved
OM 59-0064

Fully curved
OM 59-0066

SCHNIDT FORCEPS

7 1/2" (191mm)

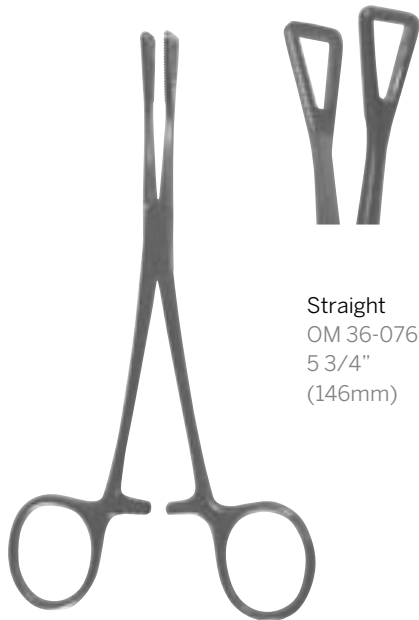

Straight
OM 36-0766
5 3/4"
(146mm)

PENNINGTON FORCEPS

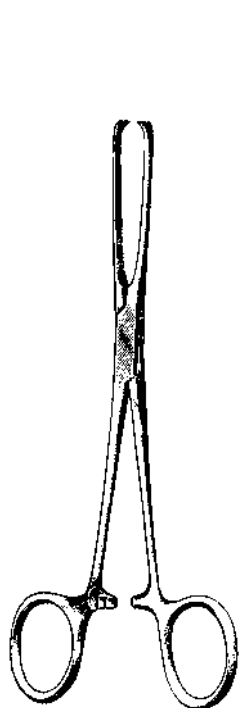

OM 43-0105

OM 43-0105 4 3/4" (121mm)
4x5 teeth delicate

OM 43-0107 5 3/4" (146mm)
4x5 teeth delicate

OM 43-0110 6" (152mm)
3x4 teeth standard

OM 43-0112 6" (152mm)
4x5 teeth standard

OM 43-0116 6" (152mm)
5x6 teeth standard

OM 49-0628 10"
5x6 teeth standard

OM 49-0629 12"
5x6 teeth standard

ALLIS TISSUE FORCEPS



OM 43-0124
7 1/2" (191mm)
5x6 teeth

ALLIS TISSUE FORCEPS

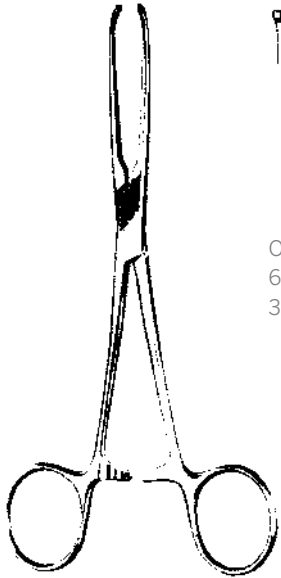

OM 43-0168
6" (152mm)
3x4 teeth

ALLIS-JUDD TISSUE FORCEPS

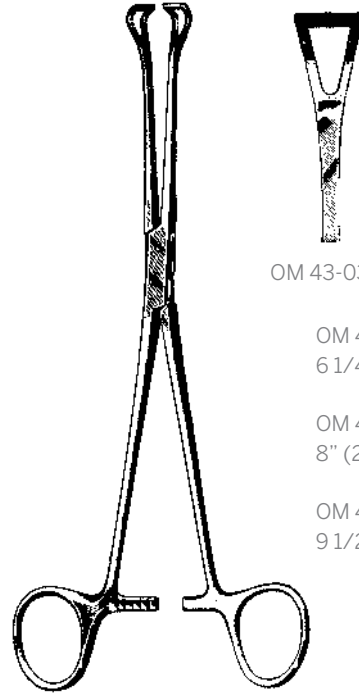

OM 43-0310

OM 43-0310
6 1/4" (159mm)

OM 43-0324
8" (203mm)

OM 43-0326
9 1/2" (241mm)

BABCOCK FORCEPS



OM 36-0696
6 1/4" (159mm)
3x3 prongs

LAHEY VULSELLUM FORCEPS

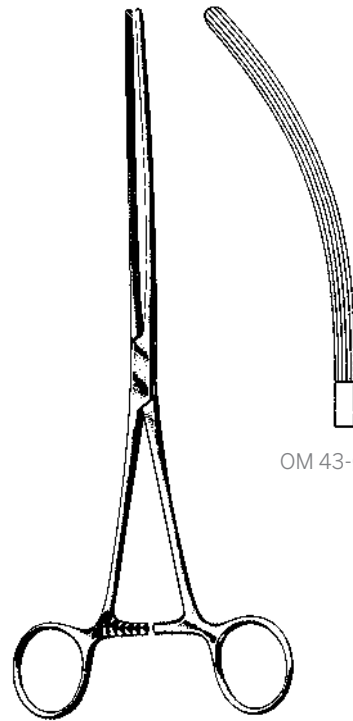

OM 43-0524

Straight
OM 43-0520

Curved
OM 43-0524

DOYEN CLAMP
9" (229mm) Longitudinal serrations

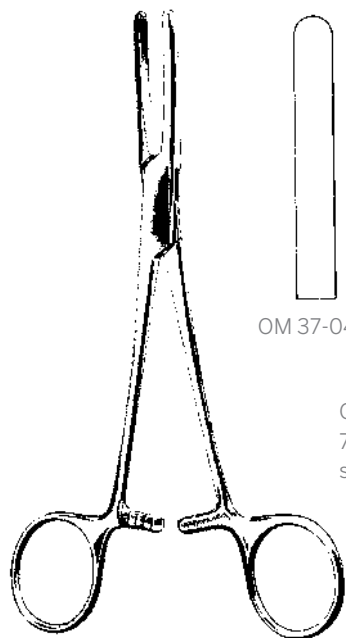

OM 37-0444

OM 37-0444
7" (178mm)
smooth

**PRESBYTERIAN TUBE
OCCLUDING FORCEPS**

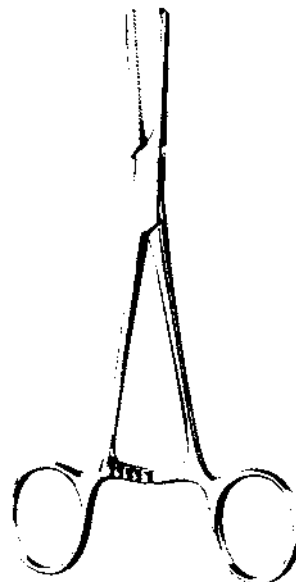

OM 37-0448

OM 37-0448
5 1/2" (140mm)

OM 37-0450
7 1/4" (184mm)

OM 37-0452
8" (203mm)

VORSE TUBE OCCLUDING FORCEPS
Serrated

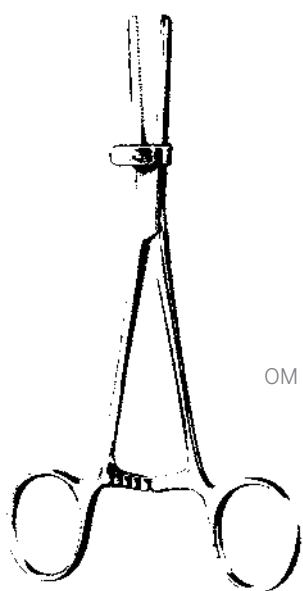

OM 37-0453

OM 37-0453 5 1/2" (140mm)
OM 37-0454 7 1/4" (184mm)
OM 37-0455 8" (203mm)

VORSE TUBE OCCLUDING FORCEPS
Serrated, with guard

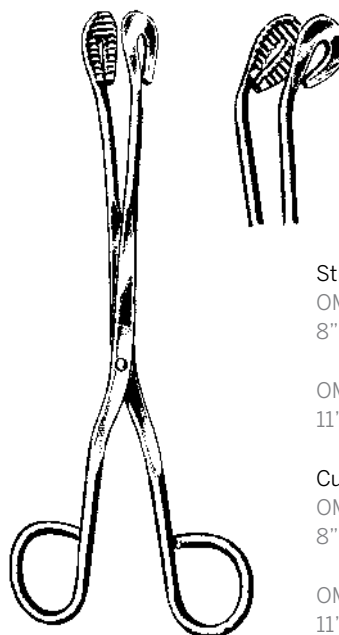

Straight
OM 39-0644
8" (203mm)

OM 39-0646
11" (279mm)

Curved
OM 39-0648
8" (203mm)

OM 39-0650
11" (279mm)

**UTILITY AND
STERILIZER FORCEPS**

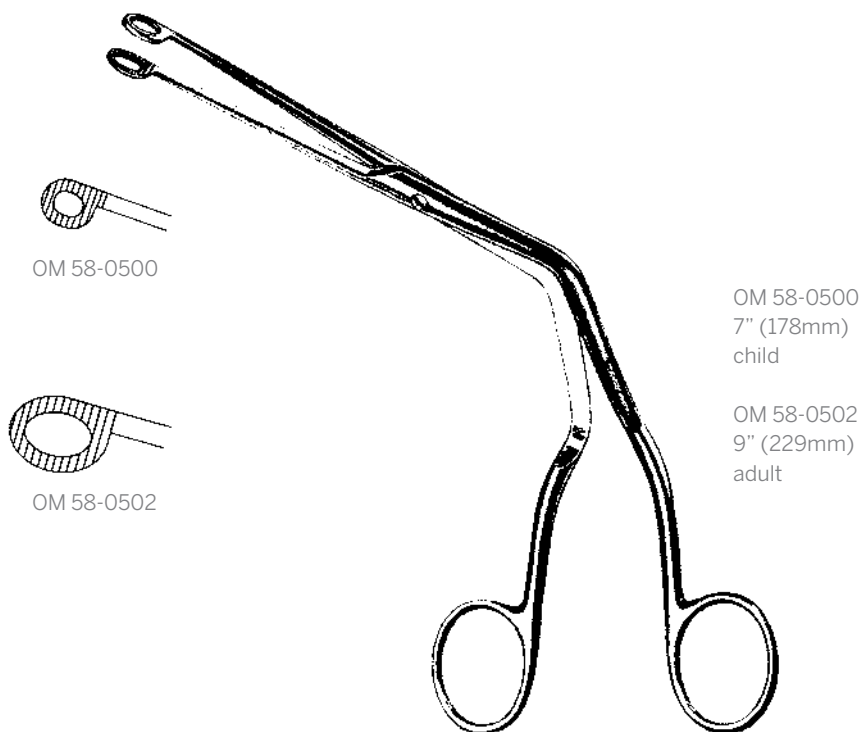

OM 58-0500

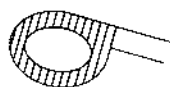

OM 58-0502

OM 58-0500
7" (178mm)
child

OM 58-0502
9" (229mm)
adult

MAGILL ENDOTRACHEAL CATHETER INTRODUCING FORCEPS



OM 37-0470
2 1/2" (64mm)

OM 37-0478
3 1/4" (83mm)

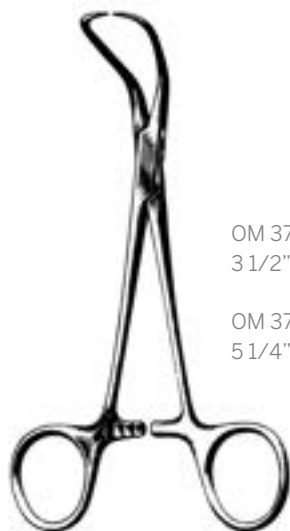

OM 37-0458
3 1/2" (89mm)

OM 37-0462
5 1/4" (133mm)

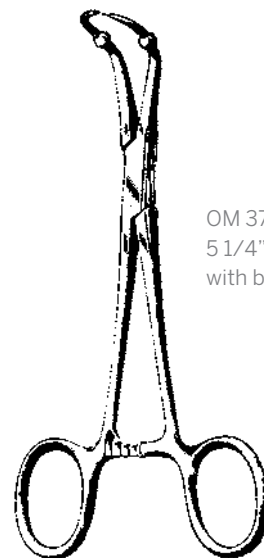

OM 37-0464
5 1/4" (133mm)
with ball stops

JONES TOWEL FORCEPS

BACKHAUS TOWEL FORCEPS

BACKHAUS-ROEDER TOWEL CLAMP

TOWEL AND SPONGE FORCEPS/DRESSING AND TISSUE FORCEPS



OM 47-0466

OM 37-0466
4" (102mm)
non-perforating

OM 37-0468
5 1/4" (133mm)
non-perforating

**LORNA (EDNA)
TOWEL CLAMP**

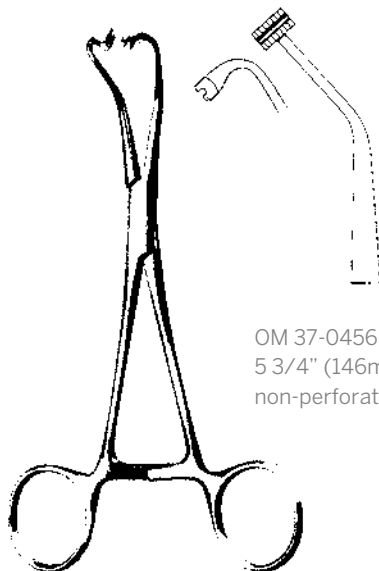

OM 37-0456
5 3/4" (146mm)
non-perforating

PEERS TOWEL CLAMP

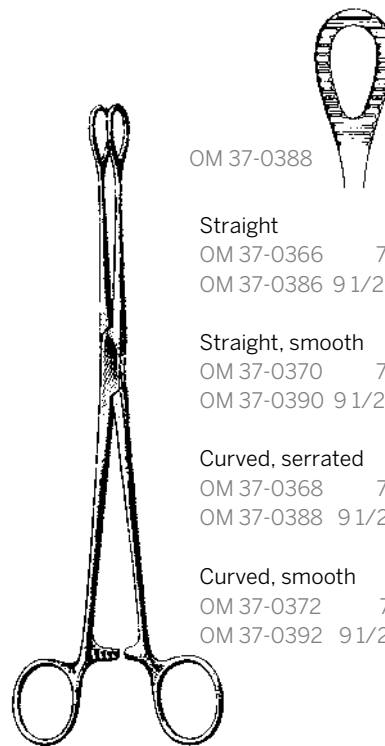

OM 37-0388

Straight
OM 37-0366 7" (178mm)
OM 37-0386 9 1/2" (241mm)

Straight, smooth
OM 37-0370 7" (178mm)
OM 37-0390 9 1/2" (241mm)

Curved, serrated
OM 37-0368 7" (178mm)
OM 37-0388 9 1/2" (241mm)

Curved, smooth
OM 37-0372 7" (178mm)
OM 37-0392 9 1/2" (241mm)

**FOERSTER SPONGE
FORCEPS**



OM 47-0466

OM 38-0076 4 1/2" (114mm)
OM 38-0080 5" (127mm)
OM 38-0084 5 1/2" (140mm)
OM 38-0088 6" (152mm)
OM 38-0094 8" (203mm)
OM 38-0100 10" (254mm)
OM 38-0106 12" (305mm)

DRESSING FORCEPS
Serrated

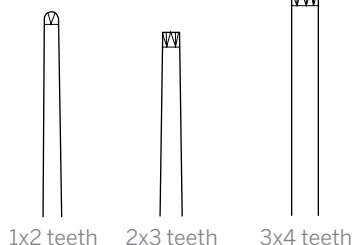

1x2 teeth
OM 38-0264 4 1/2" (114mm)
OM 38-0268 5" (127mm)
OM 38-0272 5 1/2" (140mm)
OM 38-0276 6" (152mm)
OM 38-0280 8" (203mm)
OM 38-0286 10" (254mm)
OM 38-0290 12" (305mm)

2x3 teeth
OM 38-0292 5" (127mm)
OM 38-0296 5 1/2" (140mm)

3x4 teeth
OM 38-0304 5 1/2" (140mm)

TISSUE FORCEPS

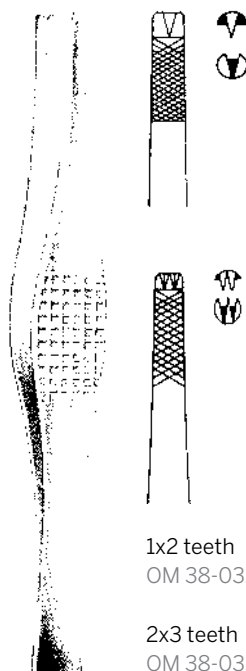

1x2 teeth
OM 38-0322

2x3 teeth
OM 38-0324

FERRIS-SMITH TISSUE FORCEPS
7" (178mm) with platform

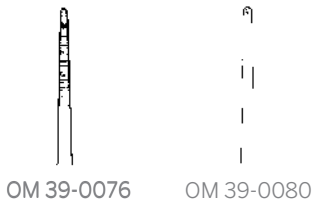

OM 39-0076 OM 39-0080

Serrated
 OM 39-0076 5" (127mm)
 OM 39-0086 6" (152mm)

1x2 teeth
 OM 39-0080 5" (127mm)
 OM 39-0088 6" (152mm)

SEMKEN FORCEPS

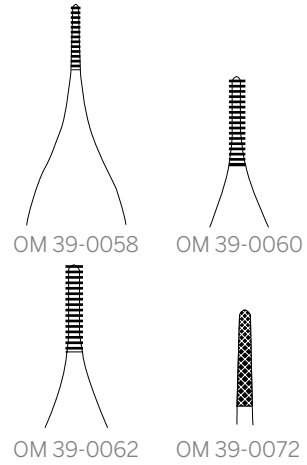

OM 39-0058 micro tip
 OM 39-0060 delicate tip
 OM 39-0062 standard tip
 OM 39-0072 carbide tip

ADSON DRESSING FORCEPS

4 3/4" (121mm) serrated

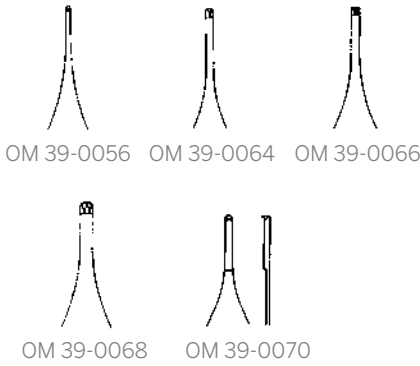
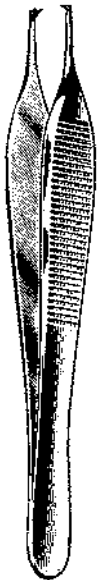

OM 39-0056 OM 39-0064 OM 39-0066

OM 39-0068 OM 39-0070

1x2 teeth
 OM 39-0056 micro tip
 OM 39-0063 serrated tip
 OM 39-0064 delicate tip
 OM 39-0066 standard tip
 OM 39-0070 delicate, with tying platform
 OM 39-0071 carbide tip

2x3 teeth
 OM 39-0068

ADSON TISSUE FORCEPS

4 3/4" (121mm)

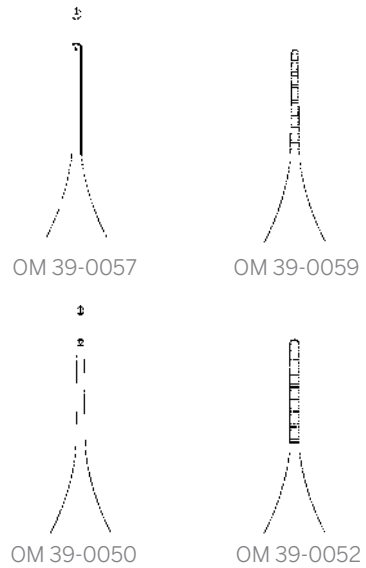

OM 39-0057 micro 1x2 teeth
 OM 39-0059 micro serrated
 OM 39-0050 1x2 teeth
 OM 39-0052 serrated

ADSON DRESSING AND TISSUE FORCEPS

6" (152mm)

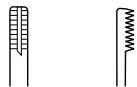

OM 39-0092
4 3/4" (121mm)
9x9 teeth
side grasping

ADSON BROWN TISSUE FORCEPS



OM 39-0098
7" (178mm) 3mm
2x3 teeth

OM 39-0099
7" (178mm) 3mm
2x3 teeth
with carbide inserts

ADSON TISSUE FORCEPS



OM 39-0055

ADSON TISSUE FORCEP
TC 1S2 Teeth SERR. 6"



OM 39-0136

OM 39-0128 4 1/2" (114mm)
OM 39-0132 5" (127mm)
OM 39-0136 5 1/2" (140mm)
OM 39-0140 6" (152mm)

DRESSING FORCEPS
Serrated with fluted handles



OM 39-0310 4 1/2" (114mm)
OM 39-0314 5" (127mm)
OM 39-0318 5 1/2" (140mm)
OM 39-0322 6" (152mm)

TISSUE FORCEPS
1x2 teeth with fluted handles

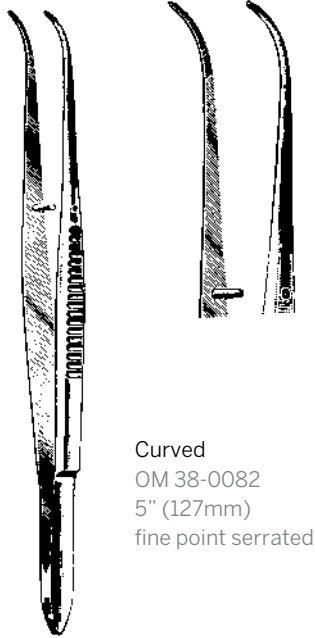

Curved
OM 38-0082
5" (127mm)
fine point serrated

DRESSING FORCEPS



OM 39-0192

OM 39-0192 6" (152mm)
OM 39-0196 8" (203mm)
OM 39-0197 9" (229mm)
OM 39-0198 10" (254mm)

**RUSSIAN
TISSUE FORCEPS**

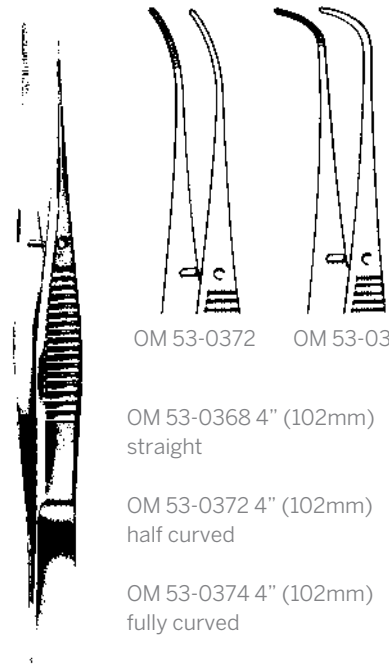

OM 53-0372 OM 53-0374

OM 53-0368 4" (102mm)
straight
OM 53-0372 4" (102mm)
half curved
OM 53-0374 4" (102mm)
fully curved

EYE DRESSING FORCEPS
4" (102mm) serrated



OM 49-0168 OM 49-0170 OM 49-0172

OM 49-0168 6 1/4" (159mm) 1.5mm
OM 49-0170 8" (203mm) 1.5mm
OM 49-0172 9 1/4" (235mm) 1.5mm
OM 49-0180 6 1/4" (159mm) 2.0mm
OM 49-0182 8" (203mm) 2.0mm
OM 49-0184 9 1/4" (235mm) 2.0mm
OM 49-0210 6 1/4" (159mm) 3.5mm
OM 49-0212 8" (203mm) 3.5mm
OM 49-0216 9 1/4" (235mm) 3.5mm

**DEBAKEY ATRAUMATIC
TISSUE FORCEPS**

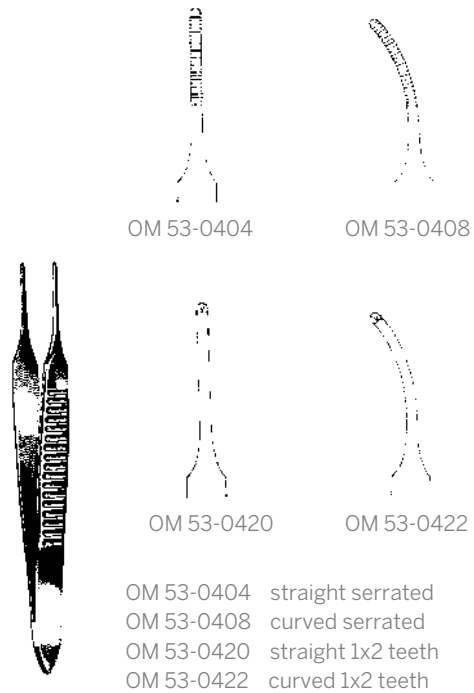

OM 53-0404 OM 53-0408

OM 53-0420 OM 53-0422

OM 53-0404 straight serrated
OM 53-0408 curved serrated
OM 53-0420 straight 1x2 teeth
OM 53-0422 curved 1x2 teeth

GRAEFE EYE DRESSING FORCEPS
2 1/2" (64mm)

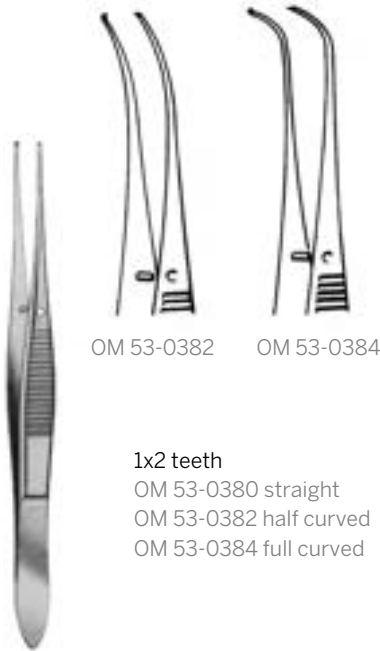

OM 53-0382 OM 53-0384

1x2 teeth
 OM 53-0380 straight
 OM 53-0382 half curved
 OM 53-0384 full curved

IRIS FORCEPS

4" (102mm)



Extra narrow
 OM 38-0166

DRESSING FORCEPS

5 1/2" (140mm)



1x2 teeth delicate
 OM 38-0180 straight
 OM 38-0181 curved
 OM 38-0182 straight TC

GERALD DRESSING FORCEPS

6 3/4" (171mm)

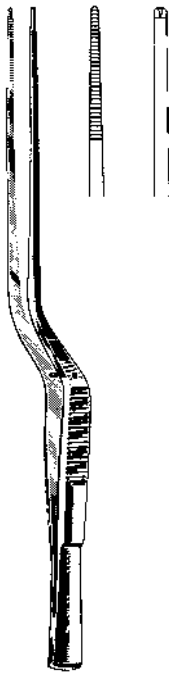

OM 38-0186 1x2 teeth
 OM 38-0184 serrated

CUSHING BAYONET TISSUE FORCEPS

7 1/4" (184mm)

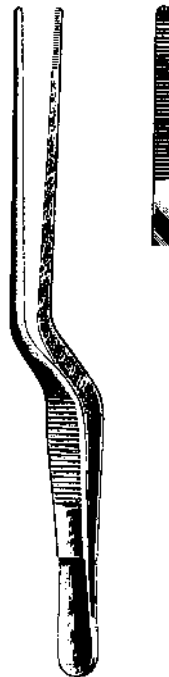

OM 39-0074
 8 1/4" (210mm)
 straight with serrated tips

ADSON BAYONET FORCEPS

8 1/4" (210mm)

JEWELERS FORCEPS/SPLINTER FORCEPS



OM 39-0450
#3
4 3/4" (121mm)
narrow fine



OM 39-0451
#3C
4 3/8" (111mm)
narrow fine



OM 39-0452
#4
4 3/8" (111mm)
fine



OM 39-0453
#5
4 3/8" (111mm)
extra fine



OM 39-0455
#6
4 1/2" (114mm)
angled pickup



OM 39-0456
#7
4 1/2" (114mm)
curved fine

SWISS JEWELERS STYLE FORCEPS

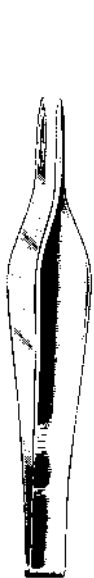

**FEILCHENFELD
FORCEPS**
Serrated



OM 39-0386

OM 39-0386
3 1/4" (83mm)

OM 39-0390
4 1/2" (114mm)

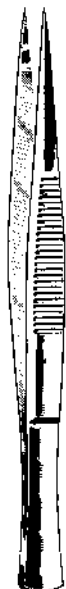

**PLAIN SPLINTER
FORCEPS**
Serrated



OM 39-0366

OM 39-0364
3 1/2" (89mm)

OM 39-0366
4 1/2" (114mm)



**CARMALT SPLINTER
FORCEPS**
4 1/4" (108mm) Serrated



OM 39-0410

Straight
OM 39-0410



OM 39-0412

Curved
OM 39-0412

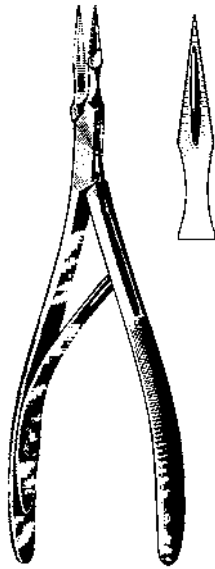

OM 39-0478
6" (152mm)
serrated

VIRTUS SPLINTER FORCEPS



OM 39-0534
5" (127mm)
trocar in reversible handle

OM 39-0536
trocar point only

VANGUARD SPLINTER LIBERATOR

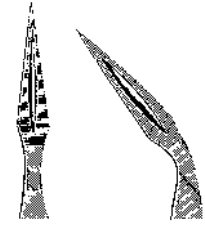

OM 39-0509 OM 39-0511

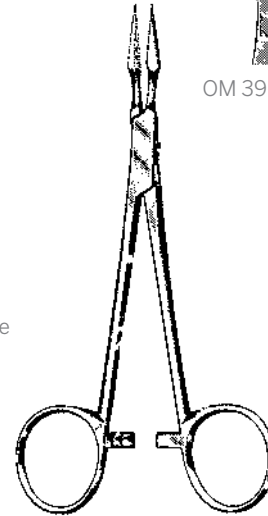

OM 39-0509
5 1/2" (140mm)
straight

OM 39-0511
5 1/4" (133mm)
45 degree angled

OM 39-0513
5 1/2" (140mm)
90 degree angled

WILLIAMS SPLINTER FORCEPS
Serrated

Note: Our carbide needle holders have TC inserts firmly bonded to the inside of both jaws. We guarantee them for three years. The surface profiles of the inserts have been precision milled to provide the surgeon with a firm, non-slip grip on the needle. Because the carbide is harder than the steel needles, carbide needle holders last much longer than ordinary ones. The finger rings are gold plated for easy identification.



OM 41-0064



OM 41-0066

OM 41-0064
smooth

OM 41-0065
smooth carbide

OM 41-0066
serrated

OM 41-0067
serrated carbide

HALSEY NEEDLE HOLDER
5" (127mm) Serrated



OM 41-0164

OM 41-0166

OM 41-0162
5" (127mm)
serrated

OM 41-0164
5 3/4" (146mm)
serrated

OM 41-0166
5 1/2" (140mm)
serrated carbide

HEGAR BAUMGARTNER NEEDLE HOLDER

NEEDLE HOLDER

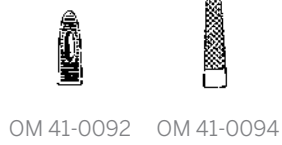
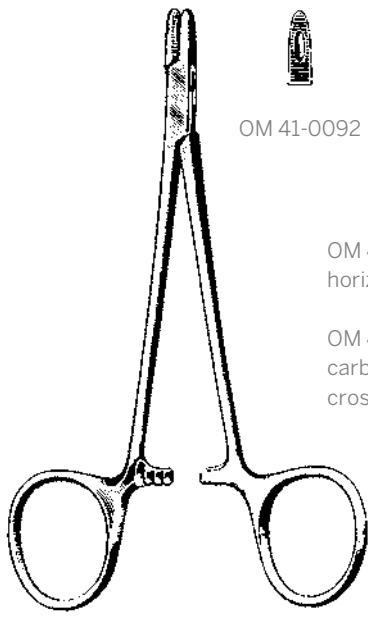

OM 41-0092
horizontal serrations

OM 41-0094
carbide
cross serrations

DERF NEEDLE HOLDER

4 3/4" (121mm)

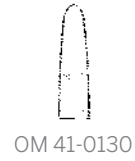
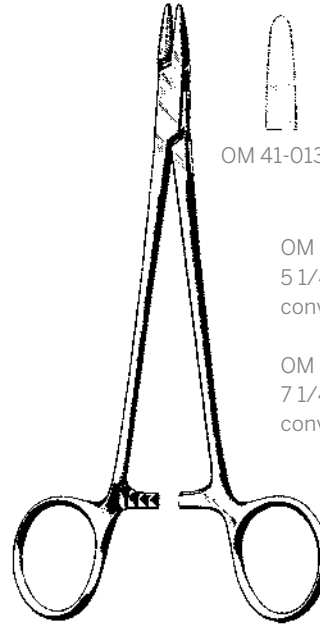

OM 41-0130
5 1/4" (133mm)
convex jaws

OM 41-0132
7 1/4" (184mm)
convex jaws

BROWN NEEDLE HOLDER

Fine serrations

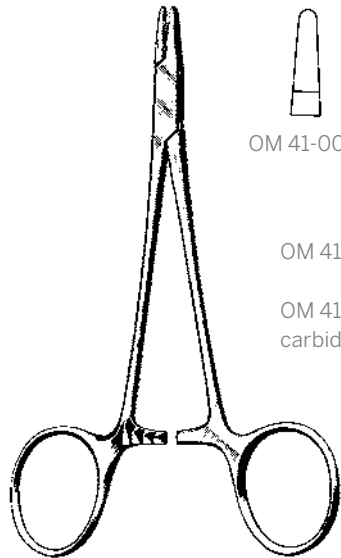

OM 41-0068

OM 41-0070
carbide

**WEBSTER
NEEDLE HOLDER**

5" (127mm) Smooth

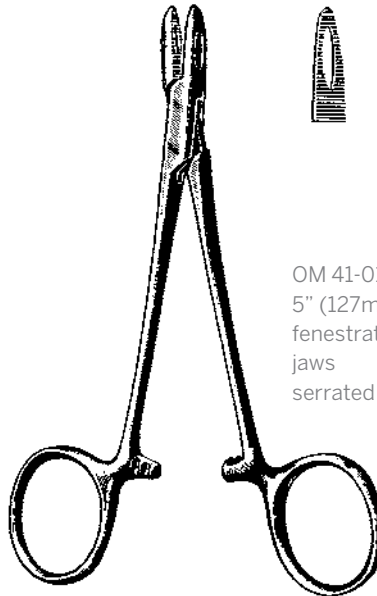

OM 41-0104
5" (127mm)
fenestrated
jaws
serrated

**COLLIER
NEEDLE HOLDER**

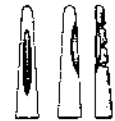
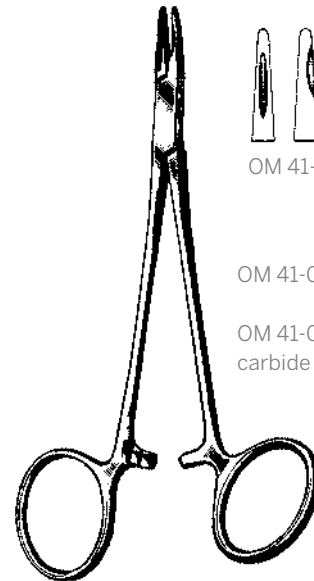

OM 41-0106

OM 41-0106

OM 41-0108
carbide

**NIEVERT
NEEDLE HOLDER**

5" (127mm) Smooth, one offset finger ring

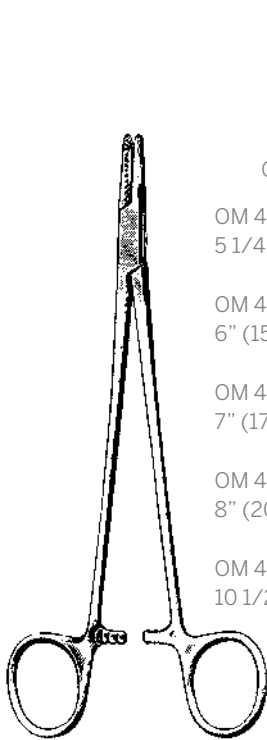

- | | |
|-------------------------------|--|
| OM 41-0270 | OM 41-0302 |
| OM 41-0270
5 1/4" (133mm) | Carbide
OM 41-0300
5" (127mm) |
| OM 41-0272
6" (152mm) | OM 41-0302
6" (152mm) |
| OM 41-0278
7" (178mm) | OM 41-0308
7" (178mm) |
| OM 41-0284
8" (203mm) | OM 41-0314
8" (203mm) |
| OM 41-0286
10 1/2" (267mm) | OM 41-0316
10 1/2" (267mm) |
| | Left hand
OM 41-0302L
6" (152mm) |

MAYO HEGAR NEEDLE HOLDER
Serrated

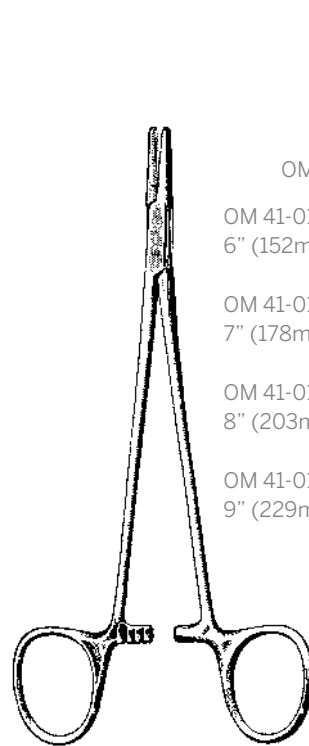

- | | |
|--------------------------|-------------------------------------|
| OM 41-0170 | OM 41-0174 |
| OM 41-0170
6" (152mm) | Carbide
OM 41-0174
6" (152mm) |
| OM 41-0171
7" (178mm) | OM 41-0175
7" (178mm) |
| OM 41-0172
8" (203mm) | OM 41-0176
8" (203mm) |
| OM 41-0173
9" (229mm) | OM 41-0178
9" (229mm) |

CRILE-WOOD (DEBAKEY) NEEDLE HOLDER
Serrated

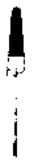
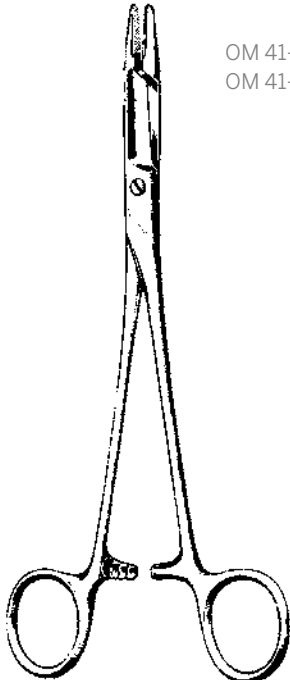

- | | |
|---|------------|
| OM 41-0424 | OM 41-0428 |
| OM 41-0440 | OM 41-0448 |
| OM 41-0424
4 3/4" (121mm) delicate serrated* | |
| OM 41-0426
4 3/4" (121mm) delicate smooth* | |
| OM 41-0428
5 1/2" (140mm) serrated | |
| OM 41-0432
6 1/2" (165mm) serrated | |
| OM 41-0434
7 1/2" (191mm) serrated | |
| Carbide | |
| OM 41-0440
4 3/4" (121mm) delicate serrated* | |
| OM 41-0446
4 3/4" (121mm) delicate smooth* | |
| OM 41-0448
5 1/2" (140mm) serrated | |
| OM 41-0452
6 1/2" (165mm) serrated | |
| OM 41-0454
7 1/2" (191mm) serrated | |
| * For suture sizes 5-0, 6-0, 7-0 only. | |

OLSEN-HEGAR NEEDLE HOLDER
Combination needle holder and suture scissors

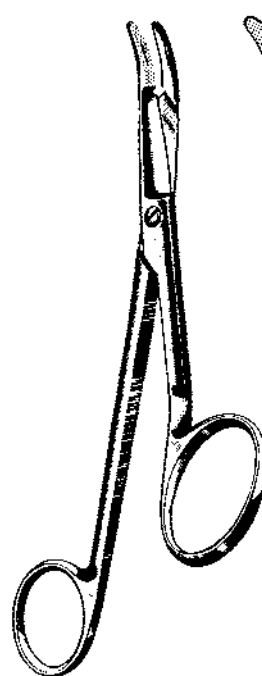

- Curved
OM 41-0333
6 1/2" (165mm)
one fenestrated jaw one angled finger ring

GILLIES NEEDLE HOLDER
Combination needle holder and suture scissors

NEEDLE HOLDER

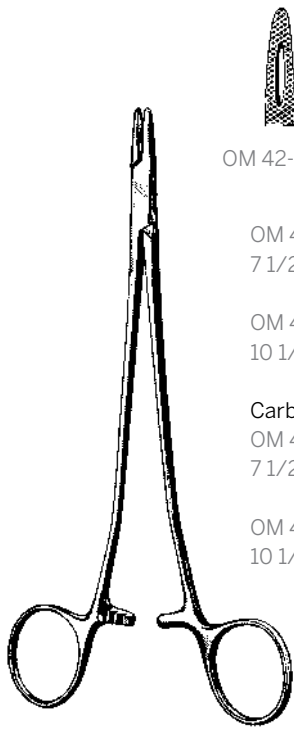

OM 42-0148

OM 42-0148
7 1/2" (191mm)

OM 42-0150
10 1/2" (267mm)

Carbide
OM 42-0152
7 1/2" (191mm)

OM 42-0154
10 1/2" (267mm)

SAROT NEEDLE HOLDER
Serrated

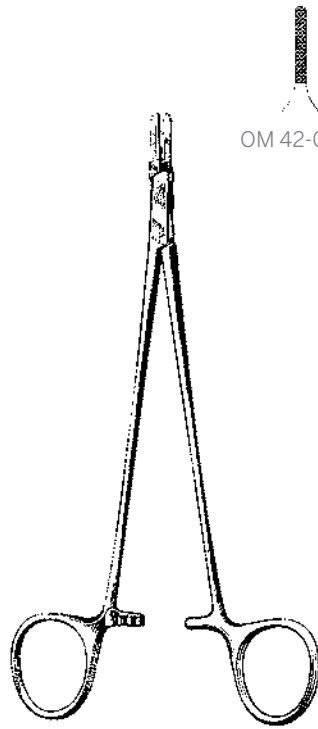

OM 42-0257

OM 41-0257
5" (127mm)

OM 41-0264
6" (152mm)

OM 41-0265
7" (178mm)

OM 41-0266
8" (203mm)

OM 41-0267
9" (229mm)

OM 41-0268
10 1/4" (260mm)

RYDER NEEDLE HOLDER
Serrated carbide

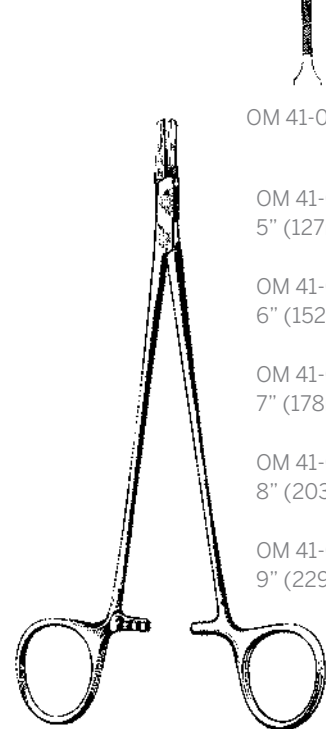

OM 41-0240

OM 41-0240
5" (127mm)

OM 41-0242
6" (152mm)

OM 41-0244
7" (178mm)

OM 41-0246
8" (203mm)

OM 41-0248
9" (229mm)

RYDER MICRO NEEDLE HOLDER
Serrated carbide

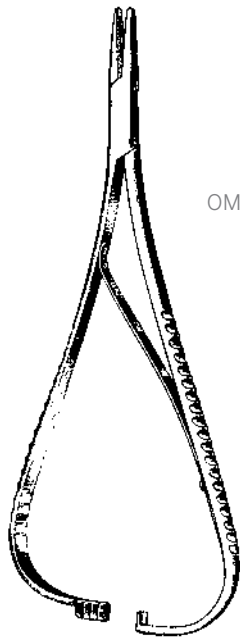

OM 42-0198

OM 41-0198
5 1/2" (140mm)

Carbide
OM 41-0200
5 1/2" (140mm)

MATHIEU NEEDLE HOLDER
Serrated

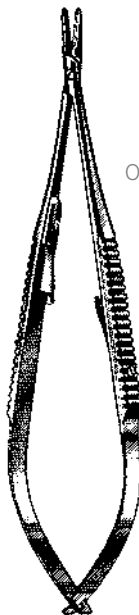

OM 42-0186

OM 42-0188

OM 42-0186
straight

OM 42-0188
curved

Carbide
OM 42-0190
straight

OM 42-0192
curved

CASTROVIEJO MICRO NEEDLE HOLDER
5 1/2" (140mm) smooth, with lock



OM 42-0196

OM 42-0198

OM 42-0196
straight

OM 42-0198
curved

CASTROVIEJO MICRO NEEDLE HOLDER
5 1/2" (140mm) extra delicate, smooth, with lock

OAL = Overall Length
 WL = Working Length
 FR = French Gauge (1 french = .33mm)

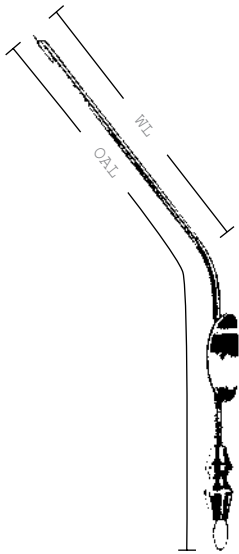

	OAL	FR	WL
OM 42-0832	5 1/2" (140mm)	3	75mm
OM 42-0834	5 1/2" (140mm)	5	75mm
OM 42-0836	5 1/2" (140mm)	7	75mm

BARON SUCTION TUBE

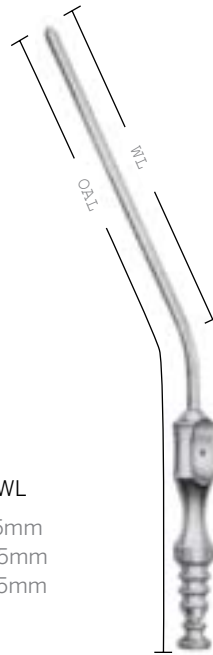

	OAL	FR	WL
OM 42-0823	7" (178mm)	6	90mm
OM 42-0824	7" (178mm)	7	90mm
OM 42-0825	7" (178mm)	8	90mm
OM 42-0826	7" (178mm)	10	90mm
OM 42-0827	7" (178mm)	11	90mm
OM 42-0830	7" (178mm)	12	90mm
OM 42-0823L	9" (229mm)	6	130mm
OM 42-0824L	9" (229mm)	7	130mm
OM 42-0825L	9" (229mm)	8	130mm
OM 42-0826L	9" (229mm)	10	130mm
OM 42-0827L	9" (229mm)	11	130mm
OM 42-0830L	9" (229mm)	12	130mm

FRAZIER SUCTION TUBE

Angled 30°

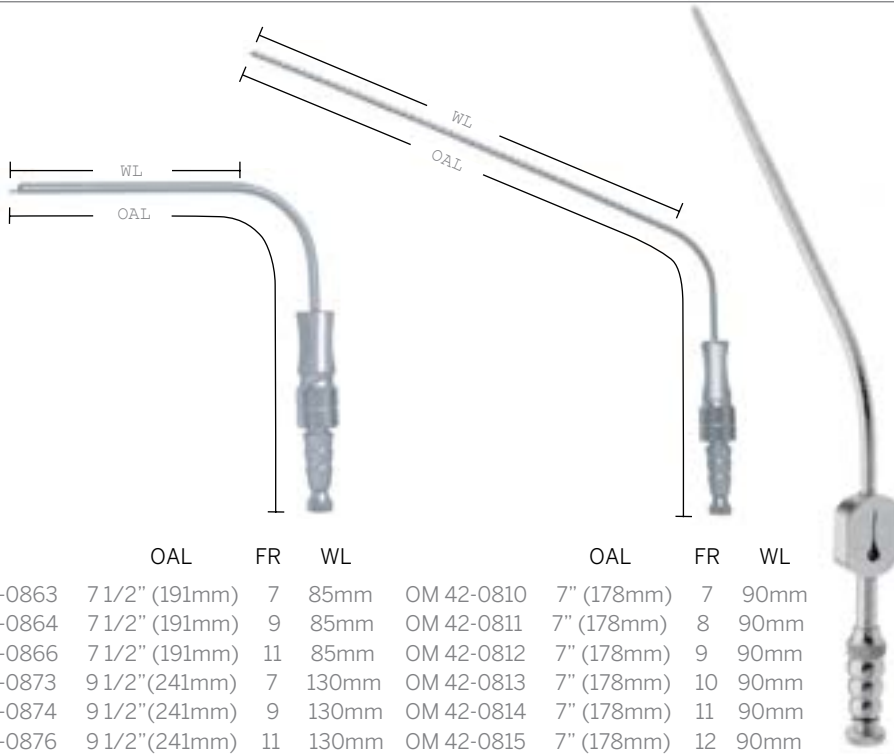

Tear drop opening allows surgeon to regulate force of suction.

	OAL	FR	WL		OAL	FR	WL
OM 42-0863	7 1/2" (191mm)	7	85mm	OM 42-0810	7" (178mm)	7	90mm
OM 42-0864	7 1/2" (191mm)	9	85mm	OM 42-0811	7" (178mm)	8	90mm
OM 42-0866	7 1/2" (191mm)	11	85mm	OM 42-0812	7" (178mm)	9	90mm
OM 42-0873	9 1/2" (241mm)	7	130mm	OM 42-0813	7" (178mm)	10	90mm
OM 42-0874	9 1/2" (241mm)	9	130mm	OM 42-0814	7" (178mm)	11	90mm
OM 42-0876	9 1/2" (241mm)	11	130mm	OM 42-0815	7" (178mm)	12	90mm

FRAZIER SUCTION TUBE

Angled 90°

FRAZIER SUCTION TUBE

Angled 75°

FUKUSHIMA SUCTION TUBE

SUCTION TUBES/SCALPEL HANDLES

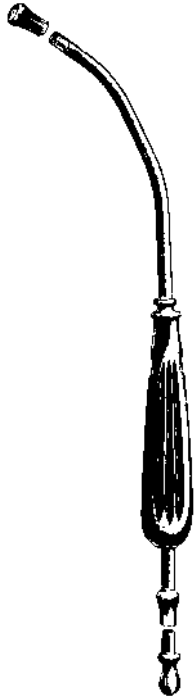

OM 58-0228
11 1/2" (292mm)
chrome

OM 58-0230
front tip only

YANKAUER SUCTION TUBE

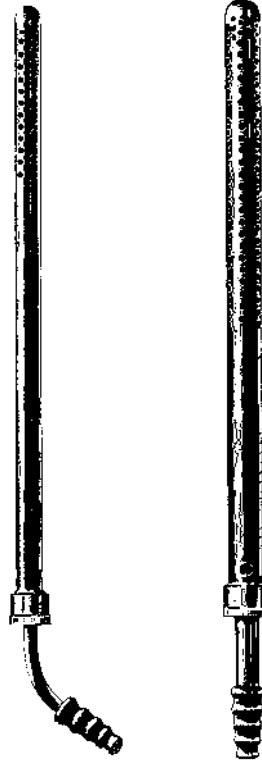

1 french= .33mm

OM 42-0844
23 french curved

OM 42-0852
30 french straight

POOLE SUCTION TUBE
9" (229mm) Chrome



OM 29-0070
for blades 61 through 67

**MINI SCALPEL HANDLE
#3K**



OM 29-0073

**SCALPEL HANDLE MINI
(BEAVER) #3K 6"**



OM 29-0071

**SCALPEL HANDLE MINI
(BEAVER) #3K 5"**



OM 29-0058
for blades
10 through 15

SCALPEL HANDLE #3



OM 29-0059
mm and cm graduations
for blades 10 through 15

SCALPEL HANDLE #3



OM 29-0060
for blades
20 through 25

SCALPEL HANDLE #4



OM 29-0061
extra long
8 1/2" (216mm)
for blades 10 through 15

SCALPEL HANDLE #3L



OM 29-0062
for blades 10 through 15

SCALPEL HANDLE #7



OM 29-0064
extra fine
for blades 10 through 15

SCALPEL HANDLE #9

PROBES AND PERCUSSION HAMMER



- OM 42-0608 4 1/2" (114mm)
- OM 42-0610 5" (127mm)
- OM 42-0612 5 1/2" (140mm)
- OM 42-0614 6" (152mm)
- OM 42-0616 8" (203mm)
- OM 42-0618 10" (254mm)
- OM 42-0620 12" (305mm)

PROBE WITH EYE
Malleable stainless

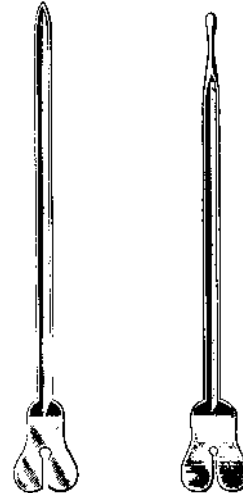

- With tongue tie
- OM 42-0646 4 1/2" (114mm)
 - OM 42-0647 5" (127mm)
 - OM 42-0648 5 1/2" (140mm)
 - OM 42-0649 6" (152mm)

- With probe and tongue tie
- OM 42-0654 5" (127mm)
 - OM 42-0655 5 1/2" (140mm)
 - OM 42-0656 6" (152mm)

GROOVED DIRECTORS

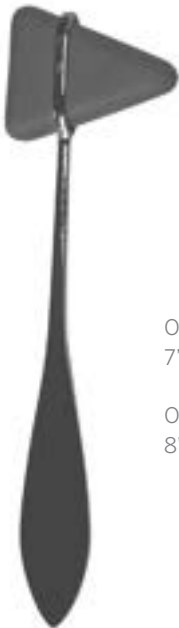

- OM 28-0460
7" (178mm) small
- OM 28-0468
8" (203mm) large

**TAYLOR
PERCUSSION HAMMER**

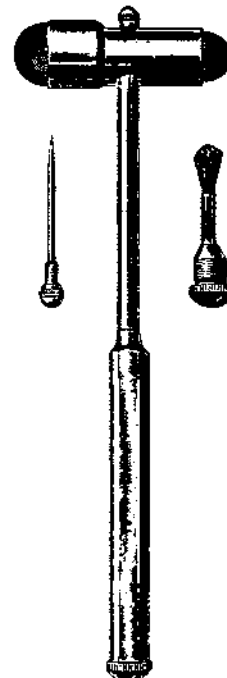

- OM 28-0492
7 3/4" (197mm)
chrome with brush and needle

**BUCK
NEUROLOGICAL HAMMER**

UTILITY CLIP MINI

OM CK-10

UTILITY CLIP MINI LARGE

OM CK-40



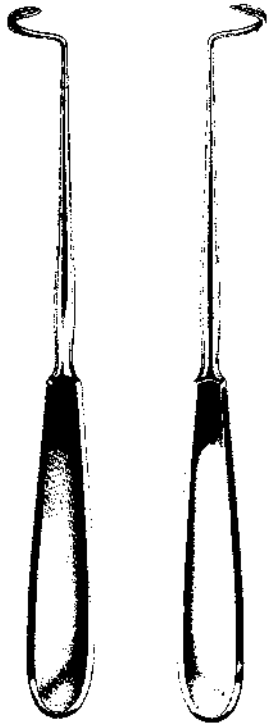

OM 42-0558 blunt left
OM 42-0560 blunt right
OM 42-0562 sharp left
OM 42-0564 sharp right

DESCHAMPS LIGATURE CARRIER
8" (203mm)



OM 53-0450
0.12mm
1x2 teeth

OM 53-0456
0.5mm
1x2 teeth

CASTROVIEJO MICRO TYING FORCEPS
4" (102mm) Straight with tying platform

Bipolar forceps
Available in most styles and tip sizes.



OM 68-0026
4" (102mm)
8mm platform
0.5mm tip

JEWELERS FORCEPS

FOOT AND ANKLE



SECTION D

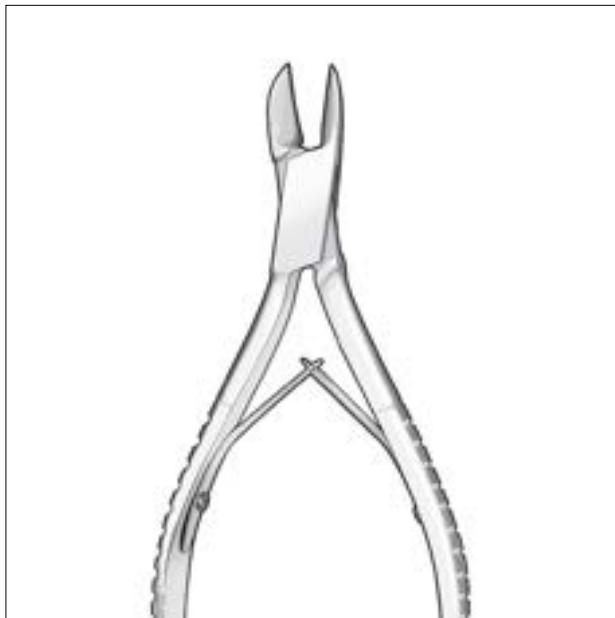

To split, cut, or remove finger and toe nails.

CONTENTS

Nail Splitters	1-2
Tissue Nippers	2
Nail Nippers	3-5
Osteotomy Guide	5
Nail Forceps	5-6
Nail Scissors	6
Hand Instruments	7-9
Dermal Instruments	10-11
Calcaneal/Metatarsal Spreaders	12

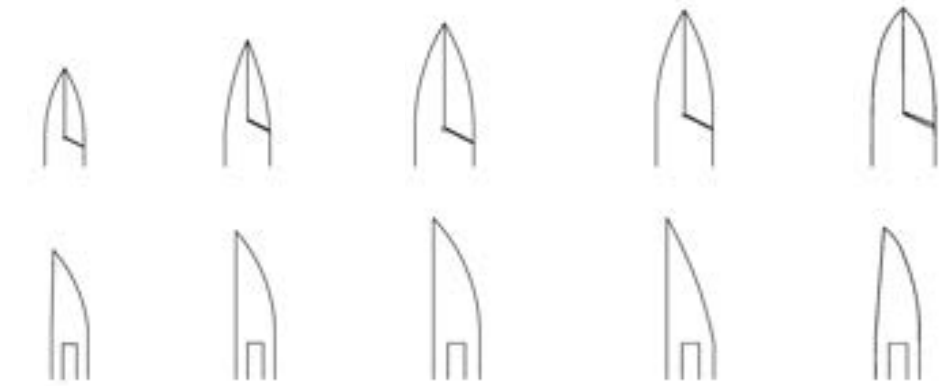

OM 69-0320
4" (102mm)
stainless

OM 69-0322
4 1/2" (114mm)
stainless

OM 69-0326
5" (127mm)
heavy jaw
stainless

OM 69-0327
5" (127mm)
narrow jaw
stainless

OM 69-0340
6" (152mm)
stainless

NAIL SPLITTER

Note: Replacement springs are available to order. Refer to the corresponding product number.

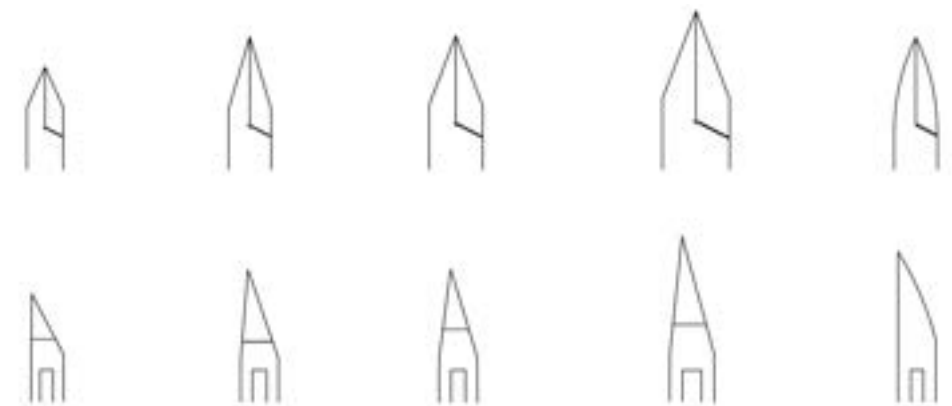

OM 69-0341
4" (102mm)
tapered
stainless

OM 69-0342
4 1/2" (114mm)
tapered
stainless

OM 69-0343
5" (127mm)
tapered
stainless

OM 69-0344
6" (152mm)
tapered
stainless*

OM 69-0448
4 1/2" (114mm)
delicate
stainless*

*Ideal for use in P/A

NAIL SPLITTER

Note: Our splitters have the true feel of superb craftsmanship. The cutting edge is expertly ground and specially heat treated. For a sure grip, our stainless splitters come with grooved handles.

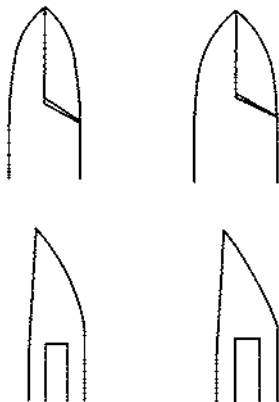

OM 69-0930
5" (127mm)

OM 69-0932
6" (152mm)

Short jaw design provides increased leverage for easier cutting of thick nails. Less strain on hand and splitter.

SHORT JAW NAIL SPLITTER

Stainless

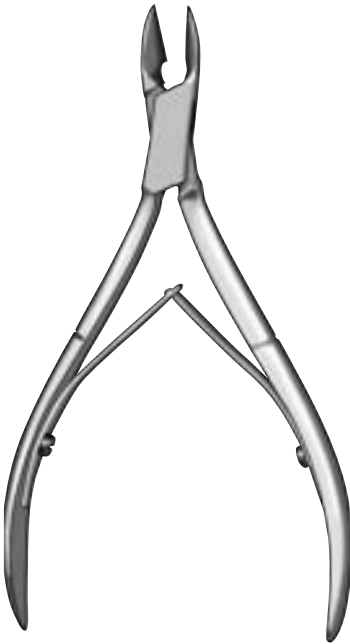

OM 69-0290
4" (102mm)
6mm stainless



OM 69-0291
4" (102mm)
9mm stainless



OM 69-0292
4 1/2" (114mm)
11mm stainless



OM 69-0294
5" (127mm)
14mm stainless

TISSUE NIPPER



NAIL NIPPER
Heavy

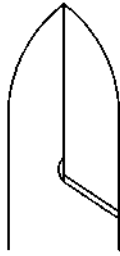

OM 69-0430
5 1/2" (140mm)
concave
stainless



OM 69-0432
5 1/2" (140mm)
straight
stainless



OM 69-0438
6 1/2" (165mm)
concave
super size
stainless



Double action helps prevent hand fatigue. Ideal for mycotic and onychauxis nails.



MYCOTIC NAIL NIPPER
6" (152mm) stainless double action
barrel spring

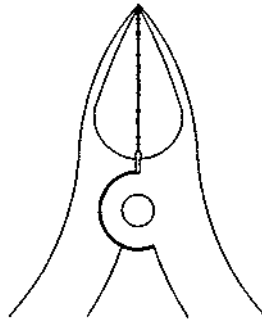

OM 69-0445
straight



OM 69-0446
concave

NAIL NIPPERS

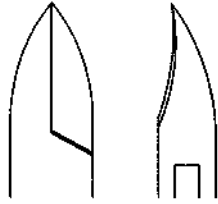
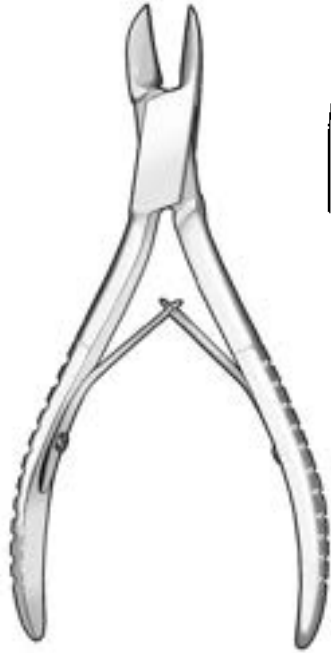

OM 69-0418
5 1/2" (140mm)
concave
narrow
stainless

NAIL NIPPER



OM 69-0410
4 1/2" (114mm)
concave
chrome
barrel spring

OM 69-0412
5 1/2" (140mm)
concave
chrome
barrel spring

NAIL NIPPER

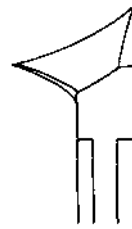

OM 69-0440
OM 69-0442



OM 69-0441

Angled concave
OM 69-0440 stainless, sharp end
OM 69-0441 stainless, blunt end
OM 69-0442 chrome, sharp end

NAIL NIPPER
5 1/2" (140mm)



OM 69-0258
4" (114mm)
6mm
chrome
ring handle

CUTICLE NIPPER



OM 69-0998
5" (125mm) arm
1.75" (45mm) blade

OSTEOTOMY GUIDE



Very delicate anvil
design slides easily
under nails.



OM 69-0348
5" (127mm)
anvil pattern
narrow blade
stainless

**INGROWN NAIL
FORCEPS**



OM 69-0792

OM 69-0793

OM 69-0792
3mm
narrow

OM 69-0793
6mm
broad

PLATYPUS NAIL REMOVING FORCEPS
5 1/2" (140mm)



Used to grasp nail spicules for removal.

OM 69-0352
5 1/2" (140mm)

**NAIL SPICULE
FORCEPS**

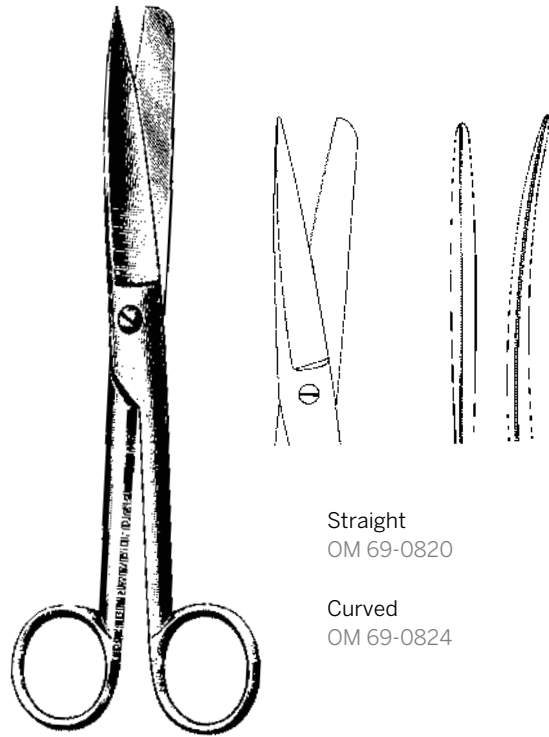

Straight
OM 69-0820

Curved
OM 69-0824

MOLESKIN SCISSORS
7 1/2" (191mm) One blade serrated

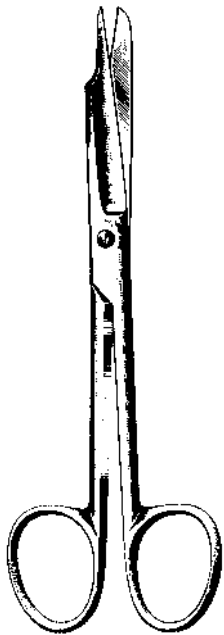

OM 69-0805
6" (152mm)
one serrated blade

**INGROWN NAIL
SPLITTING SCISSORS**



Curved
OM 69-0106
3 1/2" (89mm)

NAIL SCISSORS

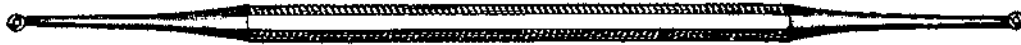

HAND INSTRUMENTS, DOUBLE ENDED SOLID OCTAGON HANDLES

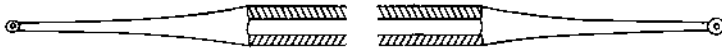

CURETTE EXCAVATOR

OM 69-0488
5 1/2" (140mm)
double ended
1.5 and 2.0mm with hole

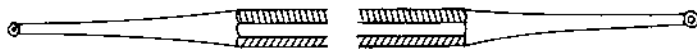

CURETTE EXCAVATOR

OM 69-0492
5 1/2" (140mm)
double ended
1.5 and 2.5mm with hole

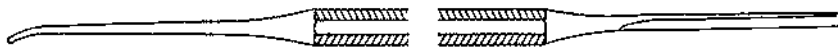

PROBE AND PACKER

OM 69-0495
6" (152mm)
double ended

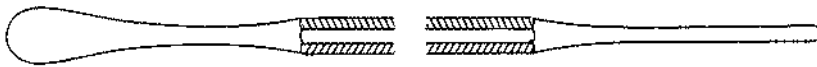

SPATULA AND PACKER

OM 69-0498
5 3/4" (146mm)
double ended

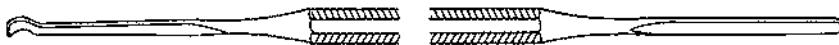

EXCAVATOR AND PACKER

OM 69-0502
5 3/4" (146mm)
double ended

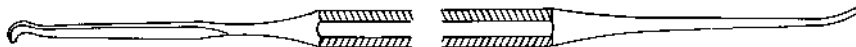

EXCAVATOR AND PROBE

OM 69-0518
6" (152mm)
double ended



NAIL RASP

OM 69-0538
6 3/4" (172mm)
double ended, angled

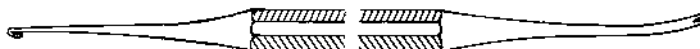

JOHNSON-TUCKER HOOK AND FORK

OM 69-0790
6 1/2" (165mm)
double ended, delicate





HAND INSTRUMENTS, SINGLE ENDED SOLID OCTAGON HANDLES





CURETTE EXCAVATOR (VERUCCA)

OM 69-0457
5", 1.0mm without hole
single ended

With McGlamry
Bullneck, Will resist
bending.

1.0mm 
1.5mm 

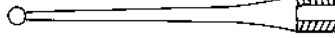

2.0mm 
2.5mm 



CURETTE EXCAVATOR

OM 69-0457
5", 4mm without hole
single ended

OM 69-0461 5", 1.5mm
OM 69-0465 5", 2.5mm
OM 69-0463 5", 2.0mm

1.0mm 
1.5mm 

2.0mm 
2.5mm 

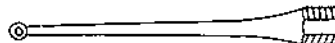

CURETTE EXCAVATOR

OM 69-0468
5", 1.0mm with hole
single ended

OM 69-0478 5", 1.5mm
OM 69-0484 5", 2.5mm
OM 69-0480 5", 2.0mm

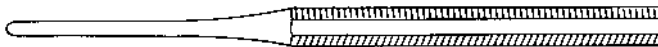

NUCLEUS KNIFE

OM 69-0524
5 1/4" small
single ended



OM 69-0528
5 1/4" large
single ended

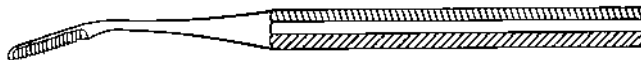

BONE FILE #92A

OM 69-0530
6" (152mm) single ended

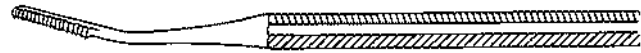

BONE FILE #92B

OM 69-0534
6" (152mm) single ended

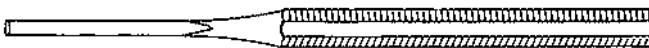

NAIL SPLITTER

OM 69-0557 5" small blade straight, single ended
OM 69-0562 5" small blade angled, single ended

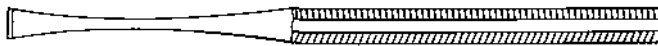

NAIL SPLITTER

OM 69-0560 5" large blade straight, single ended
OM 69-0568 5" large blade angled, single ended

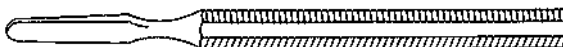

LOCKE ELEVATOR

OM 69-0579
4 1/2" (114mm) narrow blade
single ended

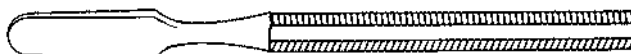

OM 69-0590
5" (127mm) wide blade
single ended

With McGlamry
Bullneck, Will resist
bending.

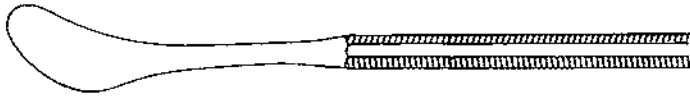
**GOLF STICK KNIFE #41**

OM 69-0618
5 1/2" (140mm)
single ended

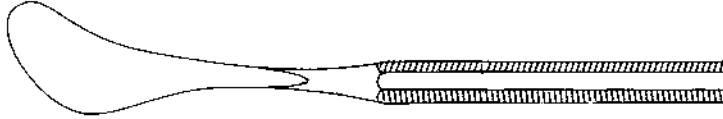
**GOLF STICK KNIFE #43**

OM 69-0620
5 1/2" (140mm)
single ended

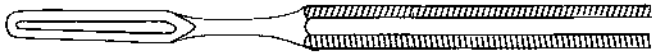
**INGROWN NAIL INSTRUMENT**

OM 69-0595
5" (127mm)
single ended

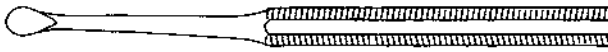
**SOFT CORN KNIFE**

OM 69-0622
5" (127mm)
round blade
straight, single ended

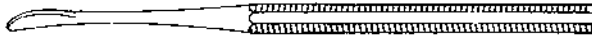
**SOFT CORN SPOON KNIFE**

OM 69-0623
5" (127mm) oval blade
slightly curved, single ended

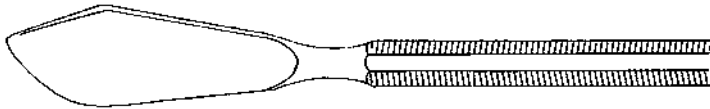
**CORN KNIFE**

OM 69-0625
5 1/2" (140mm) curved
single ended

**CHISEL**

OM 69-0630
5 1/4" (133mm) medium blade
straight edge
single ended

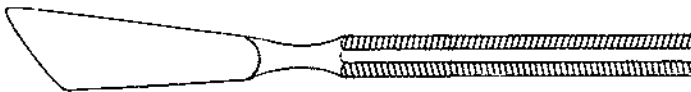
**CHISEL**

OM 69-0640
5 1/4" (133mm) large blade
curved edge
single ended

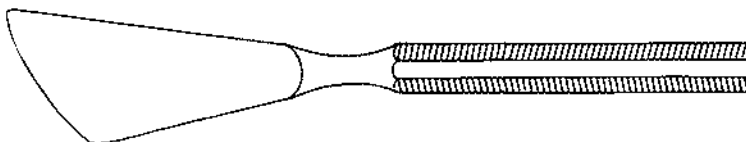
**CHISEL**

OM 69-0645
5 1/4" (133mm) extra large blade
curved edge
single ended

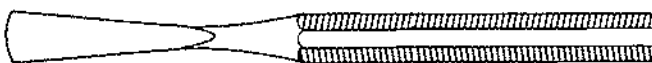
**CHISEL**

OM 69-0650
5 1/4" (133mm) spade pattern
curved edge
single ended



OM 29-0580
3 3/4" (95mm)
standard
crimped loops

OM 29-0582
3 3/4" (95mm)
extra fine
crimped loops

**SCHAMBERG COMEDONE
EXTRACTOR**



OM 29-0584
3 3/4" (95mm)
square loops

**SCHAMBERG COMEDONE
EXTRACTOR**

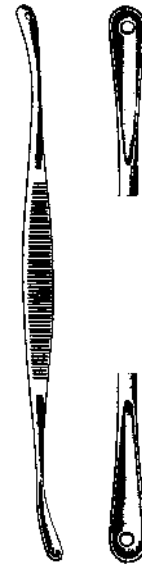

OM 29-0592
5 3/4" (146mm)
fenestrated spoon
ends

**UNNA COMEDONE
EXTRACTOR**



OM 29-0604
6 1/4" (159mm)
one fenestrated cup
and curved lancet
with cap

**ORTHOMED COMEDONE
EXTRACTOR**



OM 29-0606
5" (127mm)
one fenestrated cup
and lancet blade with
cap

**GREG COMEDONE
EXTRACTOR**



OM 29-0566
4 1/2" (114mm)
with lancet
and one fenestrated
cup

**SAALFELD COMEDONE
EXTRACTOR**



OM 29-0511 2mm
 OM 29-0512 3mm
 OM 29-0513 4mm
 OM 29-0514 5mm
 OM 29-0515 6mm
 OM 29-0517 8mm

KEYES PUNCH
 4" (102mm)



OM 29-0495 1mm
 OM 29-0496 2mm
 OM 29-0497 3mm
 OM 29-0498 4mm
 OM 29-0499 5mm
 OM 29-0500 6mm

FOX CURETTE
 5 1/2" (140mm) round

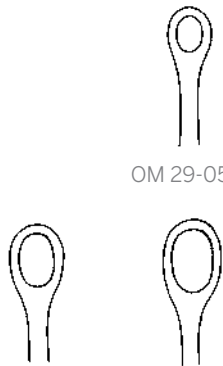

OM 29-0503
 OM 29-0505
 OM 29-0507

OM 29-0503 #1 small
 OM 29-0505 #2 medium
 OM 29-0507 #3 large

PIFFARD CURETTE
 5 1/2" (140mm) oval

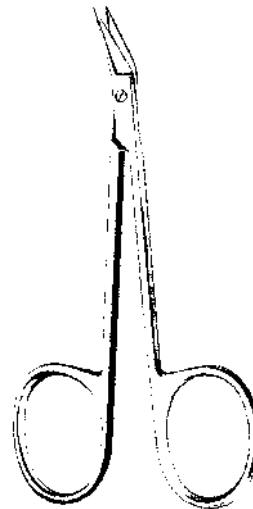

OM 35-0515
 angled on flat
 sharp outside
 edges

BIRO DERMAL NAEVUS SCISSORS
 4" (102mm)

RETRACTORS

Provides excellent joint exposure without blocking intra-articular or osteotomy access. Helps prevent slippage or falling out of the joint by placing the arms on either side of the area to be distracted, driving two K-Wires and opening the joint.



OM 48-0223
6 3/4" (171mm)
for up to .062"
(1.6mm)

OM 48-0224
6 3/4" (171mm)
for up to 7/64"
(2.8mm)



OM 90-1880
7" (178mm)
Smooth pads 15mm x 12mm

OM 90-1881
7" (178mm)
Grooved pads 15mm x 12mm

JOINT AND CALCANEAL SPREADER

CALCANEAL SPREADER

OM 69-0990
4 1/2" (114mm)
8mm width X 28mm
depth blades

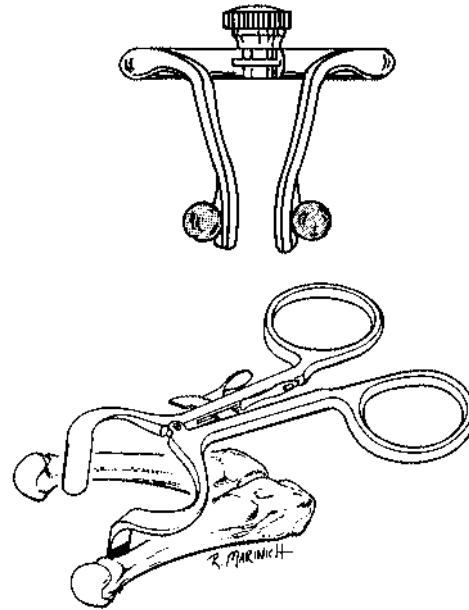

Note:

- Specially designed thin serrated blades fit anatomically correct against the metatarsals.
- Precise design and German manufacture assure slip-proof hold on metatarsals.
- Affords excellent visibility for the surgeon.
- Designed by Dr. Kenneth Cox.

CAST ROOM INSTRUMENTS



SECTION E

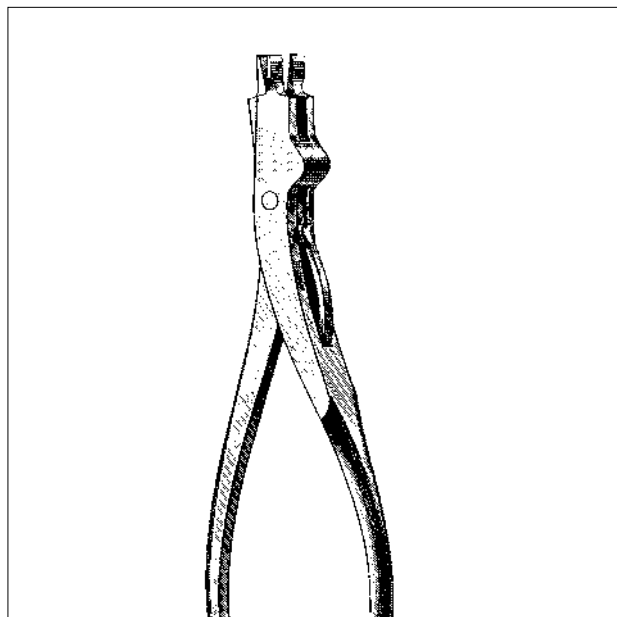

To cut or break bandages, stockinette, drapes, felt, plaster or aluminum casts.

CONTENTS

Scissors and Shears	1-3
Saws	3
Knives	3
Cast Breakers	3-4
Cast Spreaders	4-5

ORTHO+MED
The Surgical Instrument Specialists

SUPER-CUT BANDAGE SCISSORS

OrthoMed developed these remarkably sharp scissors in response to the demands of doctors, nurses, and other O.R. personnel.

Hospital tests show that these scissors cut multiple layers of stockinette, bandages, drapes, and moleskin with ease.

- Very little hand strength is required for cutting, putting less strain on thumb and forearm.
- Perfect cutting control because you don't have to force them to cut.
- Scissors cut faster, saving critical time in the O.R.
- Retain their sharpness longer than ordinary scissors.
- Not recommended for cutting plaster.

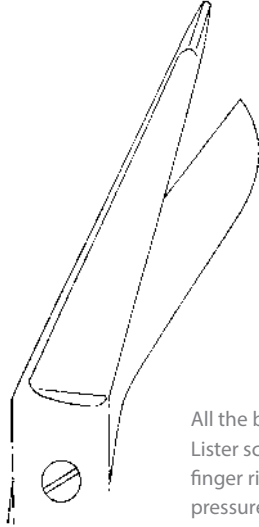

All the benefits of our Super-Cut Lister scissors plus an oversized finger ring, which helps relieve pressure on the third metacarpal.

OM 35-0214
8" (203mm)

SUPER-CUT LISTER BANDAGE SCISSORS WITH LARGE FINGER RING

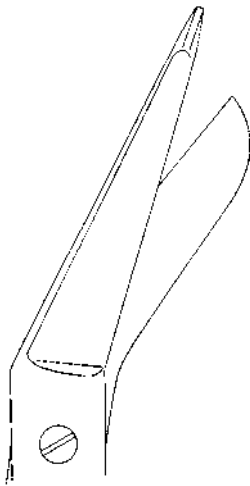

OM 35-0210

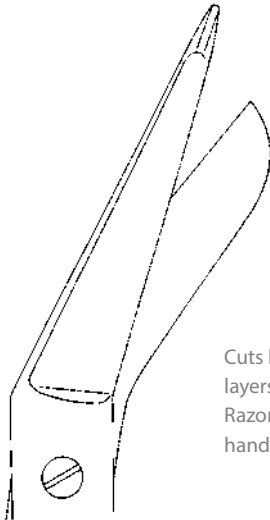

OM 35-0212

Cuts bandages and multiple layers of dressings with ease. Razor-sharp blades reduce hand fatigue.

OM 35-0210
5 1/2" (140mm)
stainless

OM 35-0212
7 1/4" (184mm)
stainless

SUPER-CUT LISTER BANDAGE SCISSORS

PLASTER CAST SCISSORS AND SHEARS

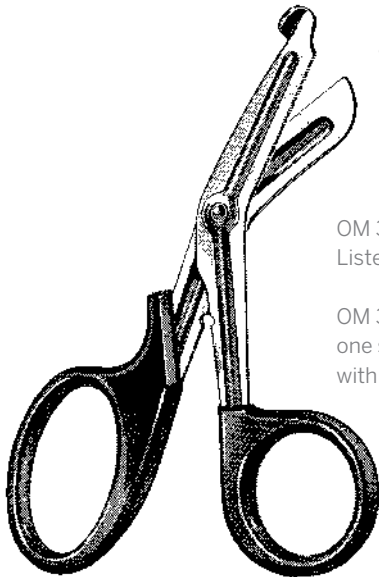

For light plaster and cloth.

OM 31-0832 6" (152mm)
Lister-type (not pictured)

OM 31-0830 7 1/2" (191mm)
one serrated blade
with autoclavable plastic finger rings

UTILITY SHEARS

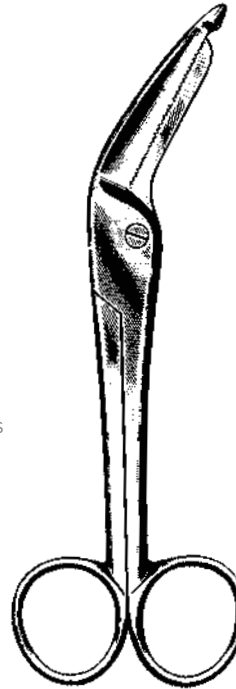

For light weight plaster or aluminum casts.

OM 31-0834
7 1/2" (191mm)
one serrated blade

HERCULES SCISSORS



Effective for cloth or cotton wadding.

OM 31-0836
8" (203mm)
one serrated blade
with wire cutting notch

**ORTHOMED
UTILITY SHEARS**

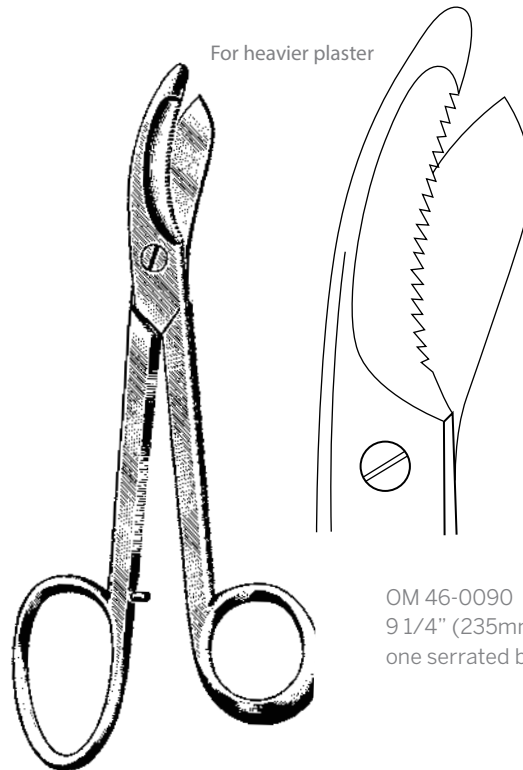

For heavier plaster

OM 46-0090
9 1/4" (235mm)
one serrated blade

BRUNS SHEARS

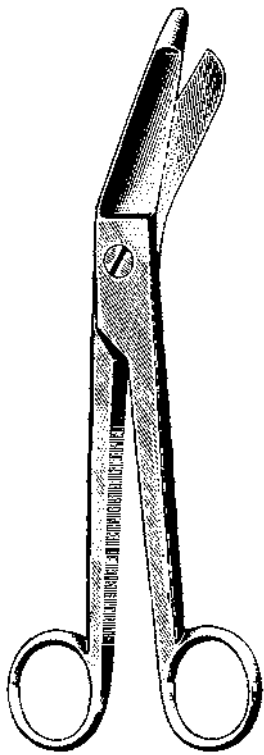

Useful for cutting
tape and bandages.

OM 46-0060
8" (203mm)

ESMARCH SHEARS

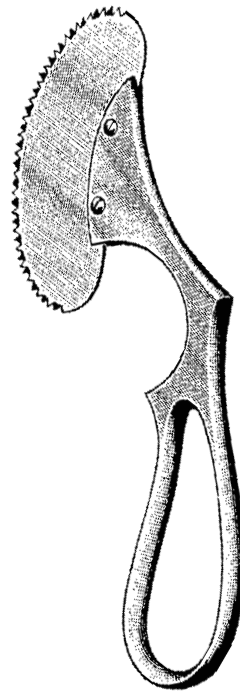

OM 46-0056
6" (152mm)
with stainless blade
chrome handle

ENGEL PLASTER SAW



OM 46-0058
7" (178mm)
with stainless handle

REINER PLASTER KNIFE



For lightweight
cast breaking
and trimming.

OM 46-0188
7" (178mm)
deep serrated tips



PEDIATRIC CAST BREAKER



OM 46-0186
7" (178mm)
small

OM 46-0184
9 1/2" (241mm)



For cast removal.

PLASTER BREAKER WOLFF (BOEHLER)
deep serrated tips

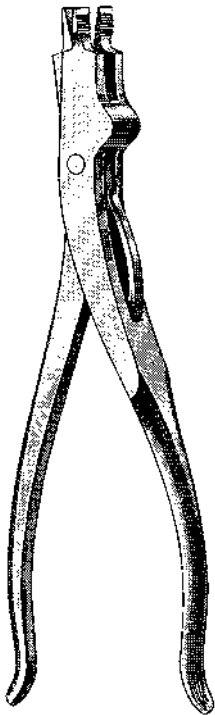

OM 46-0134
9" (229mm) serrated
3 prongs

OM 46-0133
9" (229mm) serrated
3 prongs

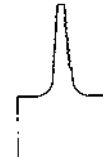
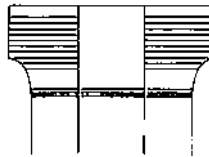

To relieve cast pressure
or for cast removal. One
handed operation.

**ORTHOMED
CAST SPREADER**

WALTON CAST SPREADER

To relieve cast pressure
or for cast removal.

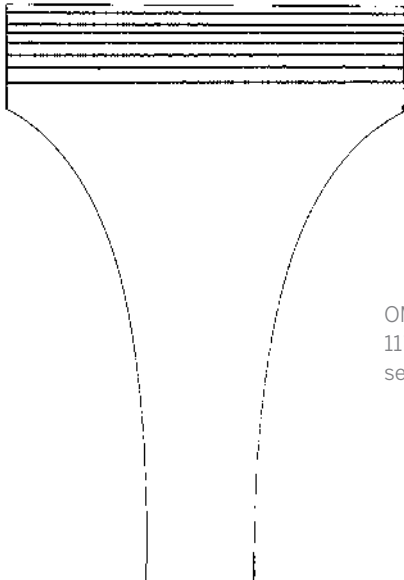
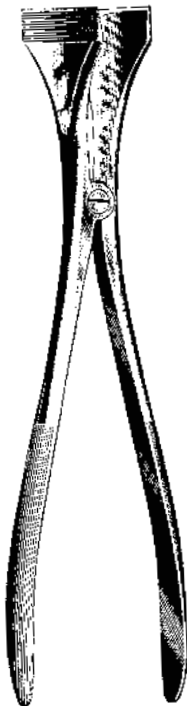

OM 46-0138
11" (279mm)
serrated

**HENNIG PLASTER
SPREADER**

For cast removal.

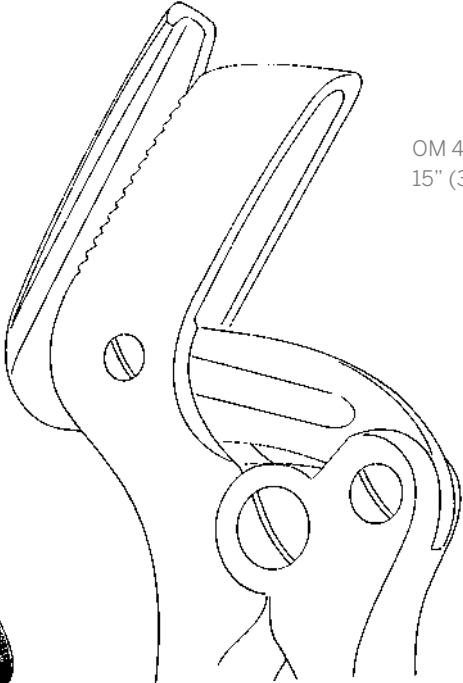
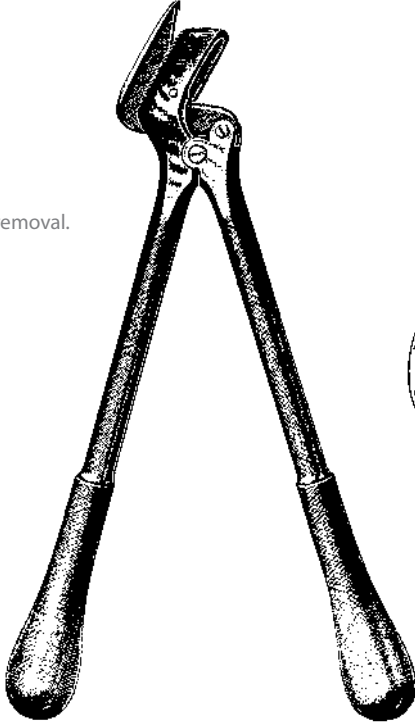

OM 46-0156
15" (381mm)

STILLE PLASTER SHEARS

BONE FILES AND RASPS



SECTION F



To smooth, sculpt and clean bone.

CONTENTS

Bone Files	1-7
Bone Rasps	7
Canal Rasp	8



OM 69-0534
6" (152mm)
single ended
2mm width angled
plain serrations
delicate



OM 69-0530
6" (152mm)
single ended
2mm width angled
plain serrations
delicate

BONE FILE #92B

BONE FILE #92A

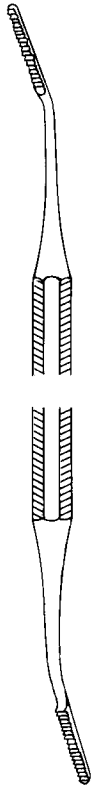

OM 69-0538
6 3/4" (172mm)
double ended
2mm width angled

NAIL RASP #93

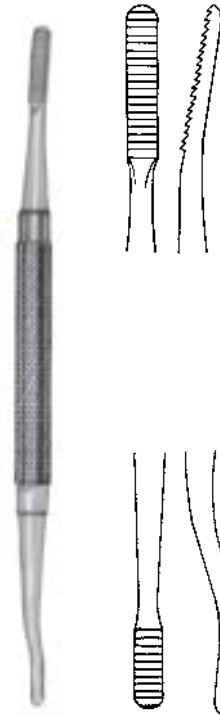

OM 58-0070
7" (178mm)
double ended
3mm and 4mm width

BONE RASP #64

BONE FILES AND RASPS

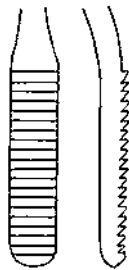
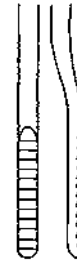
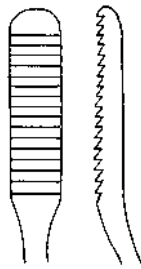
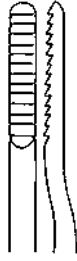

OM 69-0541

OM 69-0540

OM 69-0541
7" (178mm)
double ended 3mm and 4mm width

OM 69-0540
8 1/2" (216mm)
double ended 6mm width

POLOKOFF RASP

Plain serrations

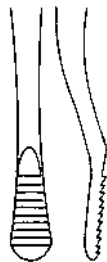
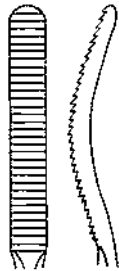

OM 69-0542
7" (178mm)
double ended
5mm width
plain serrations

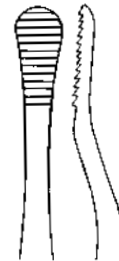

OM 69-0543
7" (178mm)
double ended
7mm and 5mm width
plain serrations

BONE FILE #10

BONE FILE #12

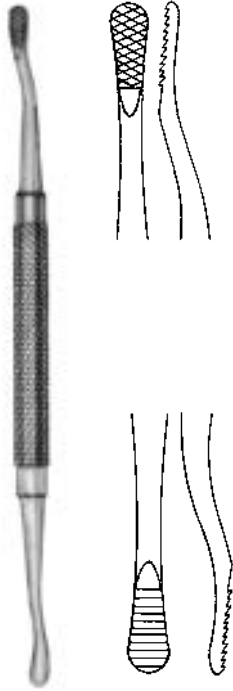

OM 69-0544
7" (178mm)
double ended
5mm width
plain and cross serrations

BONE FILE #12A

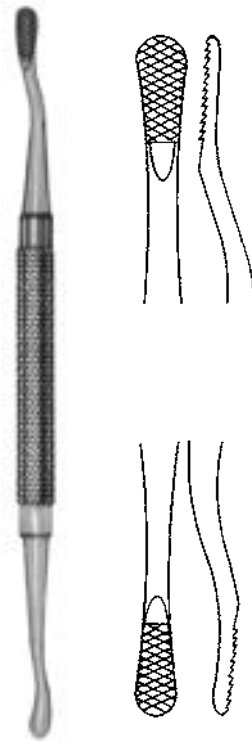

OM 69-0545
7" (178mm)
double ended
5mm and 7mm width
cross serrations

BONE FILE #12CA

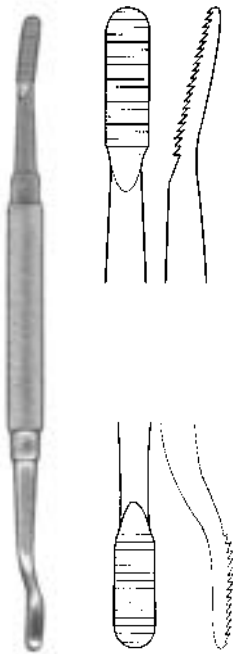

OM 69-0546
7" (178mm)
double ended
6mm and 5mm width
plain serrations

BONE FILE #33

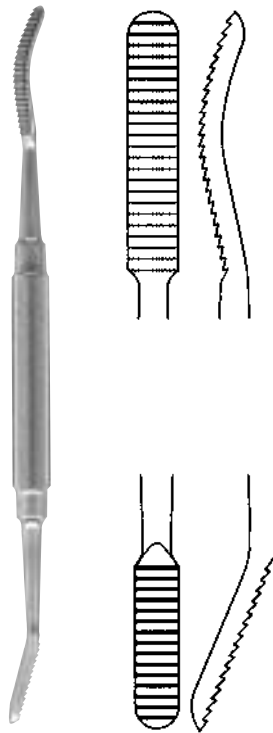

OM 69-0549
7 1/4" (178mm)
double ended
6mm and 5mm width
plain serrations

BONE FILE #45

BONE FILES AND RASPS

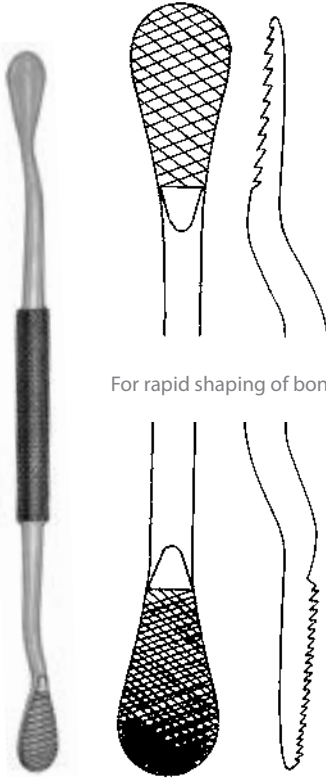

OM 69-0547
 8 1/2" (216mm)
 double ended
 13mm width
 fine and coarse
 cross serrations

For rapid shaping of bone.

BONE RASP

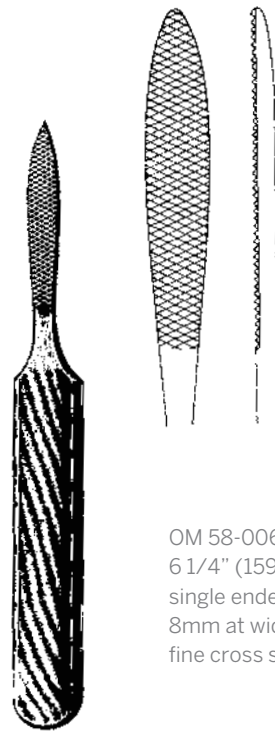

OM 58-0068
 6 1/4" (159mm)
 single ended
 8mm at widest point
 fine cross serrations

JOSEPH RASP



OM 58-0072

OM 58-0072
 7 1/2" (191mm)
 fine
 single ended
 8mm width



OM 58-0073

OM 58-0073
 7 1/2" (191mm)
 coarse
 single ended
 8mm width

LEWIS RASP
 Plain serrations

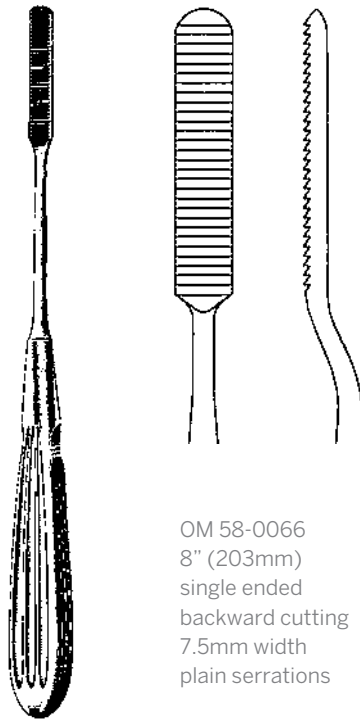

OM 58-0066
 8" (203mm)
 single ended
 backward cutting
 7.5mm width
 plain serrations

COTTLE RASP



OM 58-0060
7" (178mm) single ended
backward cutting
10mm width

MALTZ RASP



OM 58-0062
8 1/4" (210mm)
double ended
8mm width
forward and
backward cutting

MALTZ RASP IMPROVED

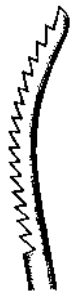

OM 58-0050

OM 58-0050
8 1/4" (210mm)
single ended
forward cutting
9mm width

OM 58-0052
8 1/4" (210mm)
single ended
backward cutting
9mm width

AUFRICHT RASP

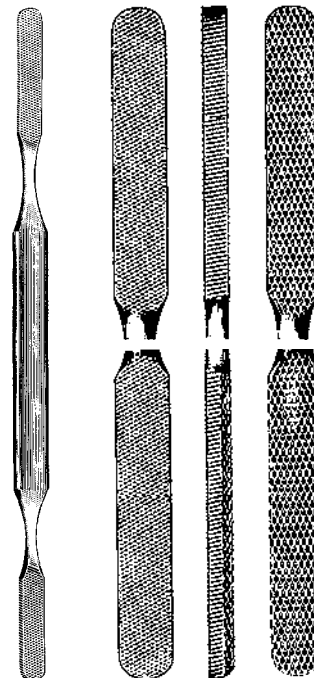

OM 46-0655
8 1/2" (216mm)
double ended
fine and coarse teeth
4-sided, convex
and flat blades
8mm width

FOMON RASP

BONE FILES AND RASPS

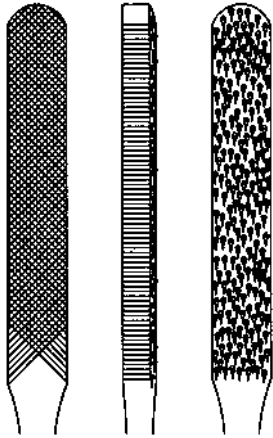

OM 46-0653
 8 1/2" (216mm)
 double ended
 fine and coarse teeth
 4-sided, convex and
 flat blades
 8mm width

KLEINERT KUTZ RASP



BONE FILE

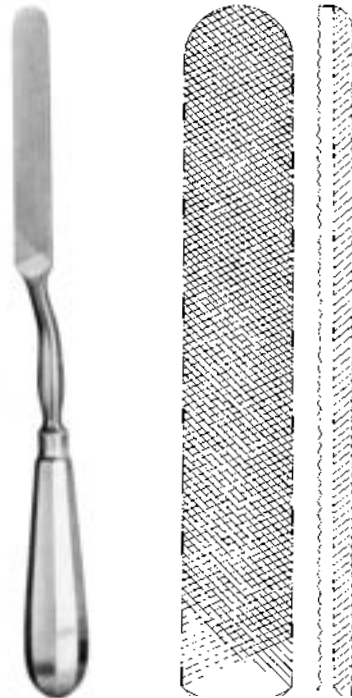

OM 46-0650
 9 1/2" (241mm)
 single ended
 bayonet shank
 half round blade
 fine teeth
 15mm width

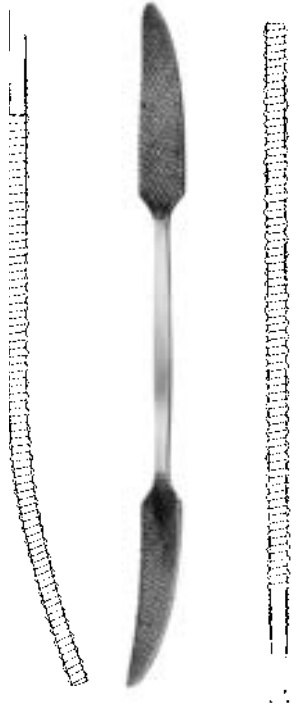

PUTTI BONE RASP

OM 46-0654
 10 1/2" (267mm)
 double ended
 flat blades
 18mm width tapers to 4mm
 one end curved up
 one end curved sideways

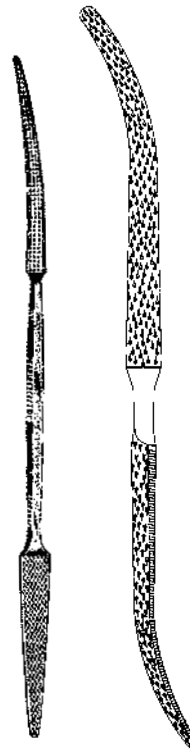

PUTTI BONE RASP

OM 46-0652
 12" (305mm)
 double ended
 one round blade
 10mm width tapers to 4mm
 and one half round blade
 15mm width tapers to 5mm

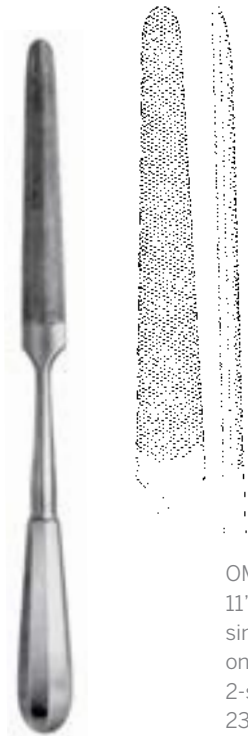

OM 46-0705
11" (280mm)
single ended
one round blade
2-sided, convex and flat blade
23mm width tapers to 6mm

BONE FILE



OM 69-0600
9.5" (241mm)
3.5mm width
angled up
plain serrations

RASP SALEHI LUMBAR FORAMINAL



Patented system

OM 46-0076 Complete set
OM 46-0077 Handle single ended
OM 46-0078 Handle double ended
OM 46-0079 Key

Individual Rasps

OM 46-0081	0.8	extra fine
OM 46-0082	1.0	very fine
OM 46-0083	1.2	fine
OM 46-0084	1.4	fine
OM 46-0085	1.6	medium fine
OM 46-0086	1.8	medium
OM 46-0087	2.0	medium
OM 46-0088	2.2	medium course
OM 46-0089	2.4	course/rough
OM 46-0090	2.6	very course
OM 46-0091	2.6	diamond coated

RASP SET w/INSERTS



OM 90-4991
11" (280mm) Curved

CANAL FINDER RASP

ELEVATORS, AWLS, AND BONE HOOKS



SECTION G



To elevate, dissect, scrape and apply traction to bone and soft tissue.

CONTENTS

Elevators	1-16
Probes	2
Raspatories	4-5
Bone Awls	17-18
Bone Hooks	19-21

ORTHO+MED
The Surgical Instrument Specialists



OM 57-0620

OM 57-0622

OM 57-0620 5 1/2" (140mm) semi-sharp 4mm
OM 57-0622 5 1/2" (140mm) semi-sharp 5mm

MCKENTY ELEVATOR



OM 57-0612
7" (178mm)
double ended
6mm semi-sharp end
and 5mm sharp end

OHL ELEVATOR



OM 57-0613
7 1/2" (191mm)
double ended
6.5mm sharp end
and 6.5 blunt end

OM 57-0614
7 1/2" (191mm)
double ended
5mm sharp end
and 5mm blunt end

FREER ELEVATOR
5 1/2" (140mm) oval



OM 57-0616
7 1/2" (191mm)
double ended
8mm semi-sharp end
and 8mm blunt end

ALLERDYCE ELEVATOR AND DISSECTOR

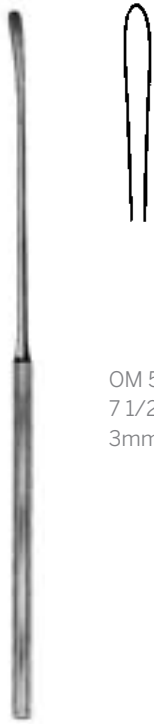

OM 57-0618
7 1/2" (191mm)
3mm blunt

SACHS NERVE ELEVATOR

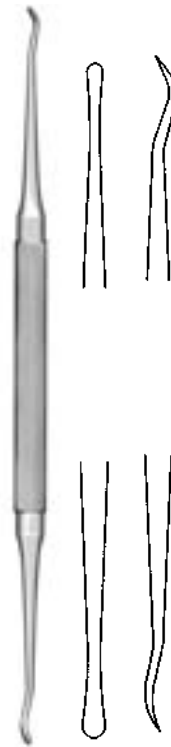

OM 57-0615
7 3/4" (195mm)
2mm x 3mm sharp ends

**KLEINERT KUTZ
ELEVATOR AND DISSECTOR**

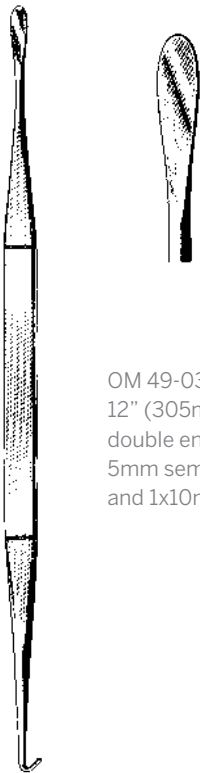

OM 49-0320
12" (305mm)
double ended
5mm semi-sharp end
and 1x10mm blunt hook

SMITHWICK HOOK AND DISSECTOR

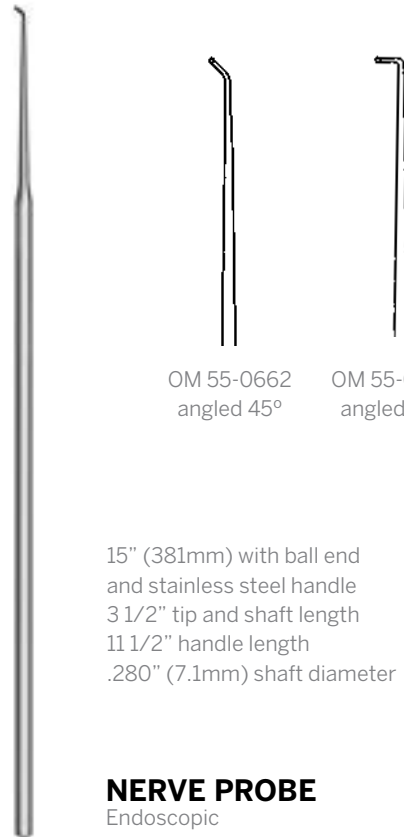

OM 55-0662 OM 55-0664
angled 45° angled 90°

15" (381mm) with ball end
and stainless steel handle
3 1/2" tip and shaft length
11 1/2" handle length
.280" (7.1mm) shaft diameter

NERVE PROBE
Endoscopic

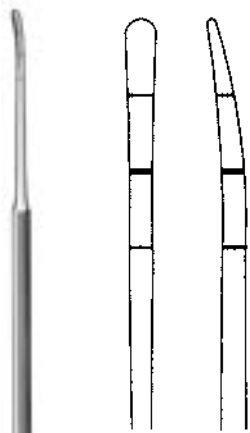

OM 55-0654
 15" (381mm)
 blunt with stainless steel handle
 .16" (4mm) tip width
 3 1/2" tip and shaft length
 11 1/2" handle length
 .280" (7.1mm) shaft diameter

PENFIELD ELEVATOR
 Endoscopic

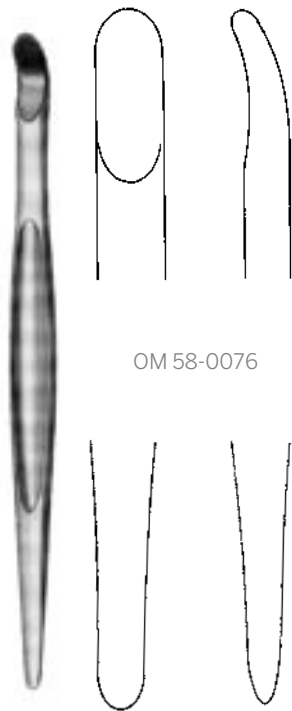

OM 58-0076

OM 58-0075
 6 1/2" (165mm)
 sharp, double ended
 5mm end and
 9mm end

OM 58-0076
 6 1/2" (165mm)
 blunt, double ended
 5mm end and
 9mm end

SAYRE PERIOSTEAL ELEVATOR

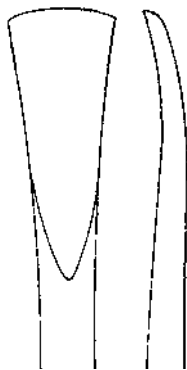

OM 49-0322
 7 1/2" (191mm)
 15mm sharp
 curved edge

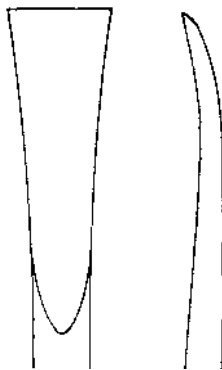

OM 49-0324
 7 1/2" (191mm)
 15mm sharp
 straight edge

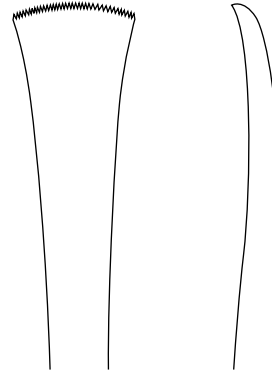

OM 49-0326
 7 1/2" (191mm)
 15mm serrated curved
 edge

CUSHING PERIOSTEAL ELEVATOR

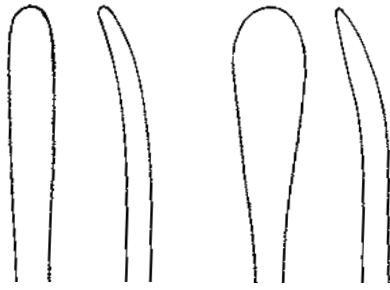

OM 46-0208 OM 46-0210

OM 46-0208
7 3/4" (195mm)
narrow
6mm blunt

OM 46-0210
7 3/4" (195mm)
broad
10mm blunt

LANE PERIOSTEAL ELEVATOR

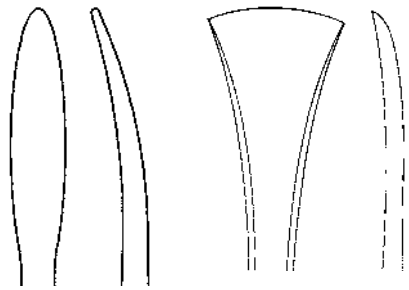

OM 46-0222 OM 46-0224

OM 46-0222
7 3/4" (195mm)
6mm narrow
blunt edge

OM 46-0224
7 3/4" (195mm)
17mm broad
sharp edge

LANGENBECK PERIOSTEAL ELEVATOR



OM 58-0085
7" (178mm)
16mm sharp

SEDILLOT PERIOSTEAL ELEVATOR

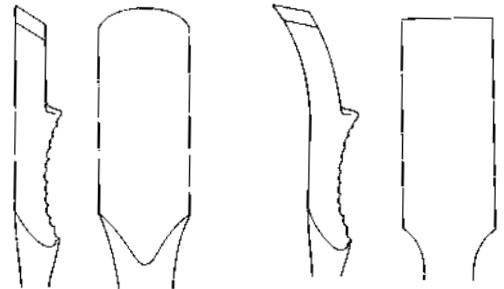

OM 58-0106 OM 58-0108

OM 58-0106
6" (152mm)
sharp
13mm curved edge
straight blade

OM 58-0108
6" (152mm)
sharp
13mm straight edge
curved blade

FARABEU PERIOSTEAL RASPATORY

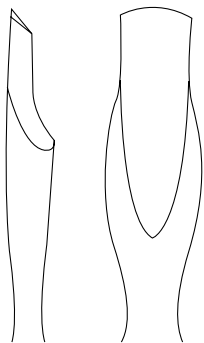

OM 58-0112
6 3/4" (172mm)
sharp

**KIRRISSION PERIOSTEAL
RASPATORY**

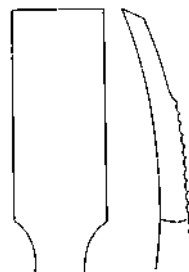

OM 58-0110
8" (203mm)
12mm sharp

**ALEXANDER PERIOSTEAL
RASPATORY**

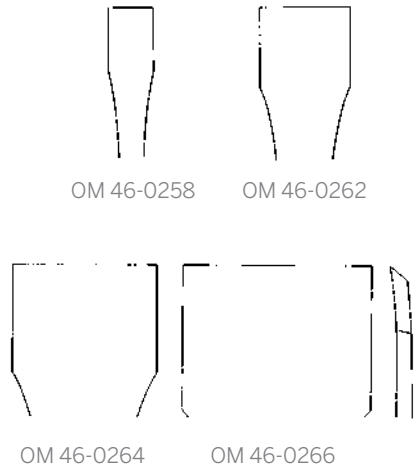

OM 46-0258	7"	1/4" width
OM 46-0260	7 1/2"	3/8" width
OM 46-0262	7 1/2"	1/2" width
OM 46-0263	7 1/2"	5/8" width
OM 46-0264	8"	3/4" width
OM 46-0266	8 1/4"	1" width

KEY PERIOSTEAL ELEVATOR
Sharp edge

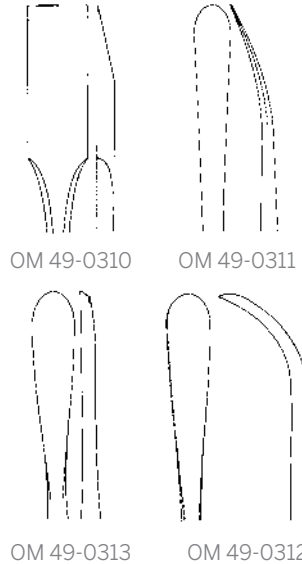

OM 49-0310	6 3/4" sharp	7mm	straight
OM 49-0311	6 3/4" blunt	7mm	curved
OM 49-0313	6 3/4" semi-sharp	7mm	straight
OM 49-0312	6 3/4" semi-sharp	7mm	curved

aka Joker Elevator

ADSON PERIOSTEAL ELEVATOR

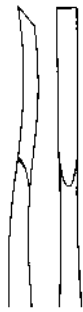

Phenolic handles
are autoclavable
to 290°F (143°C).

OM 46-0206
7 1/4" (184mm)
sharp
3mm straight edge
curved blade
phenolic handle

PERIOSTEAL ELEVATOR

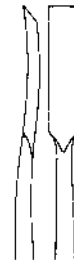

Phenolic handles
are autoclavable
to 290°F (143°C).

OM 46-0207
7 1/4" (184mm)
sharp
6mm straight edge
curved blade
phenolic handle

PERIOSTEAL ELEVATOR



Phenolic handles
are autoclavable
to 290°F (143°C).

OM 46-0211
7 1/4" (184mm)
sharp
6mm straight edge
straight blade
phenolic handle

PERIOSTEAL ELEVATOR



Phenolic handles
are autoclavable
to 290°F (143°C).

OM 46-0212
7 1/4" (184mm)
sharp
6mm round edge
curved blade
phenolic handle

PERIOSTEAL ELEVATOR

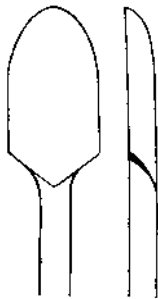

Phenolic handles are autoclavable to 290°F (143°C).

OM 46-0213
7 3/4" (195mm)
sharp
14mm oval edge
straight blade
phenolic handle

PERIOSTEAL ELEVATOR

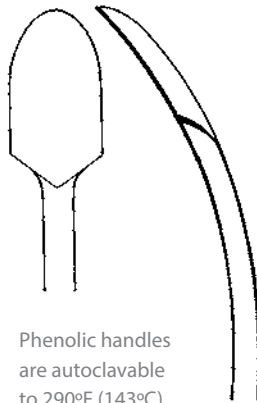

Phenolic handles are autoclavable to 290°F (143°C).

OM 46-0214
7 1/4" (184mm)
sharp
14mm oval edge
curved blade
phenolic handle

PERIOSTEAL ELEVATOR

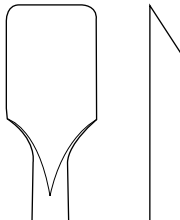

Phenolic handles are autoclavable to 290°F (143°C).

OM 46-0215
7 1/4" (184mm)
sharp
13mm straight edge
straight blade
phenolic handle

PERIOSTEAL ELEVATOR

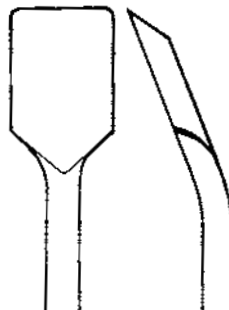

Phenolic handles are autoclavable to 290°F (143°C).

OM 46-0216
7 1/4" (184mm)
sharp
13mm straight edge
curved blade
phenolic handle

PERIOSTEAL ELEVATOR

ELEVATORS

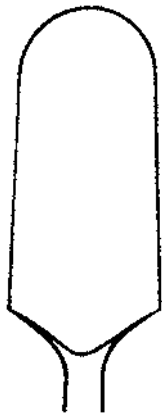

Phenolic handles are autoclavable to 290°F (143°C).

OM 46-0217
7 1/4" (184mm)
sharp
20mm round edge
straight blade
phenolic handle

PERIOSTEAL ELEVATOR

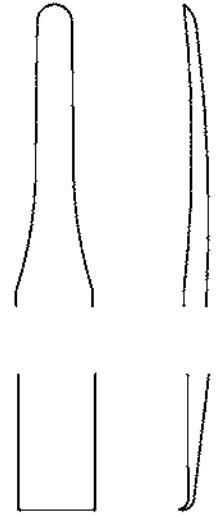

OM 55-0306
5 1/2" (140mm)
sharp
double ended
3mm round end and
10mm flat end

CARROLL PERIOSTEAL ELEVATOR

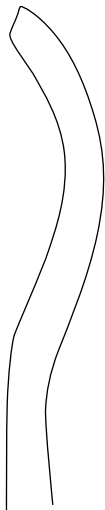

OM 69-0758
6 1/2" (165mm)
sharp
9mm

OM 69-0760
6 1/2" (165mm)
sharp
11mm

OM 69-0762
6 1/2" (165mm)
sharp
13mm

OM 69-0764
6 1/2" (165mm)
sharp
15mm

OM 69-0766
6 1/2" (165mm)
sharp
17mm

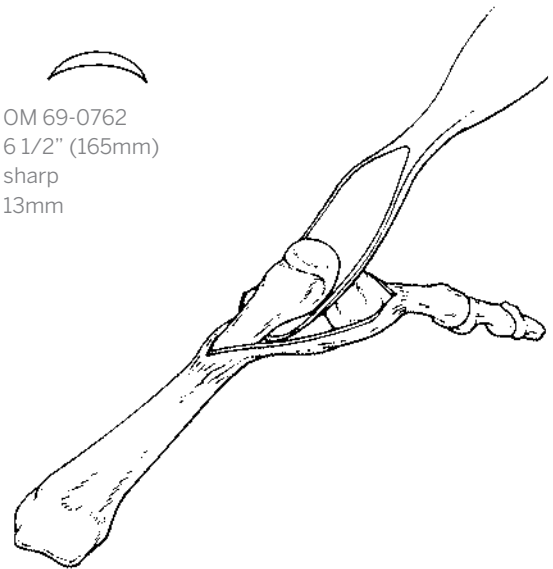

The McGlamry elevator is indispensable to deglove a metatarsal head. Also invaluable in numerous other procedures.

METATARSAL ELEVATOR

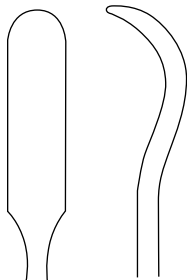

OM 46-0244
7 1/2" (191mm)
blunt
fully curved
width: 9/16" (15mm)

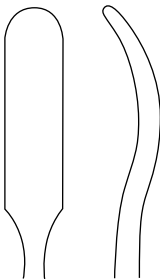

OM 46-0245
7 1/2" (191mm)
blunt
slightly curved
width: 9/16" (15mm)

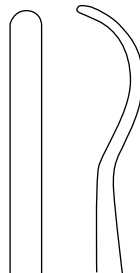

OM 46-0246
7 3/4" (185mm)
blunt
fully curved
width: 9/32" (7mm)

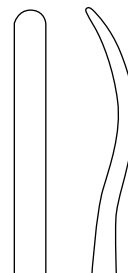

OM 46-0248
8" (203mm)
blunt
slightly curved
width: 9/32" (7mm)

CREGO PERIOSTEAL ELEVATOR

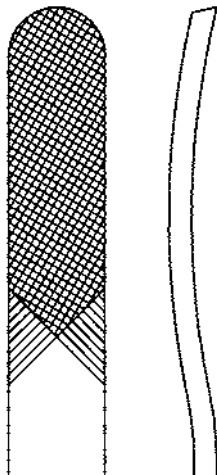

OM 46-0902

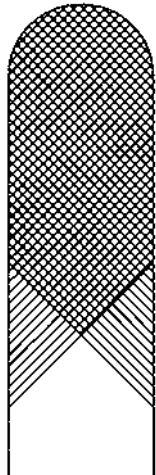

OM 46-0903

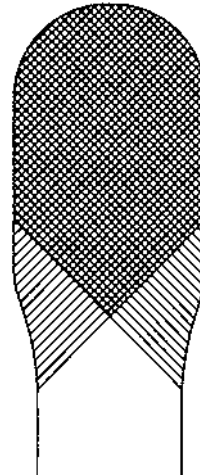

OM 46-0904

	width at tip	overall length	
OM 46-0901	3/8"	10 1/4" (260mm)	x-small
OM 46-0902	1/2"	10 1/4" (260mm)	small
OM 46-0903	3/4"	10 1/4" (260mm)	medium
OM 46-0905	1"	10 1/4" (260mm)	large
OM 46-0904	1"	13 3/4" (349mm)	x-large

DARRACH ELEVATOR
Blunt

Useful in shoulder surgery. Blunt tips with serrations can be used to elevate, or retract soft tissue and muscle from the operative site.



OM 46-0250

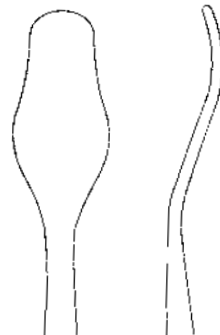

OM 46-0252

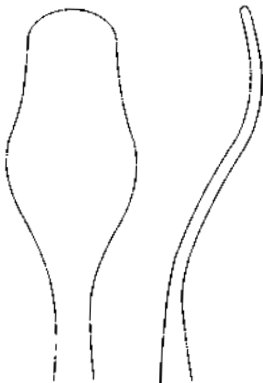

OM 46-0254

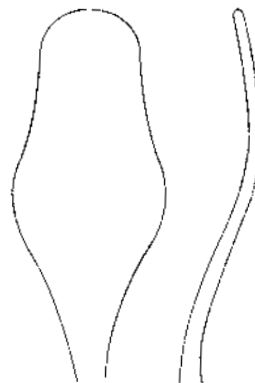

OM 46-0256

	width at tip	maximum width	overall length
OM 46-0250	8mm	13mm	7 1/2"
OM 46-0252	12mm	19mm	8"
OM 46-0254	17mm	25mm	9"
OM 46-0256	19mm	30mm	10"

CHANDLER ELEVATOR
Blunt



OM 49-0339
3/8" (10mm)



OM 49-0340
1/2" (13mm)



OM 49-0342
3/4" (19mm)

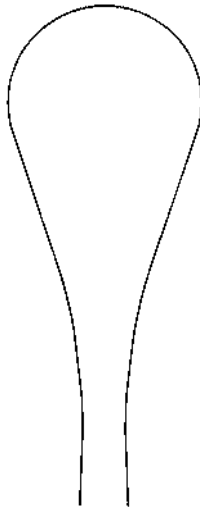

OM 49-0344
1" (25mm)

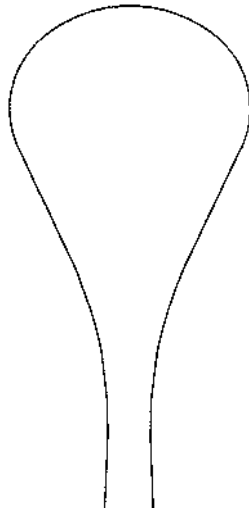

OM 49-0346
1 1/4" (32mm)

COBB SPINAL ELEVATOR

9 1/2" sharp
With hexagonal handle, all stainless steel

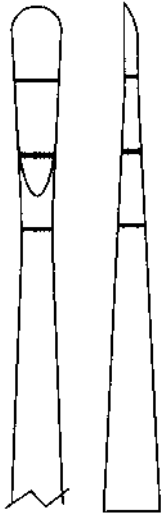
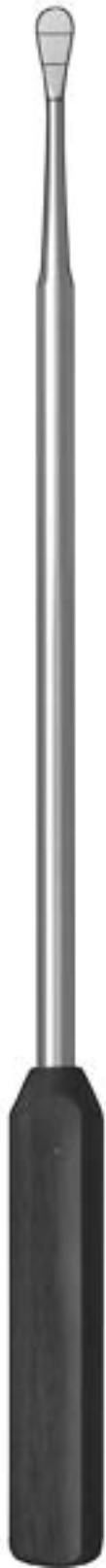

OM 55-0620
17" (432mm)
sharp
1/4" (6mm) tip width
2.7" tip length
9.3" shaft length
5" handle length
.285" (7.2mm) shaft diameter



OM 55-0610
20" (508mm)
sharp
1/4" (6mm) tip width
3 1/2" tip length
10" shaft length
6 1/2" handle length
.45" (11.5mm) shaft diameter



OM 55-0612
20" (508mm)
sharp
3/8" (10mm) tip width
3 1/2" tip length
10" shaft length
6 1/2" handle length
.45" (11.5mm) shaft diameter



OM 55-0614
20" (508mm)
sharp
.490" (13mm) tip width
3 1/2" tip length
10" shaft length
6 1/2" handle length
.45" (11.5mm) shaft diameter



OM 55-0798
12" (305mm) -
3/4" (19mm) Tip Width

COBB ELEVATOR
Endoscopic with phenolic handle

HARRINGTON SPINAL ELEVATOR

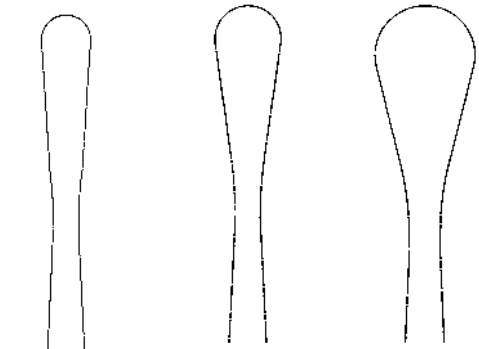

OM 90-0110 OM 90-0115 OM 90-0125

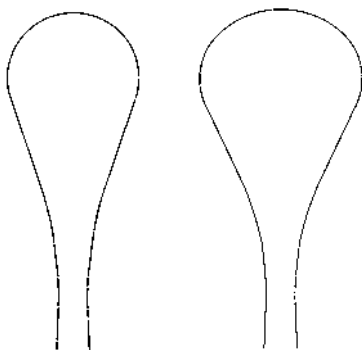

OM 90-0130 OM 90-0135

OM 90-0110 15" (381mm) overall with 9" (229mm) handle, 3/8" (10mm) width
OM 90-0115 15" (381mm) overall with 9" (229mm) handle, 1/2" (13mm) width
OM 90-0120 15" (381mm) overall with 9" (229mm) handle, 5/8" (16mm) width
OM 90-0125 15" (381mm) overall with 9" (229mm) handle, 3/4" (19mm) width
OM 90-0130 15" (381mm) overall with 9" (229mm) handle, 1" (25mm) width
OM 90-0135 15" (381mm) overall with 9" (229mm) handle, 1 1/4" (32mm) width

LONG COBB ELEVATOR
15" overall length with 9" handle



OM 90-0225
14" (360mm)

**LONG ELEVATOR
W/SILICONE HANDLE**
Endoscopic with silicone handle

1 3/8" wide (35mm)



OM 86-0132
12" (305mm)

FEMORAL HEAD ELEVATOR
with teeth



OM 46-0413S
3/8" (10mm)
all stainless steel

OM 46-0413
3/8" (10mm)
aluminum handle

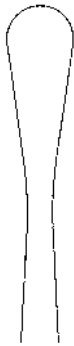

OM 46-0414S
1/2" (13mm)
all stainless steel

OM 46-0414
1/2" (13mm)
aluminum handle



OM 46-0416S
3/4" (19mm)
all stainless steel

OM 46-0416
3/4" (19mm)
aluminum handle



OM 46-0418S
1" (25mm)
all stainless steel

OM 46-0418
1" (25mm)
aluminum handle



OM 46-0420S
1 1/4" (32mm)
all stainless steel

OM 46-0420
1 1/4" (32mm)
aluminum handle

COBB SPINAL ELEVATOR
Endoscopic with handle

11" sharp all stainless steel. Also available with stainless steel working end and aluminum handle.

See Section AA for Cobb Rack.



OM 55-0300
10" (254mm) double ended
3mm semi-sharp end

**WOODSON ELEVATOR
AND SPATULA**



OM 55-0302
7" (178mm) double ended
with grooved blade
3mm blunt end

**WOODSON DURAL
SEPARATOR AND PACKER**

Phenolic handles are autoclavable to 290°F (143°C)

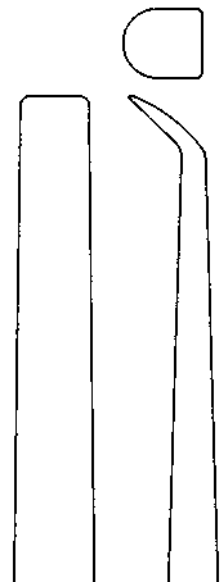

OM 55-0640
angled 45°

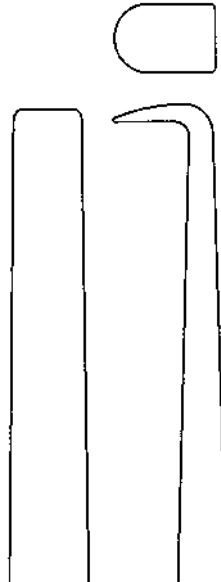

OM 55-0644
angled 90°

17" sharp with phenolic handle
9mm (432mm) radius tip
4" tip length
8" shaft length
5" handle length
.45" (11.5mm) shaft diameter

RIB ELEVATOR
Endoscopic



OM 55-0330
OM 55-0331
OM 55-0332



OM 55-0333



OM 55-0334



OM 55-0335
OM 55-0336
OM 55-0337



OM 55-0338



OM 55-0339



OM 55-0340



OM 55-0341

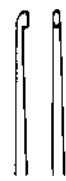

OM 55-0342
OM 55-0343



OM 55-0344



OM 55-0345
OM 55-0346



OM 55-0347
OM 55-0348

OM 55-0329	Container for Rhoton Set		
OM 55-0330	Round dissector	1mm	angled
OM 55-0331	Round dissector	2mm	angled
OM 55-0332	Round dissector	3mm	angled
OM 55-0333	Elevator curved		
OM 55-0334	Elevator angled		
OM 55-0335	Spatula dissector	#6 small	angled
OM 55-0336	Spatula dissector	#7 medium	angled
OM 55-0337	Spatula dissector	#8 large	angled
OM 55-0338	Hook 90°	sharp	angled
OM 55-0339	Hook 90°	blunt	angled
OM 55-0340	Hook 45°	sharp	angled
OM 55-0341	Needle	sharp	straight
OM 55-0342	Micro curette	1X2mm	straight
OM 55-0343	Micro curette	1X2mm	angled
OM 55-0344	Ball tipped dissector	0.8mm	
OM 55-0345	Ball tipped dissector	3mm	90°
OM 55-0346	Ball tipped dissector	5mm	90°
OM 55-0347	Ball tipped dissector	4mm	40°
OM 55-0348	Ball tipped dissector	8mm	40°

Titanium 7 1/2" (191mm)

OM 97-0260	Dissector titanium	1mm	blade round
OM 97-0261	Dissector titanium	2mm	blade round
OM 97-0262	Dissector titanium	3mm	blade round
OM 97-0263	Elevator titanium		curved
OM 97-0264	Elevator titanium		angled
OM 97-0265	Spatula dissector titanium		small
OM 97-0266	Spatula dissector titanium		medium
OM 97-0267	Spatula dissector titanium		large
OM 97-0268	Hook/needle titanium	90deg	semi-sharp
OM 97-0269	Hook/needle titanium	90deg	blunt
OM 97-0270	Hook/needle titanium	45deg	semi-sharp
OM 97-0271	Hook/needle titanium		straight
OM 97-0272	Curette titanium		straight
OM 97-0273	Curette titanium		angled
OM 97-0274	Ball-dissector titanium	90deg	3mm
OM 97-0276	Ball-dissector titanium		straight
OM 97-0277	Ball-dissector titanium	90deg	5mm
OM 97-0278	Ball-dissector titanium	40deg	4mm
OM 97-0279	Ball-dissector titanium	40deg	8mm

RHOTON MICRO DISSECTION INSTRUMENTS

7 1/2" (191mm)

ELEVATORS

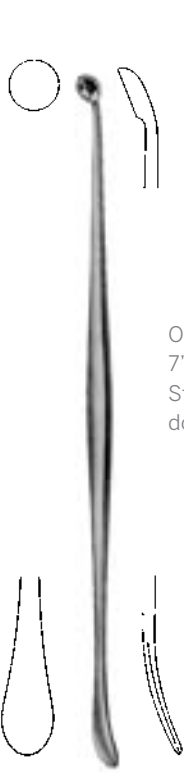

OM 57-0624
7" (178mm)
Style 1
double ended

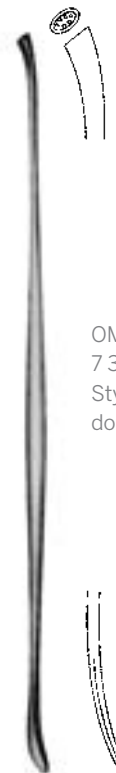

OM 57-0626
7 3/4" (195mm)
Style 2
double ended

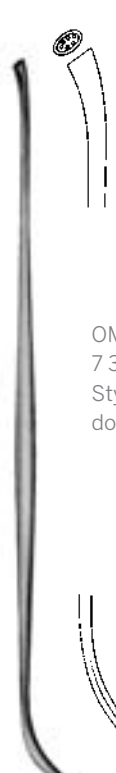

OM 57-0628
7 3/4" (195mm)
Style 3
double ended



OM 57-0630
8" (203mm)
Style 4
single ended



OM 57-0632
11 1/2" (292mm)
Style 5
double ended

PENFIELD ELEVATOR



OM 46-0916
9 1/4" (235mm)
phenolic handle

Phenolic handles
are autoclavable
to 290°F (143°C)

**SHOULDER
PENETRATING AWL**

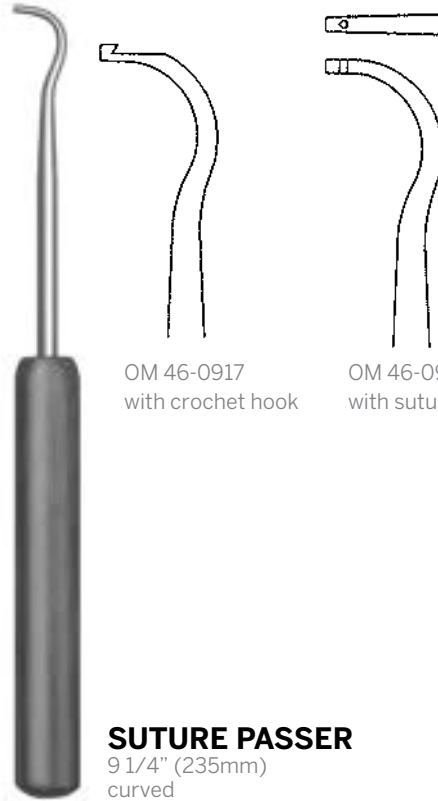

OM 46-0917
with crochet hook

OM 46-0918
with suture hole

Used to pass sutures in
shoulder surgery.

Phenolic handles are
autoclavable to 290°F
(143°C)

SUTURE PASSER
9 1/4" (235mm)
curved

OM 48-0336
6 1/4" (159mm)
square taper



BONE AWL



OM 48-0337
8 1/4" (210mm)

PERTHES BONE AWL



For penetrating
cortex of bone. Used
as grooved director
for insertion of pins.

OM 48-0338	7 1/2"	working end	2.5mm dm
OM 48-0339	8 1/4"	working end	3mm dm
OM 48-0340	8 1/2"	working end	5mm dm
OM 48-0341	10 1/2"	working end	6mm dm

RUSH AWL AND REAMER



OM 48-0303
11" (280mm)
with handle

**KUNTSCHER DIAMOND
POINTED AWL**



OM 48-0588

BONE HOOK STOUT 6"



OM 46-0913
small



OM 46-0914
medium

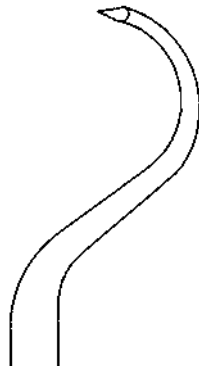

OM 46-0915
large

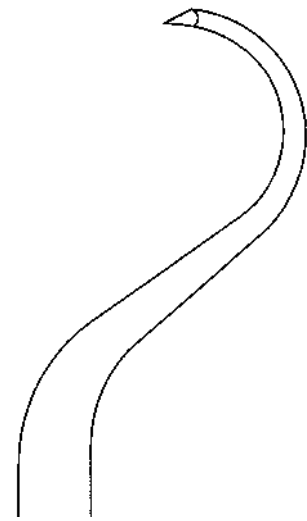

SHOULDER PERCUSSION AWL
8 1/2" (220mm)

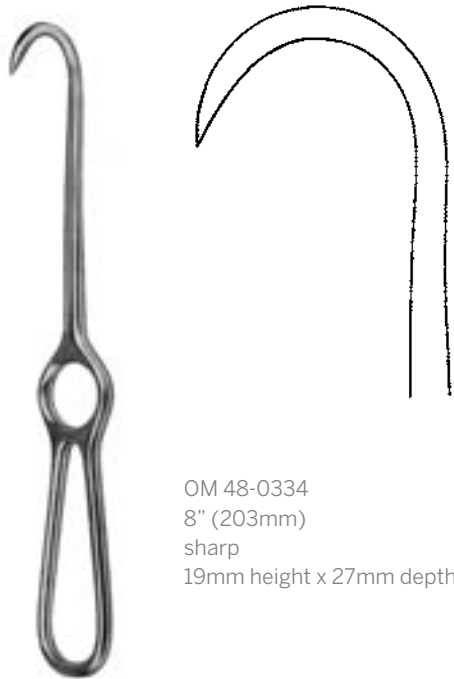

OM 48-0334
8" (203mm)
sharp
19mm height x 27mm depth

VOLKMAN BONE HOOK



OM 48-0333
9" (229mm)
blunt
15mm height x 20mm depth

VOLKMAN BONE HOOK

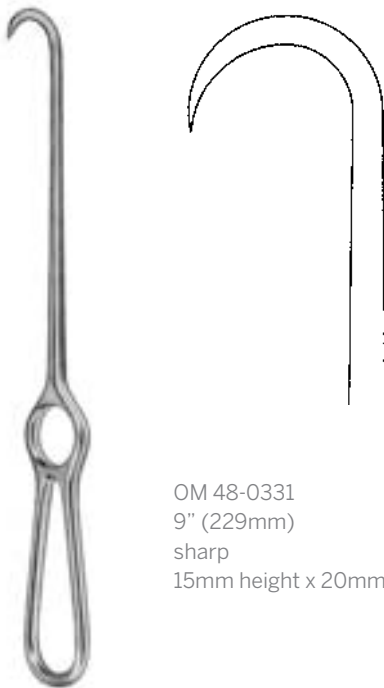

OM 48-0331
9" (229mm)
sharp
15mm height x 20mm depth

VOLKMAN BONE HOOK



OM 48-0335
9 3/4" (248mm)
sharp
15mm height x 20mm depth

VOLKMAN BONE HOOK

BONE HOOKS



OM 48-0342

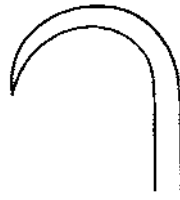

OM 48-0343

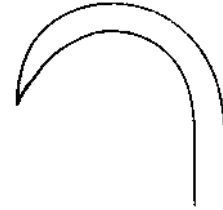

OM 48-0344

OM 48-0342
9" (229mm)
small 6mm height x 10mm depth

OM 48-0343
9" (229mm)
medium 11mm height x 18mm depth

OM 48-0344
9" (229mm)
large 12mm height x 21mm depth

BONE HOOK

Sharp with grip handle

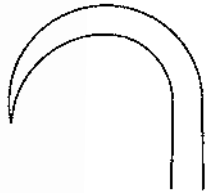

OM 48-0332
7" (178mm)
large, for femurs
18mm height x 21mm depth



OM 48-0345
10 1/2" (280mm)

BONE HOOK

Sharp with T-handle

SELF TAPPING FEMORAL HEAD REMOVER



OM 48-0583

LONG BONE HOOK
Blunt W/t-handle 10" Large



OM 48-0580 Large
10" (254mm)
10mm height x 40mm depth

LONG BONE HOOK
Sharp with Phenolic Handle

BONE CURETTES



SECTION H



To scrape, shape and clean bone.

CONTENTS

Bone Curettes	1-6
Endoscopic Bone Curettes	7-8
Long Bone Curettes	9-10
Micro Curettes	11-12



OM 29-0632
6" (152mm)
double ended
oval cups

JANSEN CURETTE



OM 29-0620
5 1/2" (140mm)
double ended
4mm and 5mm round cups

MARTINI BONE CURETTE



OM 29-0630
5 1/2" (140mm)
double ended
3mm and 4mm oval cups

WILLIGER BONE CURETTE

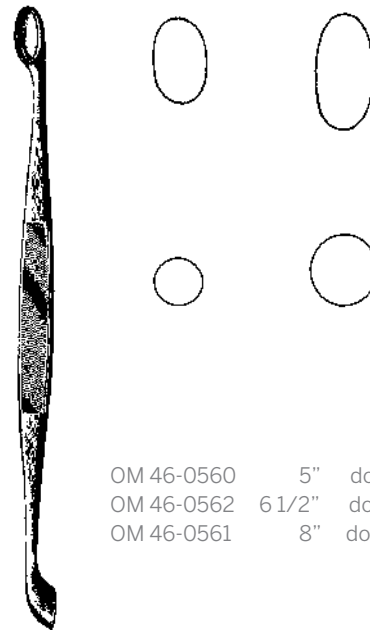

OM 46-0560 5" double ended
OM 46-0562 6 1/2" double ended
OM 46-0561 8" double ended

VOLKMANN CURETTE
Oval and round cups

BONE AWLS

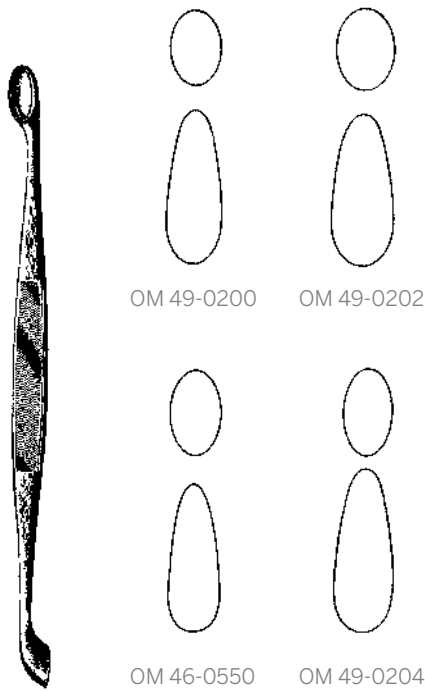

OM 49-0200 OM 49-0202

OM 46-0550 OM 49-0204

OM 49-0200 5" (127mm)
 OM 49-0202 5 1/2" (140mm)
 OM 46-0550 6 1/2" (165mm)
 OM 49-0204 8" (203mm)

VOLKMANN CURETTE

Oval cups, double ended

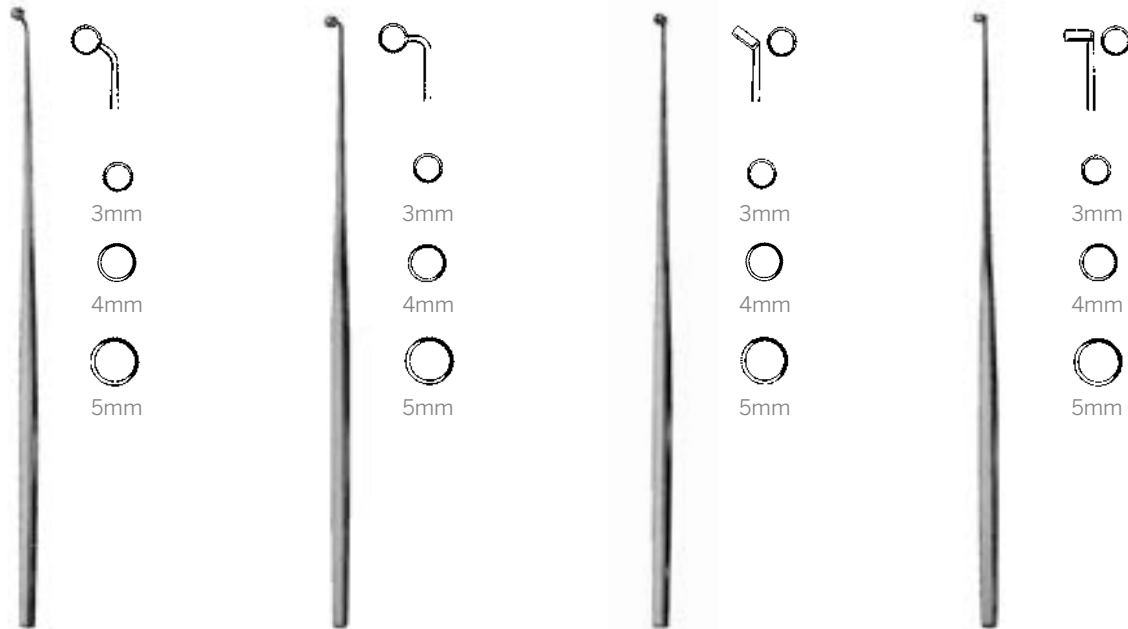

Vertical angle 45°
 OM 49-0403 3mm diameter
 OM 49-0404 4mm diameter
 OM 49-0405 5mm diameter

Vertical angle 90°
 OM 49-0413 3mm diameter
 OM 49-0414 4mm diameter
 OM 49-0415 5mm diameter

Horizontal angle 45°
 OM 49-0423 3mm diameter
 OM 49-0424 4mm diameter
 OM 49-0425 5mm diameter

Horizontal angle 90°
 OM 49-0433 3mm diameter
 OM 49-0434 4mm diameter
 OM 49-0435 5mm diameter

RAY PITUITARY CURETTES

7 1/2"



OM 49-0580 8" (203mm) #000
 OM 49-0582 8" (203mm) #00
 OM 49-0584 8" (203mm) #0

EPSTEIN CURETTE
 With hollow handle



OM 49-0574 straight
 OM 49-0576 down angle
 OM 49-0578 up angle

SCOVILLE CURETTE
 With hollow handle
 10" (254mm)

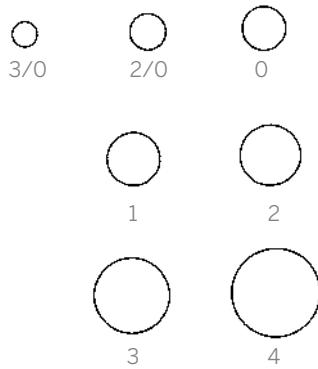

6 3/4" (172mm) straight
 OM 49-0120 #3/0
 OM 49-0121 #2/0
 OM 49-0122 #0
 OM 49-0123 #1
 OM 49-0124 #2
 OM 49-0125 #3
 OM 49-0126 #4



6 3/4" (172mm) angled 45°
 OM 49-0120A #3/0
 OM 49-0121A #2/0
 OM 49-0122A #0
 OM 49-0123A #1
 OM 49-0124A #2
 OM 49-0125A #3
 OM 49-0126A #4

BRUN (SPRATT) CURETTE
 With hollow handle, round cup

BONE CURETTES

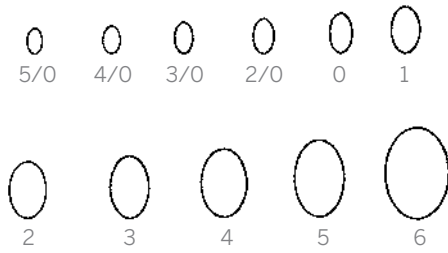

7" (178mm) straight	7" (178mm) angled 45°	9" (229mm) straight	9" (229mm) angled 45°
OM 46-0511 #5/0	OM 46-0511A #5/0	OM 46-0563 #3/0	OM 49-0009 #4/0
OM 46-0512 #4/0	OM 46-0512A #4/0	OM 46-0564 #2/0	OM 49-0110 #3/0
OM 46-0513 #3/0	OM 46-0513A #3/0	OM 46-0565 #0	OM 49-0111 #2/0
OM 46-0515 #2/0	OM 46-0515A #2/0	OM 46-0566 #1	OM 49-0112 #0
OM 46-0517 #0	OM 46-0517A #0	OM 46-0567 #2	OM 49-0113 #1
OM 46-0519 #1	OM 46-0519A #1	OM 46-0568 #3	OM 49-0114 #2
OM 46-0521 #2	OM 46-0521A #2	OM 46-0569 #4	OM 49-0115 #3
OM 46-0523 #3	OM 46-0523A #3	OM 46-0570 #5	OM 49-0116 #4
OM 46-0525 #4	OM 46-0525A #4	OM 46-0571 #6	OM 49-0117 #5
OM 46-0529 #5	OM 46-0529A #5		OM 49-0118 #6
OM 46-0531 #6	OM 46-0531A #6		

BRUN (SPRATT) CURETTE

With hollow handle, oval cup

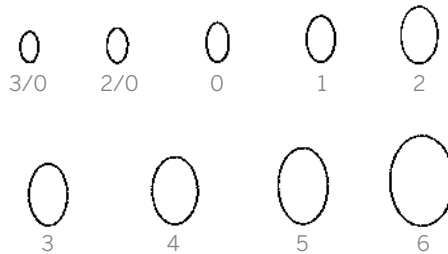

Straight	Angled 45°
OM 46-0551 #3/0	OM 49-0150 #3/0
OM 46-0552 #2/0	OM 49-0151 #2/0
OM 46-0553 #0	OM 49-0152 #0
OM 46-0554 #1	OM 49-0153 #1
OM 46-0555 #2	OM 49-0154 #2
OM 46-0556 #3	OM 49-0155 #3
OM 46-0557 #4	OM 49-0156 #4
OM 46-0558 #5	OM 49-0157 #5
OM 46-0559 #6	OM 49-0158 #6

BRUN CURETTE

9" (229mm) with solid hexagonal handle



Anodized aluminum handle
stainless steel, working end

All stainless.

Straight

- OM 46-0422 #3/0
- OM 46-0423 #2/0
- OM 46-0424 #0
- OM 46-0425 #1
- OM 46-0426 #2
- OM 46-0427 #3
- OM 46-0428 #4
- OM 46-0429 #5
- OM 46-0430 #6

Angled

- OM 46-0433 #3/0
- OM 46-0434 #2/0
- OM 46-0435 #0
- OM 46-0436 #1
- OM 46-0437 #2
- OM 46-0438 #3
- OM 46-0439 #4
- OM 46-0440 #5
- OM 46-0441 #6

Straight

- OM 46-0422S #3/0
- OM 46-0423S #2/0
- OM 46-0424S #0
- OM 46-0425S #1
- OM 46-0426S #2
- OM 46-0427S #3
- OM 46-0428S #4
- OM 46-0429S #5
- OM 46-0430S #6

Angled

- OM 46-0433S #3/0
- OM 46-0434S #2/0
- OM 46-0435S #0
- OM 46-0436S #1
- OM 46-0437S #2
- OM 46-0438S #3
- OM 46-0439S #4
- OM 46-0440S #5
- OM 46-0441S #6

COBB CURETTE

11" (280mm) with knurled handle

See Section AA for Cobb Rack



- OM PS03.959-0 Cobb Curette 11 1/4" Straight #0
- OM PS03.959-00 Cobb Curette 11 1/4" Straight #00
- OM PS03.959-000 Cobb Curette 11 1/4" Straight #000
- OM PS03.959-1 Cobb Curette 11 1/4" Straight #1
- OM PS03.959-2 Cobb Curette 11 1/4" Straight #2
- OM PS03.959-3 Cobb Curette 11 1/4" Straight #3
- OM PS03.959-4 Cobb Curette 11 1/4" Straight #4
- OM PS03.959-5 Cobb Curette 11 1/4" Straight #5
- OM PS03.959-6 Cobb Curette 11 1/4" Straight #6

SUNY UPSTATE CURETTE

11 1/4" (286mm)



Silicone handles are available in assorted colors per request.

OM W45-234
Sharp, serrated with black silicone handle left

OM W45-235
Sharp, serrated with black silicone handle right

OM W45-233
Sharp, serrated with black silicone handle straight

CURETTE #8

BONE CURETTES



Straight

OM 49-0450 size #1, 8mm diameter
 OM 49-0452 size #2, 6mm diameter
 OM 49-0454 size #3, 3mm diameter

Angled 35°

OM 49-0456 size #1, 8mm diameter
 OM 49-0458 size #2, 6mm diameter
 OM 49-0460 size #3, 3mm diameter

CONE RING CURETTE

9" (229mm) with knurled handle with fenestrated cup



OM 55-0680 10" (250mm)
 OM 55-0684 11 1/2" (292mm)



OM 55-0681 10" (250mm)
 OM 55-0685 11 1/2" (292mm)



OM 55-0682 10 1/4" (260mm)
 OM 55-0686 12" (305mm)

RING CURETTE

Hollow handle with fenestrated cup



OM 29-0503



OM 29-0505



OM 29-0507



OM 29-0495 1mm
 OM 29-0496 2mm
 OM 29-0497 3mm
 OM 29-0498 4mm
 OM 29-0499 5mm
 OM 29-0500 6mm

PIFFARD CURETTE

5 1/2" (140mm)



FOX CURETTE

5 1/2" (140mm) round

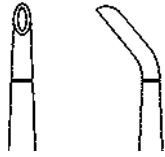

OM 55-0532 17" (432mm)
 40° angle
 2mm x 4mm cup
 2.7" tip length
 9.3" shaft length
 5" handle length
 .285" (7.2mm) shaft diameter

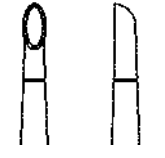

OM 55-0523 17" (432mm)
 straight
 3mm x 6mm cup
 2.7" tip length
 9.3" shaft length
 5" handle length
 .285" (7.2mm) shaft diameter

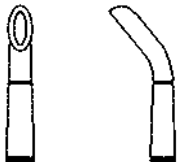

OM 55-0533 17" (432mm)
 40° angle
 3mm x 6mm cup
 2.7" tip length
 9.3" shaft length
 5" handle length
 .285" (7.2mm) shaft diameter

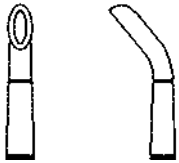

OM 55-0543 20" (508mm)
 40° angle
 3mm x 6mm cup
 3.5" tip length
 10" shaft length
 6.5" handle length
 .45" (11.5mm) shaft diameter

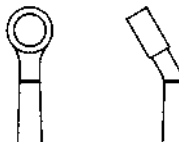

OM 55-0556 20" (508mm)
 30° angle
 6mm x 9mm cup
 3.5" tip length
 10" shaft length
 6.5" handle length
 .45" (11.5mm) shaft diameter

Phenolic handles are autoclavable to 290°F (143°C).



ENDOSCOPIC BRUN CURETTE
 Graduated with phenolic handle

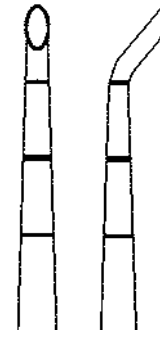

OM 55-0593 17" (432mm)
 reverse 40° angle
 3mm x 6mm cup
 2.7" tip length
 9.3" shaft length
 5" handle length
 .285" (7.2mm) shaft diameter

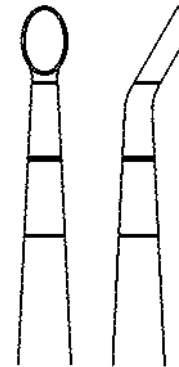

OM 55-0586 20" (508mm)
 reverse 30° angle
 6mm x 9mm cup
 3.5" tip length
 10" shaft length
 6.5" handle length
 .45" (11.5mm) shaft diameter

Phenolic handles are autoclavable to 290°F (143°C).



ENDOSCOPIC EPSTEIN CURETTE
 Graduated with phenolic handle

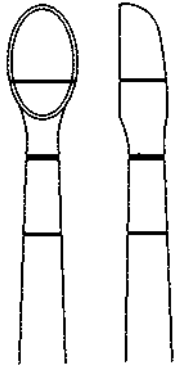

OM 55-0510 20" (508mm)
straight
9mm x 15mm cup
3.5" tip length
10" shaft length
6.5" handle length
.45" (11.5mm) shaft diameter

Phenolic handles are autoclavable to 290°F (143°C).

ENDOSCOPIC SCOVILLE CURETTE
With phenolic handle

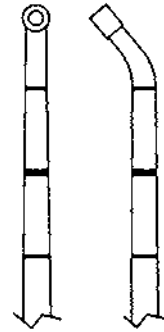

OM 55-0573 17" (432mm)
40° angle
3mm cup diameter
2.7" tip length
9.3" shaft length
5" handle length
.285" (7.2mm) shaft diameter

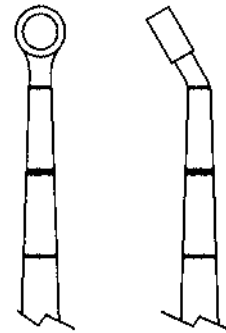

OM 55-0566 20" (508mm)
30° angle
6mm cup diameter
3.5" tip length
10" shaft length
6.5" handle length
.45" (11.5mm) shaft diameter

Phenolic handles are autoclavable to 290°F (143°C).

ENDOSCOPIC CONE RING CURETTE
With phenolic handle



Straight 15" (381mm)

- OM PS00 991-01 #4/0
- OM PS00 991-02 #3/0
- OM PS00 991-03 #2/0
- OM PS00 991-04 #0
- OM PS00 991-05 #1
- OM PS00 991-06 #2
- OM PS00 991-07 #3
- OM PS00 991-08 #4
- OM PS00 991-09 #5
- OM PS00 991-10 #6

Angled 15" (381mm)

- OM PS00 991-01A #4/0
- OM PS00 991-02A #3/0
- OM PS00 991-03A #2/0
- OM PS00 991-04A #0
- OM PS00 991-05A #1
- OM PS00 991-06A #2
- OM PS00 991-07A #3
- OM PS00 991-08A #4
- OM PS00 991-09A #5
- OM PS00 991-10A #6

LONG BONE CURETTE



Straight 15" (381mm)

- OM 55-0576 (10mm X 19mm cup)
- OM 55-0577 (13mm X 25mm cup)
- OM 55-0578 (15mm X 29mm cup)

VOLKMANN CURETTE

BONE CURETTES

Straight

OM 93-0112 15" (381mm) overall, #3/0
OM 93-0113 15" (381mm) overall, #2/0
OM 93-0114 15" (381mm) overall, #0
OM 93-0115 15" (381mm) overall, #1
OM 93-0116 15" (381mm) overall, #2
OM 93-0117 15" (381mm) overall, #3
OM 93-0118 15" (381mm) overall, #4
OM 93-0119 15" (381mm) overall, #5
OM 93-0125 15" (381mm) overall, #6
OM 93-0127 15" (381mm) overall, #7



LONG COBB CURETTE
15" overall length with 9" handle

Angled

OM 93-0205 15" (381mm) overall, #3/0
OM 93-0206 15" (381mm) overall, #2/0
OM 93-0207 15" (381mm) overall, #0
OM 93-0208 15" (381mm) overall, #1
OM 93-0209 15" (381mm) overall, #2
OM 93-0210 15" (381mm) overall, #3
OM 93-0211 15" (381mm) overall, #4
OM 93-0212 15" (381mm) overall, #5
OM 93-0213 15" (381mm) overall, #6
OM 93-0214 15" (381mm) overall, #7



OM RD 11-1142 size 6
OM RD 11-1143 size 8
OM RD 11-1144 size 10
OM RD 11-1145 size 12
OM RD 11-1146 size 15
OM RD 11-1147 size 18

MCELROY CURETTE
14" (355mm) stainless steel

CERVICAL MICRO CURETTE

Forward Straight

OM 99-0001 #0
 OM 99-0002 #00
 OM 99-0003 #000
 OM 99-0004 #0000
 OM 99-0005 Bone Cutter #00

Forward Angled

OM 99-0006 #0
 OM 99-0007 #00
 OM 99-0008 #000
 OM 99-0009 #0000
 OM 99-0010 Bone Cutter #00

Backward Straight

OM 99-0011 #0
 OM 99-0012 #00
 OM 99-0013 #000
 OM 99-0014 #0000
 OM 99-0015 Bone Cutter #00

Backward Angle

OM 99-0016 #0
 OM 99-0017 #00
 OM 99-0018 #000
 OM 99-0019 #0000
 OM 99-0020 Bone Cutter #00

OM 99-0021 Cervical Micro Nerve Hook
 OM 99-0022 Cervical Ultra-Micro Nerve Hook
 OM 99-0023 Cervical Micro Waxer
 OM 99-0024 Cervical Micro Knife Handle

XL CERVICAL MICRO CURETTE

Forward Straight

OM 99-0030 #0
 OM 99-0031 #00
 OM 99-0032 #000
 OM 99-0033 #0000
 OM 99-0034 Bone Cutter

Forward Angled

OM 99-0035 #0
 OM 99-0036 #00
 OM 99-0037 #000
 OM 99-0038 #0000
 OM 99-0039 Bone Cutter

Backward Straight

OM 99-0040 #0
 OM 99-0041 #00
 OM 99-0042 #000
 OM 99-0043 #0000
 OM 99-0044 Bone Cutter

Backward Angle

OM 99-0045 #0
 OM 99-0046 #00
 OM 99-0047 #000
 OM 99-0048 #0000
 OM 99-0049 Bone Cutter

OM 99-0050 XL Cervical Micro Nerve Hook
 OM 99-0051 XL Cervical Ultra-Micro Nerve Hook
 OM 99-0052 Cervical Micro Waxer
 OM 99-0053 Cervical Micro Knife Handle



LUMBAR MICRO CURETTE

Forward Straight

OM 99-0060 #0
 OM 99-0061 #1
 OM 99-0062 #2

Forward Angled

OM 99-0063 #0
 OM 99-0064 #1
 OM 99-0065 #2

Forward Down

OM 99-0066 #0
 OM 99-0067 #1
 OM 99-0068 #2

Backward Straight

OM 99-0069 #0
 OM 99-0070 #1
 OM 99-0071 #2

MICRO CURETTES

OM 99-0300	Sterilizing Tray with Silicone Holders for micro curettes		
OM 99-0301	Microsect curette	25.9cm Fig. 1	forward angle
OM 99-0302	Microsect curette	25.9cm Fig. 1	backward angle
OM 99-0303	Microsect curette	25.9cm Fig. 2	forward angle
OM 99-0304	Microsect curette	25.9cm Fig. 2	backward angle
OM 99-0305	Microsect curette	25.9cm Fig. 3	forward angle
OM 99-0306	Microsect curette	25.9cm Fig. 3	backward angle
OM 99-0307	Microsect curette	25.9cm Fig. 4	forward angle
OM 99-0308	Microsect curette	25.9cm Fig. 4	backward angle
OM 99-0309	Microsect curette	25.9cm Fig. 5	forward angle
OM 99-0310	Microsect curette	25.9cm Fig. 5	backward angle
OM 99-0311	Bray End Dissector	29.5cm	5mm
OM 99-0312	Bray End Dissector	29.5cm	3mm



MICRO CURETTES

SKIN HOOKS AND RETRACTORS



SECTION I



To retract, secure and apply traction to soft tissue and bone. To provide visualization and maintain wound exposure.

CONTENTS

Skin Hooks	1-2
Finger Retractors	3-4
Retractors	5-17
Hip Retractors	18
Shoulder Retractors	19-26
Knee Retractors	26-27
Hohmann Retractors	28-32
Vickers Retractors	33
Self Retaining Retractors	34-52
Fiberoptic Retractors	53-54
Multi Trac Retractors	55-58
Femoral Spreaders	59-60
McCulloch Retractor	61-62

ORTHO+MED
The Surgical Instrument Specialists



OM 52-0055
4 3/4" (121mm)
one sharp prong
2mm diameter

**ORTHOMED
SKIN HOOK**

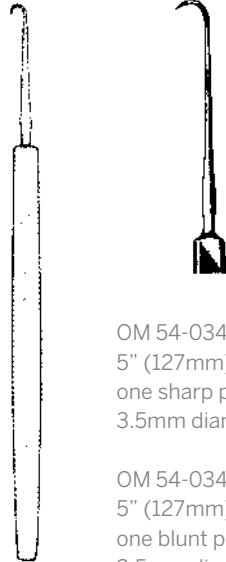

OM 54-0346
5" (127mm)
one sharp prong
3.5mm diameter

OM 54-0348
5" (127mm)
one blunt prong
3.5mm diameter

WIENER SKIN HOOK



OM 52-0050
5 1/2" (140mm)
one sharp prong
large deep curve
4mm diameter

COTTLE SKIN HOOK



OM 48-0158 ?
OM 48-0161 ?

OM 48-0158
5" (127mm)
one sharp prong
2.5mm diameter

OM 48-0161
5" (127mm)
one blunt prong
2.5mm diameter

FRAZIER HOOK



OM 54-0338 ?
OM 54-0342 ?

OM 54-0338
5" (127mm)
one sharp prong
1.5mm diameter

OM 54-0342
5" (127mm)
one blunt prong
1.5mm diameter

TYRELL HOOK



OM 54-0350
5" (127mm)
two sharp prongs
2.5mm wide

GUTHRIE HOOK

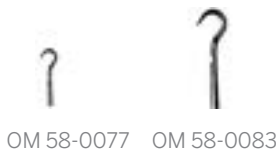

OM 58-0077
7" (178mm)
2mm diameter

OM 58-0083
7" (178mm)
3mm diameter

GILLIES HOOK



OM 52-0040
6" (152mm)
two sharp prongs
2.5mm wide

OM 52-0042
6" (152mm)
two blunt prongs
2.5mm wide

FREER SKIN HOOK

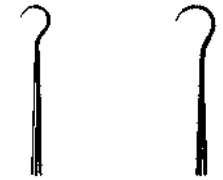

OM 52-0060 OM 52-0064

OM 52-0060 3mm diameter
OM 52-0064 5mm diameter
OM 52-0068 7mm diameter

KLEINERT-KUTZ HOOK
6" (152mm)

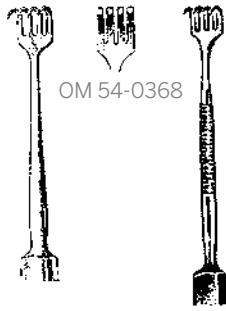

OM 54-0366 OM 54-0372

OM 54-0366 4 sharp prongs, rigid
OM 54-0368 4 blunt prongs, rigid
OM 54-0372 4 sharp prongs, flexible

BLAIR (ROLLET) RETRACTOR
5 1/2" (140mm) 6mm wide



OM 58-0091 OM 58-0092

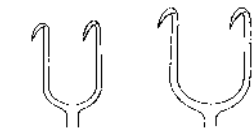

OM 58-0093 OM 58-0094

OM 58-0088 1 prong
OM 58-0091 2 prongs 2mm wide
OM 58-0092 2 prongs 5mm wide
OM 58-0093 2 prongs 7mm wide
OM 58-0094 2 prongs 10mm wide

JOSEPH HOOK
6 1/4" (159mm) sharp



OM 52-0156



OM 52-0158



OM 52-0162

- OM 52-0156 1 sharp prong
- OM 52-0158 2 sharp prongs
- OM 52-0162 3 sharp prongs
- OM 52-0164 1 blunt prong
- OM 52-0166 2 blunt prongs
- OM 52-0172 3 blunt prongs

RIGID RAKE RETRACTOR

6 1/2" (165mm)



OM 52-0174



OM 52-0176



OM 52-0182

- OM 52-0174 1 sharp prong
- OM 52-0176 2 sharp prongs
- OM 52-0182 3 sharp prongs
- OM 52-0184 1 blunt prong
- OM 52-0188 2 blunt prongs
- OM 52-0192 3 blunt prongs

FLEXIBLE RAKE RETRACTOR

6 1/4" (159mm)



OM 52-0082



OM 52-0086



OM 52-0087

- OM 52-0082 1 sharp prong
- OM 52-0086 2 sharp prongs
- OM 52-0087 3 sharp prongs

LAHEY RETRACTOR

4 3/4" (121mm)



OM 52-0198



OM 52-0202



OM 52-0208



OM 52-0212



OM 52-0204



OM 52-0206



OM 52-0214



OM 52-0216

- OM 52-0198 2 sharp prongs
- OM 52-0202 3 sharp prongs
- OM 52-0204 4 sharp prongs
- OM 52-0206 6 sharp prongs
- OM 52-0208 2 blunt prongs
- OM 52-0212 3 blunt prongs
- OM 52-0214 4 blunt prongs
- OM 52-0216 6 blunt prongs

VOLKMAN RETRACTOR

4 1/2" (114mm)



OM 54-0358



OM 54-0360



OM 54-0362

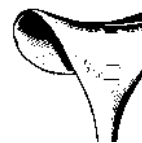

OM 54-0364

- OM 54-0358 #1 12mm width X 10mm depth
- OM 52-0360 #2 13mm width X 10mm depth
- OM 52-0362 #3 15mm width X 10mm depth
- OM 52-0364 #4 17mm width X 10mm depth

DESMARRES RETRACTOR

5 1/2" (140mm)

FINGER RETRACTORS

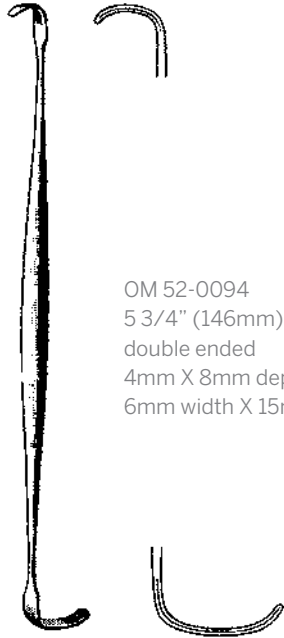

OM 52-0094
5 3/4" (146mm)
double ended
4mm X 8mm depth blade and
6mm width X 15mm depth blade

RAGNELL RETRACTOR

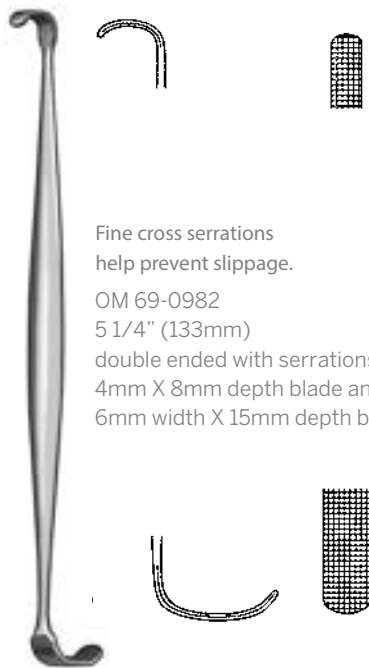

Fine cross serrations
help prevent slippage.
OM 69-0982
5 1/4" (133mm)
double ended with serrations
4mm X 8mm depth blade and
6mm width X 15mm depth blade

**RAGNELL-LINDE
RETRACTOR**



OM 52-0076
6" (152mm)
double ended
6mm X 17mm depth blade and
9mm width X 20mm depth blade

DAVIS RETRACTOR

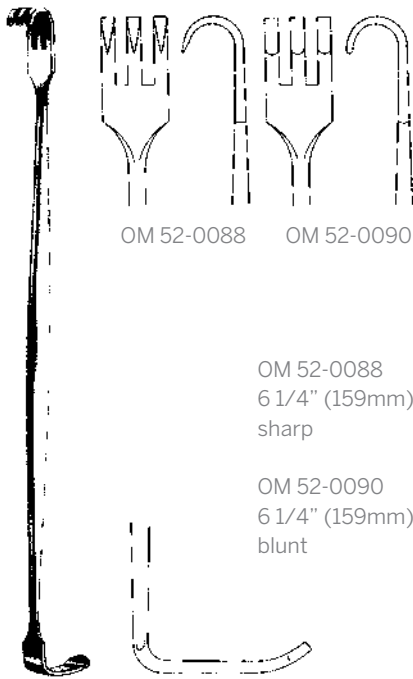

OM 52-0088 OM 52-0090

OM 52-0088
6 1/4" (159mm)
sharp

OM 52-0090
6 1/4" (159mm)
blunt

SENN RETRACTOR

3 prongs

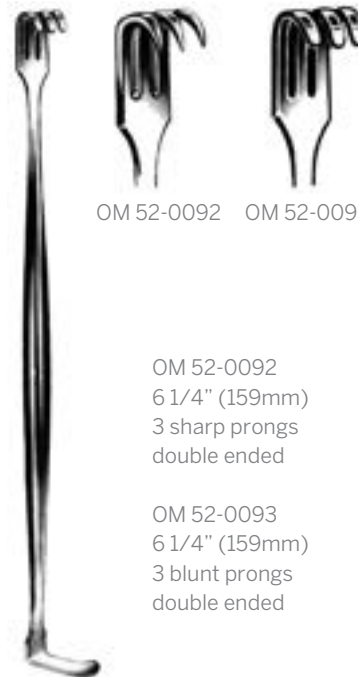

OM 52-0092 OM 52-0093

OM 52-0092
6 1/4" (159mm)
3 sharp prongs
double ended

OM 52-0093
6 1/4" (159mm)
3 blunt prongs
double ended

MATHIEU RETRACTOR

9mm width X 7mm depth prongs
and 7mm width X 18mm depth blade

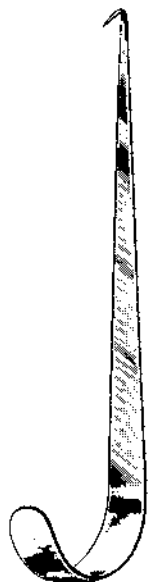

OM 52-0096
5 3/4" (146mm)
sharp

JACKSON TRACHEAL HOOK

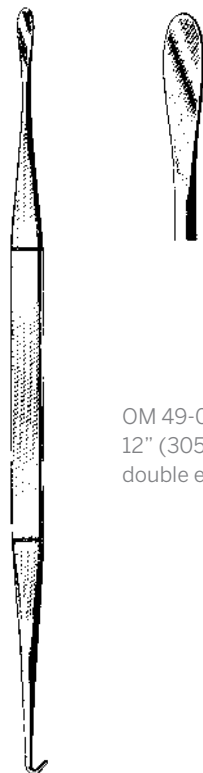

OM 49-0320
12" (305mm)
double ended

SMITHWICK HOOK AND DISSECTOR



OM 51-0468
4 3/8" (111mm)
double ended

CRILE RETRACTOR



OM 52-0116
#1



OM 52-0118
#2



OM 52-0122
#3



OM 52-0124
#4



OM 52-0128
#5



OM 52-0130
#6

MEYERDING FINGER RETRACTOR
7" (178mm)

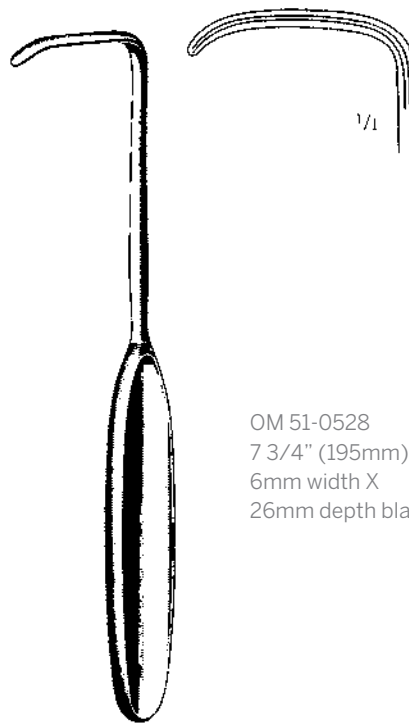

OM 51-0528
7 3/4" (195mm)
6mm width X
26mm depth blade

LAHEY RETRACTOR

RETRACTORS

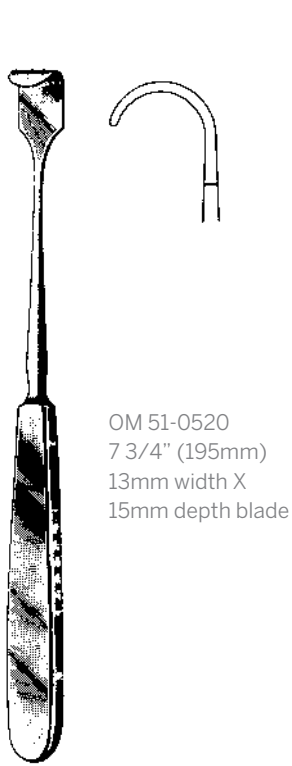

OM 51-0520
7 3/4" (195mm)
13mm width X
15mm depth blade

LITTLE RETRACTOR



OM 51-0524
8 1/2" (216mm)
fenestrated handle
20mm width X 23mm
depth blade

GREEN RETRACTOR



OM 55-0414 13mm width X 76mm without lip
OM 55-0415 18mm width X 76mm without lip
OM 55-0416 20mm width X 76mm without lip
OM 55-0417 23mm width X 76mm without lip
OM 55-0420 18mm width X 76mm depth blade
OM 55-0421 20mm width X 76mm depth blade
OM 55-0422 23mm width X 76mm depth blade

BLADE RETRACTOR
7 1/2" (191mm)

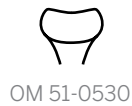

OM 51-0530
7mm width X 5mm depth
OM 51-0530 straight blade
OM 51-0532 angled 45° blade
OM 51-0534 angled 90° blade

LOVE NERVE RETRACTOR
8 1/2" (216mm)



OM 55-0426 8mm blade
OM 55-0428 13mm blade

**SCOVILLE NERVE
ROOT RETRACTOR**
9 1/4" (235mm) angled



OM 48-0234



OM 48-0237

OM 48-0234 7mm blade
OM 48-0237 9mm blade

HOLSHER NERVE RETRACTOR

9 1/2" (241mm)

Primarily used to retract the nerve root. Blunt hook.



OM 47-0881
4mm blunt, straight right angle tip

DANDY NERVE HOOK

9" (229mm)



OM 55-0424
6mm blade

NERVE ROOT RETRACTOR

9" (229mm)



OM 51-0521
9" (229mm)
12mm width X
10mm depth blade
fenestrated handle

CUSHING VEIN RETRACTOR



OM 55-0304
8 3/4" (222mm)
13mm width X
22mm depth blade
fenestrated blade and handle

CUSHING DECOMPRESSION RETRACTOR



OM 97-0310 7 1/4" (184mm) Large 3mm
OM 97-0315 7 1/4" (184mm) Small 2mm
OM 97-0318 7 1/4" (184mm) Small Ball Tip
OM 97-0320 10 7/8" (276mm) Small Ball Tip
OM 97-0322 7 1/4" (184mm) Large Ball Tip

KRAYENBUEHL NERVE HOOK

RETRACTORS

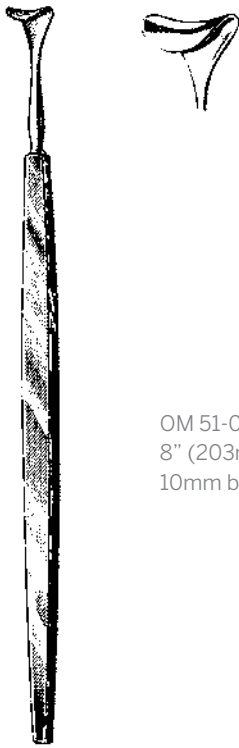

OM 51-0523
8" (203mm)
10mm blade

CUSHING VEIN RETRACTOR



LANGENBECK RETRACTOR
8 3/4" (222mm)



OM 51-0100
#1
3/8" X 1 1/4"
(10 X 32mm)



OM 51-0104
#2
3/8" X 1 1/2"
(10 X 38mm)



OM 51-0112
#4
5/8" X 1 1/2"
(16 X 38mm)



OM 51-0108
#3
1/2" X 1 1/2"
(13 X 38mm)



OM EM1010 4 prong 28mm depth

VOLKMAN RETRACTOR



VOLKMAN RETRACTOR
8 1/2" (216mm) with ring handle

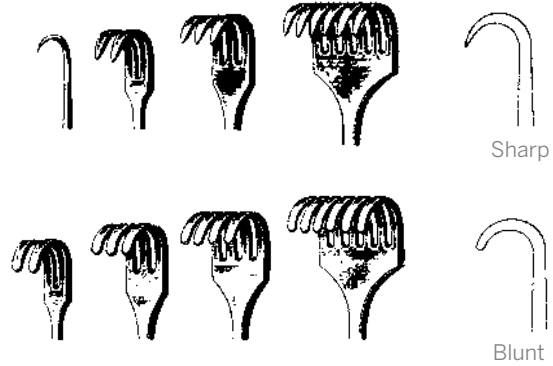

Sharp

- OM 52-0254 1 prong 10mm depth
- OM 52-0258 2 prongs 8mm width X 10mm depth
- OM 52-0262 3 prongs 13mm width X 10mm depth
- OM 52-0264 4 prongs 18mm width X 10mm depth
- OM 52-0266 6 prongs 28mm width X 10mm depth

Blunt

- OM 52-0268 2 prongs 8mm width X 10mm depth
- OM 52-0272 3 prongs 13mm width X 10mm depth
- OM 52-0274 4 prongs 18mm width X 10mm depth
- OM 52-0276 6 prongs 28mm width X 10mm depth

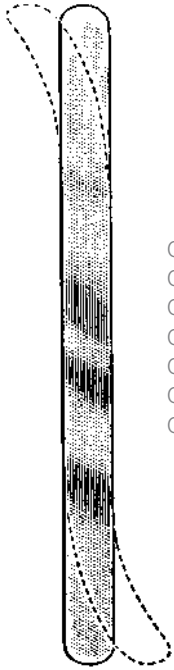

- OM 51-0752 6" X 1/2" (152mm X 13mm)
- OM 51-0755 7 1/2" X 1" (191mm X 25mm)
- OM 51-0766 13" X 3/4" (330mm X 19mm)
- OM 51-0768 13" X 1" (330mm X 25mm)
- OM 51-0770 13" X 1 1/4" (330mm X 32mm)
- OM 51-0772 13" X 1 1/2" (330mm X 38mm)
- OM 51-0776 13" X 2" (330mm X 51mm)

RIBBON RETRACTOR

Malleable

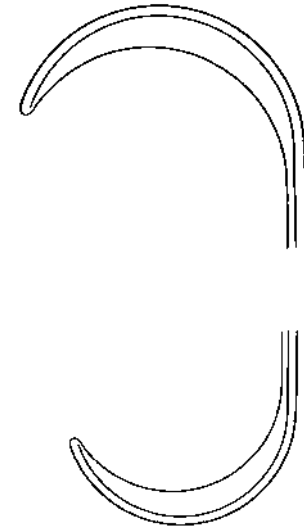

OM 51-0376
7 1/2" (191mm)
double ended

GOELET RETRACTOR



This variant of the Murphy Bone Skid features a strongly curved blade to better contour the humeral head. Serrations prevent slipping.

OM 46-0891
11" (280mm)
double ended, 20mm
and 30mm wide blades

SKID LEVER



OM 46-0892
12" (305mm)

MURPHY BONE SKID

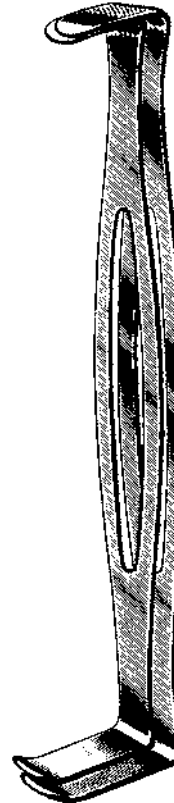

OM 51-0372
8 1/2" (216mm)
double ended, set of two
smaller: 15mm width X 25mm depth
and 15mm width X 30mm depth
larger: 15mm width X 37mm depth
and 15mm width X 42mm depth

U.S. ARMY RETRACTOR

RETRACTORS

OM 51-0059 25mm width X 50mm depth
OM 51-0060 26mm width X 75mm depth
OM 51-0061 25mm width X 100mm depth

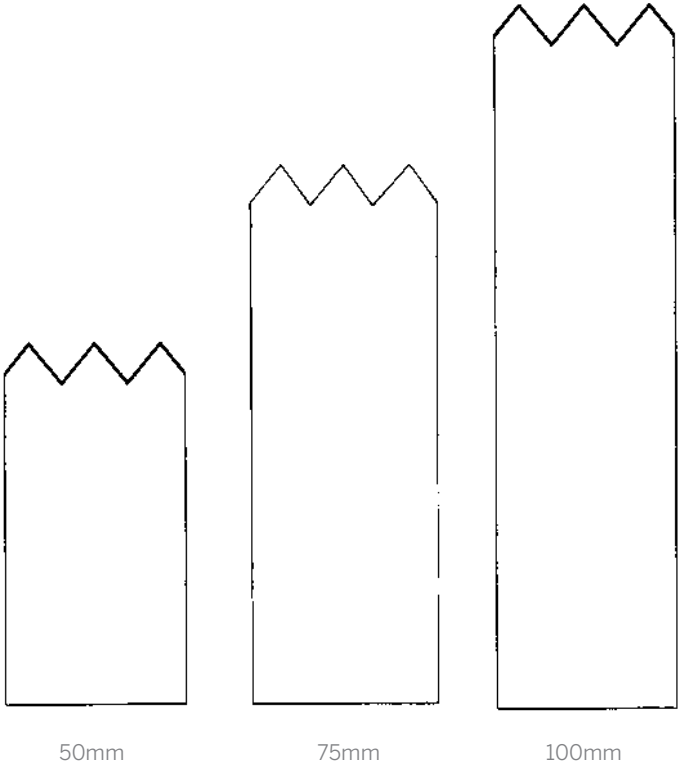

HIBBS RETRACTOR
9 1/2" (241mm) sharp teeth

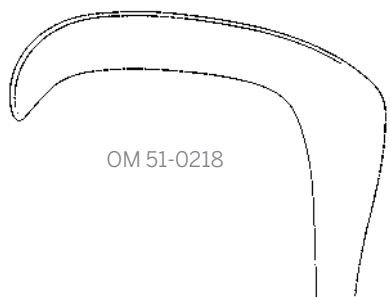

OM 51-0218



- OM 51-0216 1 1/2" X 2" blade
- OM 51-0218 2" X 2 1/2" blade
- OM 51-0220 2 1/2" X 3" blade
- OM 51-0222 3" X 3 1/2" blade

KELLY RETRACTOR
9 3/4" (248mm) with loop handle

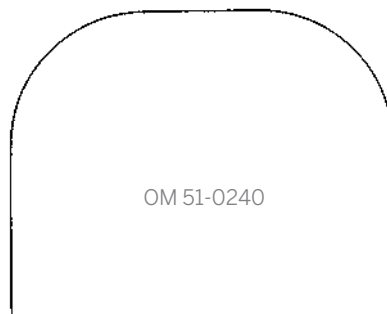

OM 51-0240



- OM 51-0230 1" wide X 10" long (25mm X 254mm)
- OM 51-0232 1" wide X 12" long (25mm X 305mm)
- OM 51-0234 1" wide X 13" long (25mm X 330mm)
- OM 51-0236 2 1/2" wide X 14 1/2" long (64mm X 368mm)
- OM 51-0238 3 1/2" wide X 12" long (89mm X 305mm)
- OM 51-0240 2" wide X 12" long (51mm X 305mm)
- OM 51-0242 3" wide X 12" long (76mm X 305mm)

DEAVER RETRACTOR
Hollow grip handle

RETRACTORS



DEAVER RETRACTOR PEDIATRIC
OM 51-0245 8 1/2" (216mm) 5/8" blade



DEAVER RETRACTOR
OM 51-0247 7" (178mm) 3/4" blade



DEAVER RETRACTOR PEDIATRIC
OM 51-0249 8 1/2" (216mm) 3/4" blade



DEAVER RETRACTOR
OM 51-0251 9" (229mm) 1" blade



DEAVER RETRACTOR PEDIATRIC
OM 51-0253 11 1/2" (292mm) 1 1/2" blade



DEAVER RETRACTOR
OM 51-0255 12" (305mm) 1" blade



DEAVER RETRACTOR
OM 51-0257 12" (305mm) 1 1/2" blade



DEAVER RETRACTOR
OM 51-0259 13" (330mm) 1" blade



DEAVER RETRACTOR
OM 51-0261 12" (305mm) 2" blade



DEAVER RETRACTOR
OM 51-0263 12" (305mm) 3" blade

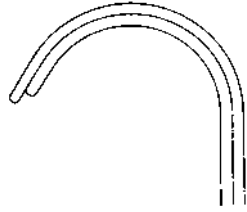

OM 51-0480
5" (127mm)
set

OM 51-0482
7 1/4" (184mm)
set

PARKER RETRACTOR

Double ended, set of two

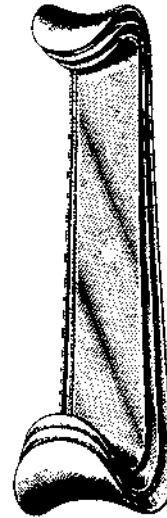

- OM 51-0498 5 1/4" (133mm) small
3/4" X 1" (19mm X 25mm)
- OM 51-0500 5 3/4" (146mm) medium
7/8" X 1 3/8" (22mm X 35mm)
- OM 51-0502 6 5/8" (173mm) large
1" X 1 5/8" (25mm X 41mm)

ROUX RETRACTOR

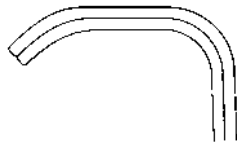

OM 51-0388
6" (152mm)
double ended
set of two

MAYO-COLLINS RETRACTOR

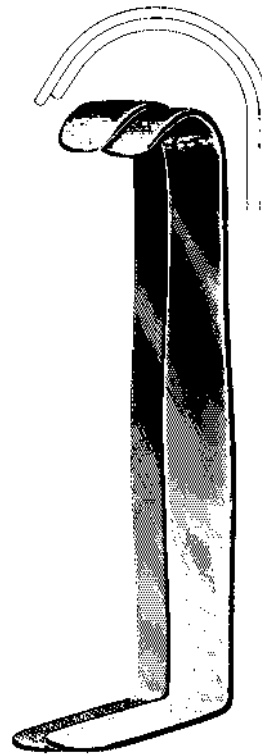

OM 51-0494
6" (152mm)
double ended
set of two

PARKER-MOTT RETRACTOR

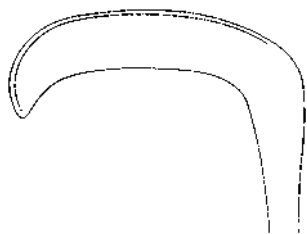

OM 51-0200 3/4" wide X 1" long blade
(19mm wide X 25mm long blade)
OM 51-0202 1" wide X 1 1/4" long blade
(25mm wide X 32mm long blade)
OM 51-0204 1 1/2" wide X 1 1/2" long blade
(38mm wide X 38mm long blade)

RICHARDSON RETRACTOR
9 1/2" (241mm)



OM 51-0206 9 1/2" (241mm)
3/4" wide X 2" long blade
(19mm wide X 51mm long blade)

RICHARDSON RETRACTOR



OM 51-0212 9 1/2" (241mm) small
OM 51-0214 10 1/4" (260mm) large
OM 51-0210 set of two

RICHARDSON-EASTMANN RETRACTOR

RETRACTORS

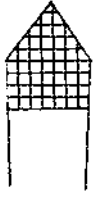

OM 48-0208
serrated pointed tip
10mm



OM 48-0214
smooth pointed tip
10mm

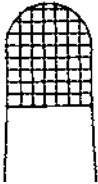

OM 48-0210
serrated blunt tip
10mm

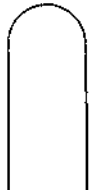

OM 48-0212
smooth blunt tip
10mm



AUFRANC COBRA RETRACTOR
10 1/2" with hollow handle, 1 1/4" blade width



OM 90-6130
12" (305mm) Blade at widest 33mm

COBRA RETRACTOR

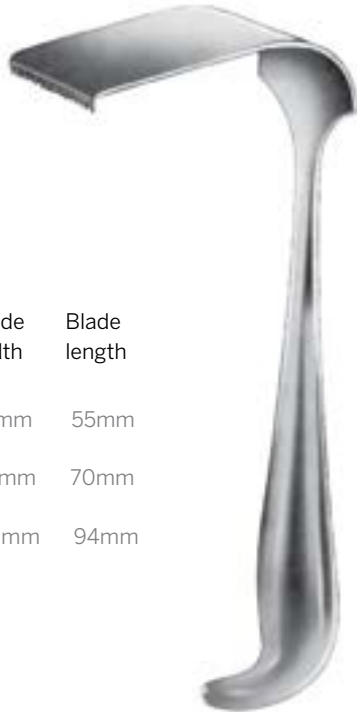

OM 51-0158
9" small
OM 51-0162
9" medium
OM 51-0164
10" large

Blade width	Blade length
17mm	55mm
25mm	70mm
50mm	94mm

MEYERDING LAMINECTOMY RETRACTOR
Sharp teeth



OM 46-0880



OM 46-0880
10" (254mm) small
1 3/4" blade width

OM 46-0884
10" (254mm) large
2 1/2" blade width

BENNETT BONE ELEVATOR AND RETRACTOR
Hollow handle



OM 52-0282
9" (229mm)
4 blunt prongs
56mm width X
40mm depth

OLLIER RAKE RETRACTOR



OM 51-0078

OM 51-0078
9 1/2" (241mm)
3 blunt prongs
30mm width X 37mm depth

OM 51-0080
9 1/2" (241mm)
4 blunt prongs
40mm width X 40mm depth

ISRAEL RAKE RETRACTOR



OM 86-0129
13" (330mm)

**MUELLER TYPER FEMORAL
NECK RETRACTOR W/
KNURLED HANDLE**



OM 90-6320

SINGLE PRONG BROAD
Acetabular Retractor 12"



OM 52-0296

OM 52-0292 2 1/4" width X 1 1/2" depth
OM 52-0294 2 1/4" width X 2" depth
OM 52-0296 2 1/4" width X 2 1/2" depth
OM 52-0298 2 1/4" width X 3" depth

DEEP RAKE RETRACTOR
10 1/2" (267mm) with 4 blunt prongs

HIP RETRACTORS

Note: These instruments are used to improve the exposure of the femoral canal prior to reaming or rasping for femoral prosthesis. Designed to elevate the proximal femur while retracting tissue during total or hemi-arthroplasty. The design provides excellent access to the intermedullary canal. The serrations at the tip grip and elevate the proximal femur.



OM 86-0130
13" (330mm)
50mm wide at tip, 68mm wide at
widest point of retractor blade.

FEMORAL NECK RETRACTOR



OM 86-0135
13" (330mm)
30mm wide at tip, 72mm wide at
widest point of retractor blade.
Blade is slightly concave.

FEMORAL NECK RETRACTOR
with suction hole



OM 90-7650-02
15 1/4" (387mm)
38mm blade width
6 1/4" (159mm) handle

FEMORAL NECK ELEVATOR
with extra leverage



Used to expose the
acetabulum of the
right hip.

OM 86-0140
10" (254mm) X 50mm

**INFERO-POSTERIOR
ACETABULAR CAPSULE
RETRACTOR**

Right



Used to expose the
acetabulum of the
left hip.

OM 86-0145
10" (254mm) X 50mm

**INFERO-POSTERIOR
ACETABULAR CAPSULE
RETRACTOR**

Left



OM 86-0137
19" (483mm),
tip 1 1/8" (28.5mm)
Serrated Upside Tip

BERTHA HIP RETRACTOR
with handle



OM 46-0870
2 blunt prongs
25mm width X 102mm depth

BRISTOW/BANKART HUMERAL RETRACTOR



OM 46-0908
10" (254mm) with 3 sharp prongs
22mm blade width

CAPSULE RETRACTOR



OM 46-0872
7 1/2" (191mm) with 3 blunt prongs
21mm blade width

**BRISTOW/BANKART
SOFT TISSUE RETRACTOR**



OM 46-0926 10 3/4"
small 10 1/2", 43mm wide

OM 46-0927
large 10 1/2", 53mm wide

BROWNE DELTOID RETRACTOR

SHOULDER RETRACTORS

Modification to the original Fukuda design incorporates an additional forward bend at the distal 15mm. This allows the retractor to sit firmly on the posterior neck of the glenoid and reduces the chance of glenoid rim fractures. A series of shallow atraumatic grooves around the rim of the fenestration improves traction.

OM 46-0909
10" (255mm)
30mm wide blade

OM 46-0910
10" (255mm)
35mm wide blade



MODIFIED FUDUKA HUMERAL HEAD RETRACTOR

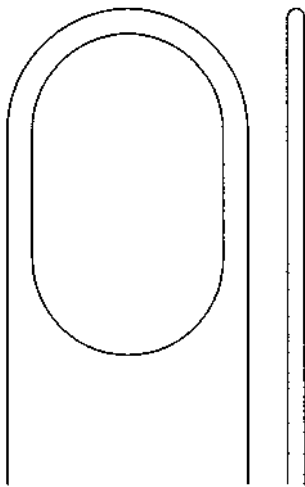

OM 46-0907
32mm width X 81mm length blade

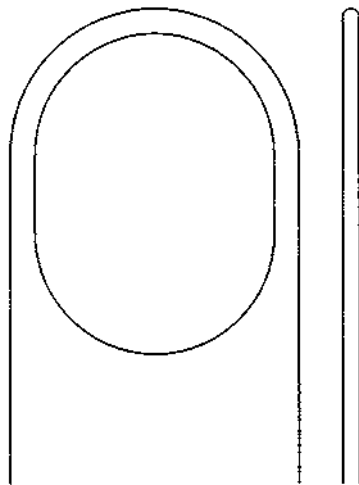

OM 46-0906
38mm width X 81mm length blade



FUKUDA STYLE SHOULDER RETRACTOR

7" (178mm)

Designed to gain optimal access to the subacromium space by distracting inferiorly the humeral head from the acromium. Perfect for massive tears and repair of a supraspinatus tear.

OM 86-0005
7" (178mm) long
right

OM 86-0010
7" (178mm) long
left



SUBACROMIUM RETRACTOR

The Goldstein retractor is placed along the glenoid rim during open Bankart Procedures to allow excellent exposure. The advantage this has over existing retractors is that the convex teeth sit easily into the glenoid rim while the strong end of the shaft allows the instrument to stay out of the surgeons view.

OM 86-0015
9" (229mm)
18mm wide tip

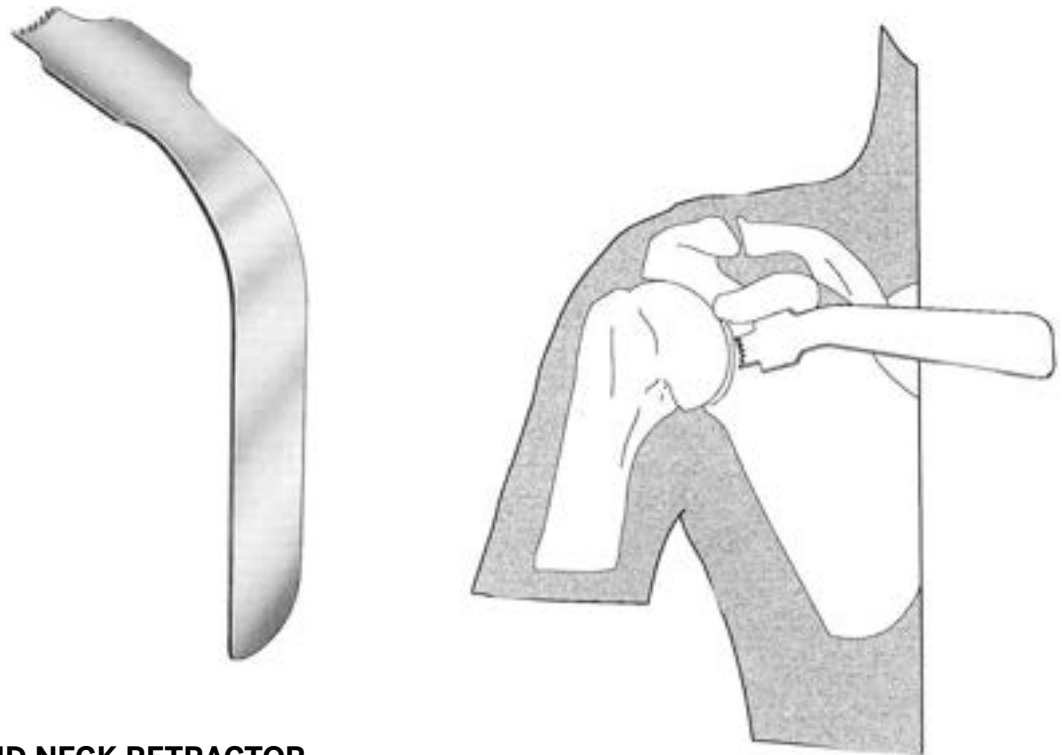

GOLDSTEIN GLENOID NECK RETRACTOR

The retractor's teeth are specifically designed to retract the subscapularis and capsule medially during a Bankart procedure. The wide midsection retracts the soft tissue during anterior glenoid work. The curved handle allows the assistant to use minimal pressure to achieve exposure.

OM 86-0030
11" (279mm) long X 25mm tip

ANTERIOR GLENOID NECK RETRACTOR



Used during osteotomy of the humeral head and approaches to the glenoid. It is designed to allow one finger retraction and contours to allow teeth to fit behind the glenoid, retracting tissue for easy access to the glenoid.

OM 86-0025
10" (254mm) long X 30mm

POSTERIOR GLENOID NECK RETRACTOR



Fits easily under the acromion, deltoid and over the humeral head. Used in most open procedures.

OM 86-0020
8" (203mm) long X 30mm

DELTOID RETRACTOR

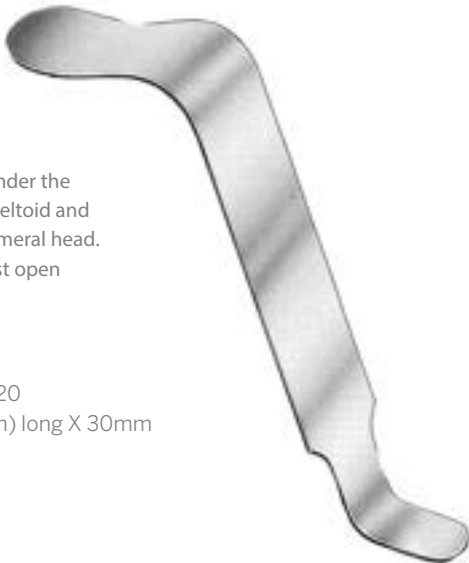

This retractor is placed between the glenoid and the humeral head to obtain excellent exposure. The two prongs wrap around the posterior rim to help distribute the applied force to the glenoid neck.

OM 86-0035
7" (180mm)
strong curve

HUMERAL HEAD RETRACTOR



OM 86-0098
8 1/4" (209mm)



KOLBEL RETRACTOR

OM 86-0099
8 1/4" (209mm)



KOLBEL RETRACTOR RING HANDLE 8" HINGED



OM 86-0050

OM 86-0050
20mm X 36mm pair
popular in early stages and small incision procedures



OM 86-0055

OM 86-0055
20mm X 53mm pair
popular in early stages and small incision procedures



OM 86-0060

OM 86-0060
20mm X 68mm pair
popular in early stages and small incision procedures



OM 86-0065

OM 86-0065
20mm X 85mm pair
for larger muscle patients



OM 86-0070

OM 86-0070
36mm X 36mm pair
standard size, most popular



OM 86-0075

OM 86-0075
36mm X 53mm pair
standard size, most popular



OM 86-0080

OM 86-0080
36mm X 68mm pair
standard size, most popular



OM 86-0085

OM 86-0085
36mm X 85mm pair
for larger muscle patients

KOLBEL RETRACTOR BLADES

Pairs, 2 blades

SHOULDER RETRACTORS



OM 86-0103
8 1/4" (209mm)

OM 86-0107
with three center blades

OM 86-0104
Retractor only (to be used with center blades)

OM 86-0106
Center blade 36mm x 20mm

OM 86-0108
Center blade 53mm x 20mm

OM 86-0109
Center blade 68mm x 20mm

KOLBEL RETRACTOR
with one center blade



OM 46-0874
9" (229mm)
11mm wide blade

**SINGLE POINT
GLENOID RETRACTOR**



OM 46-0875
10" (254mm)
25mm wide blade

**HUMERAL HEAD
RETRACTOR**



These two retractors sit in the glenoid neck and retract medially the subscapularis. Also, during instability repairs they assist in tacking down the medial flap of the incised capsule.

OM 86-0040
15mm
wide blade

OM 86-0045
20mm
wide blade

GLENOID LEVER



OM 46-0922
7" (179mm)
2 X 2 prong angled

KOLBEL SUBSCAPULARIS RETRACTOR



OM 86-0090
no blades included

KOLBEL SHOULDER RETRACTOR

Square frame only

The single prong Retractor is commonly used when retracting on the interior rim of the glenoid.

OM 86-0100
10" (254mm)
20mm wide



CAPSULE RETRACTOR
One prong

Designed to be placed medially along the scapular neck to retract the anterior capsule and labrium.

OM 86-0105
10" (254mm)
20mm wide



CAPSULE RETRACTOR
Two prong

Designed to be placed medially along the scapular neck to retract the anterior capsule and labrium.

OM 86-0110
10" (254mm)
20mm wide



CAPSULE RETRACTOR
Three prong

OM 46-0860
8 3/4" (222mm)
18mm blade width

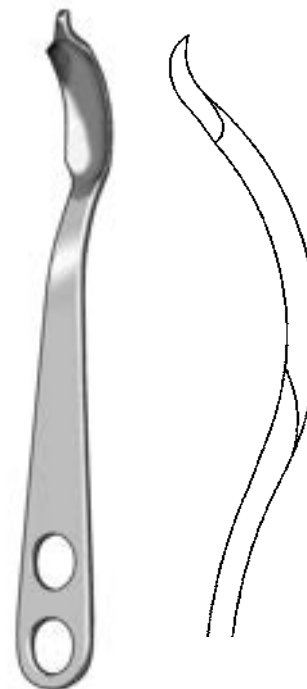

HUMERAL HEAD RETRACTOR

PELVIC, SHOULDER AND KNEE RETRACTORS

OM 48-0201
10 3/4" (273mm)
24mm blade width

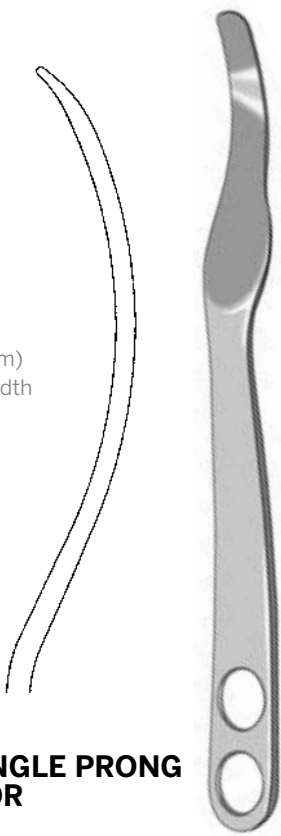

PELVIC SINGLE PRONG RETRACTOR

OM 48-0204
10 1/2" (267mm)
44mm blade width



BLOUNT DOUBLE PRONG RETRACTOR

OM 48-0202
10 1/2" (267mm)
37mm blade width



BLOUNT SINGLE PRONG RETRACTOR

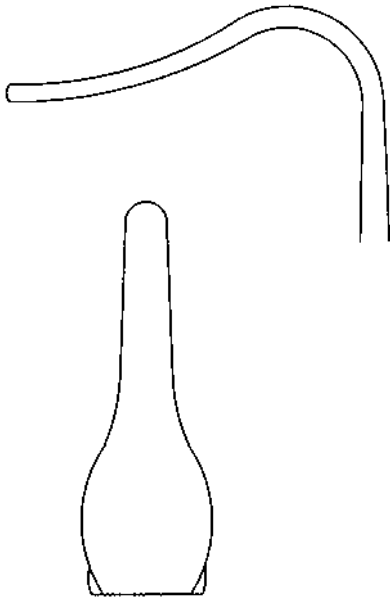

OM 48-0206
7" (178mm)
6mm width distal tip

BLOUNT KNEE RETRACTOR



OM 48-0180
57mm blades, 69mm deep, 11mm wide

OM 48-0184
63mm blades, 76mm deep, 11mm wide

DOANE KNEE RETRACTOR
6" (152mm) a.k.a. "Z" Retractor

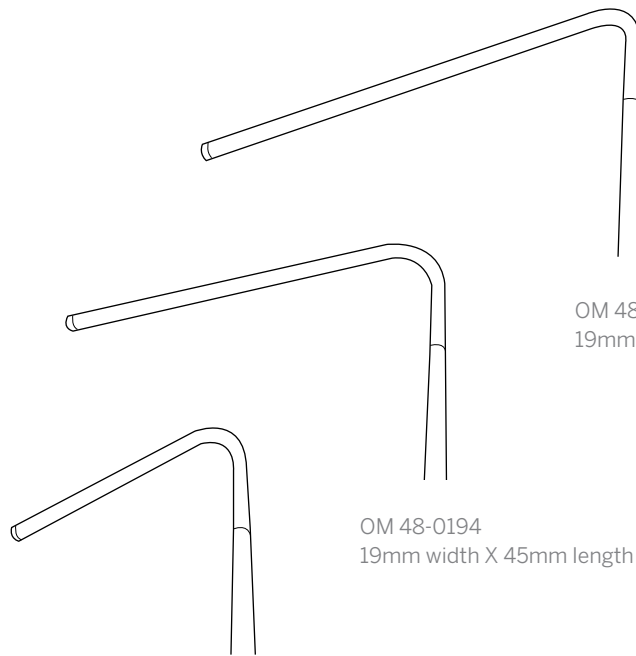

OM 48-0196
19mm width X 60mm length blade

OM 48-0194
19mm width X 45mm length blade

OM 48-0198
19mm width X 30mm length blade

SMILLIE KNEE RETRACTOR

5 1/2" (140mm)

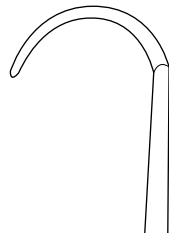

OM 48-0200
5 1/2" (140mm)
full curve
13mm width X 18mm length blade

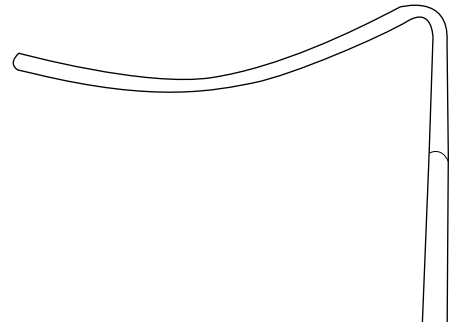

OM 48-0192
5 1/2" (140mm)
reverse curve
13mm width X 55mm length blade

SMILLIE KNEE RETRACTOR

SMILLIE KNEE RETRACTOR

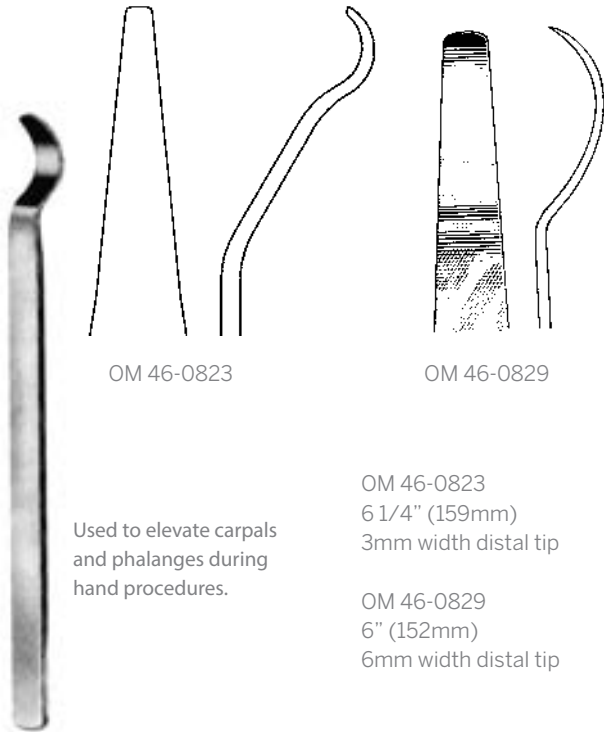

OM 46-0823

OM 46-0829

Used to elevate carpals and phalanges during hand procedures.

OM 46-0823
6 1/4" (159mm)
3mm width distal tip

OM 46-0829
6" (152mm)
6mm width distal tip

HAYES HAND RETRACTOR



OM 46-0827
6" (152mm)
broad tip
15mm blade width

HOHMANN RETRACTOR

For small fragments.



OM 46-0826
4 3/4" (121mm) with finger ring
broad tip
16mm blade width

HOHMANN RETRACTOR

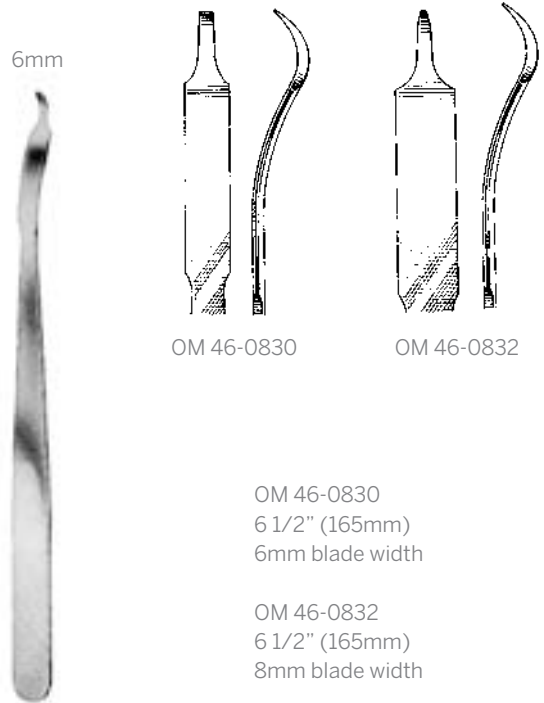

OM 46-0830

OM 46-0832

OM 46-0830
6 1/2" (165mm)
6mm blade width

OM 46-0832
6 1/2" (165mm)
8mm blade width

MINI HOHMANN RETRACTOR

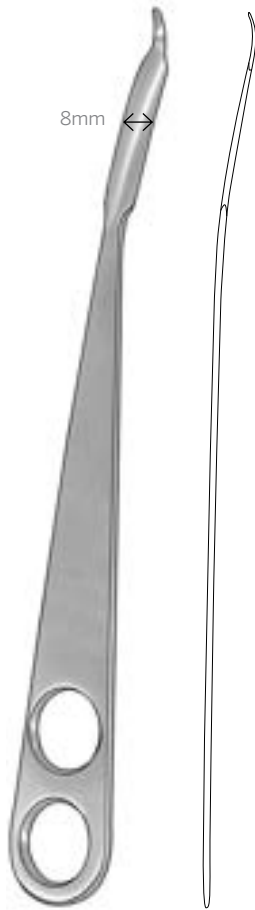

OM 46-0858
8 1/2" (216mm)
8mm blade width

OM 46-0836
9" (229mm)
10mm blade width

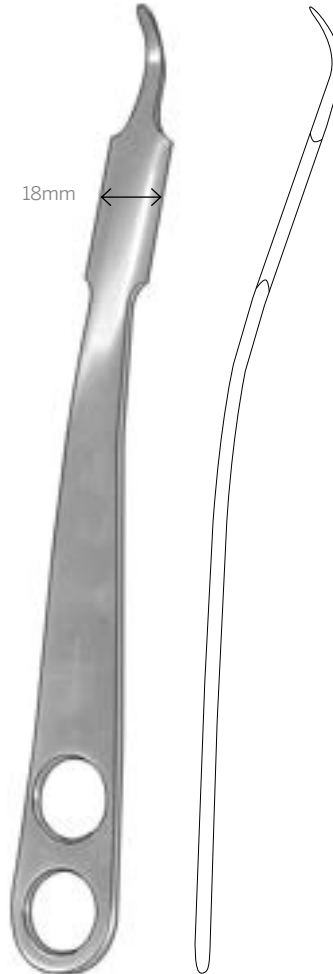

OM 46-0838
9" (229mm)
18mm blade width

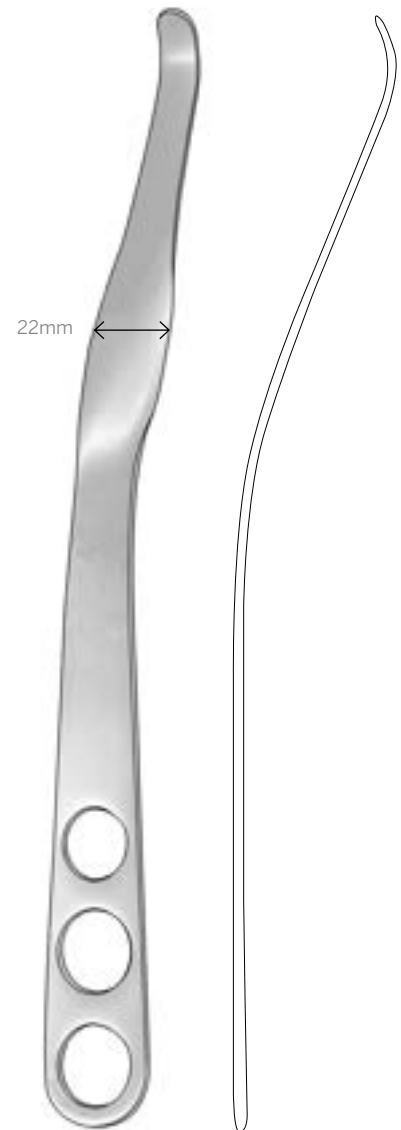

OM 46-0848
11" (279mm)
22mm blade width
3 holes

HOHMANN RETRACTOR

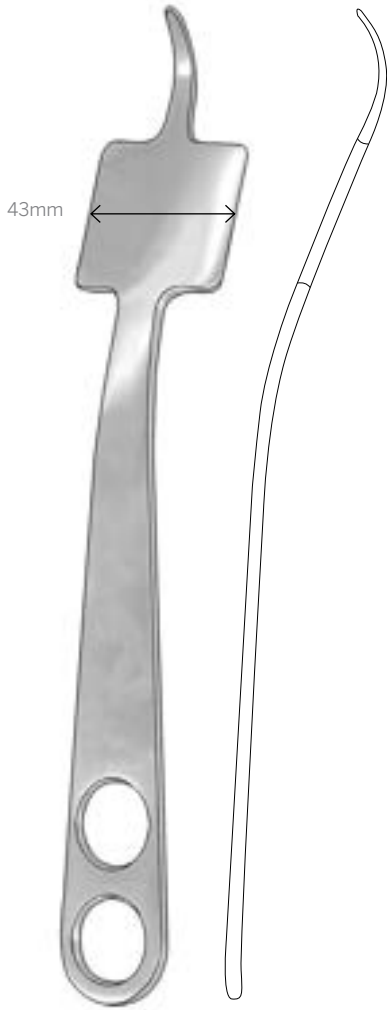

OM 46-0842
9 1/2" (241mm)
43mm blade width

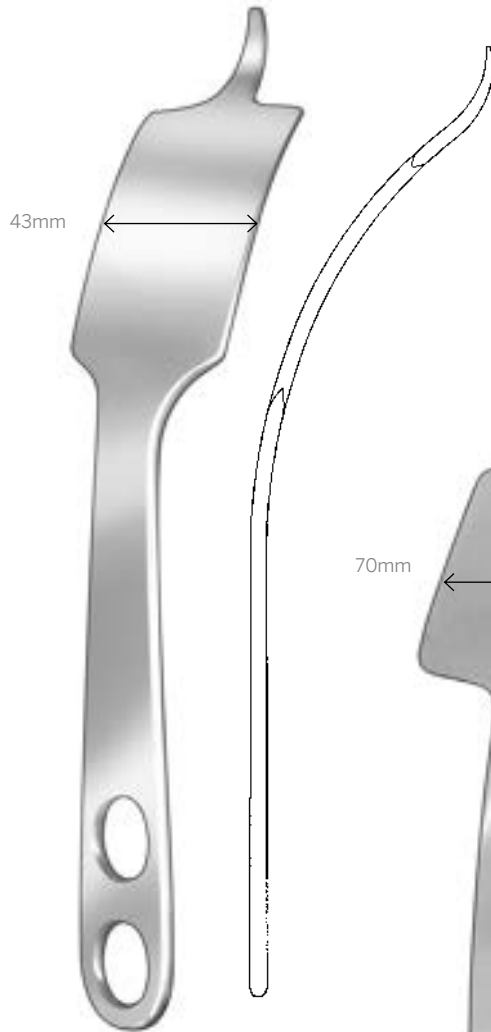

OM 46-0841
9" (228mm)
43mm blade width
long 64mm shank

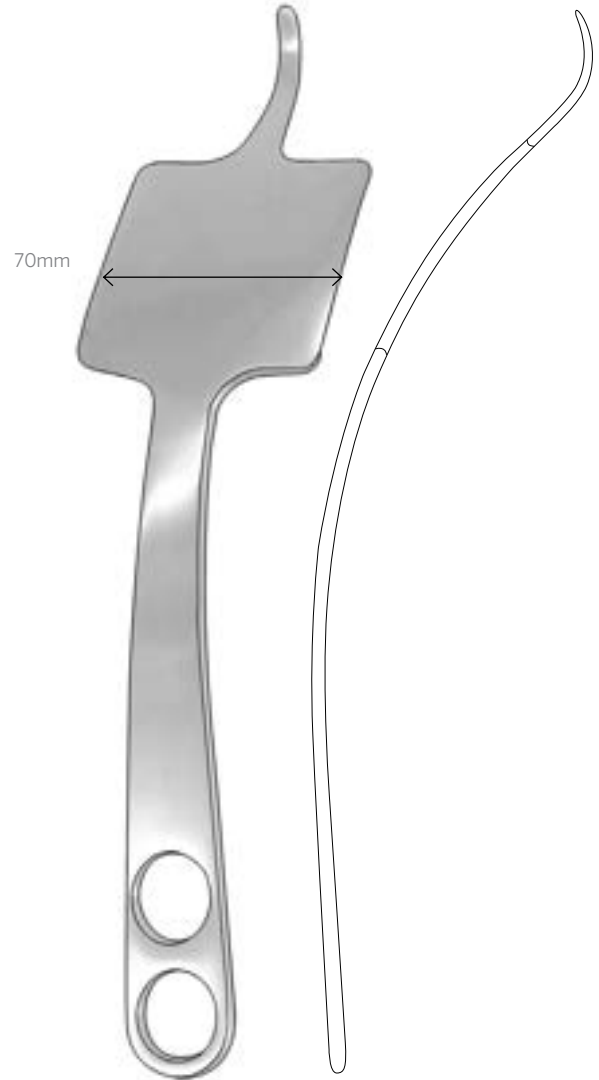

OM 46-0850
9 1/2" (241mm)
70mm blade width

HOHMANN RETRACTORS

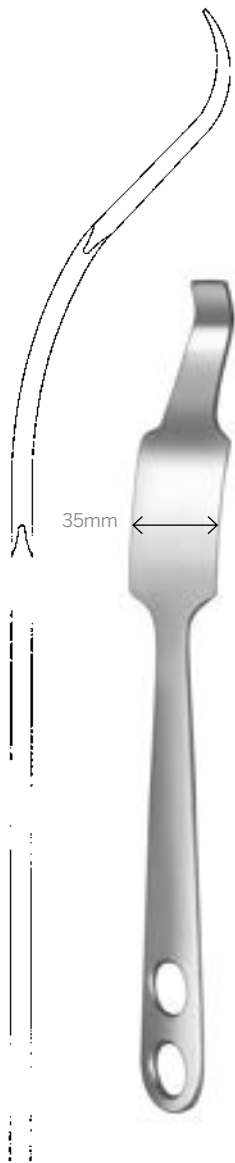

OM 46-0849
 11 1/4" (286mm)
 35mm blade width
 with wide tip
 long 52mm shank

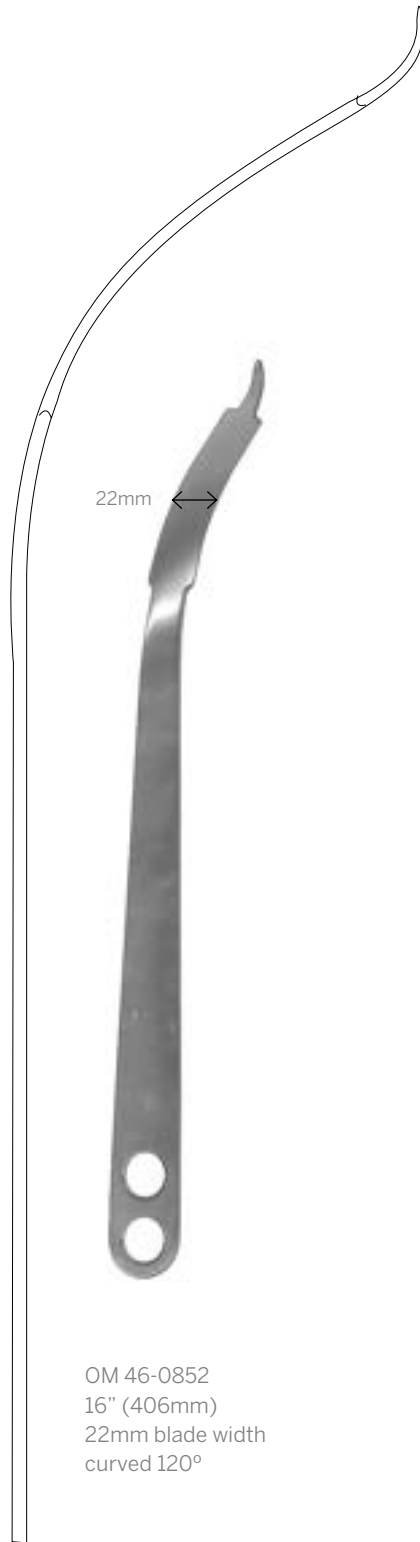

OM 46-0852
 16" (406mm)
 22mm blade width
 curved 120°

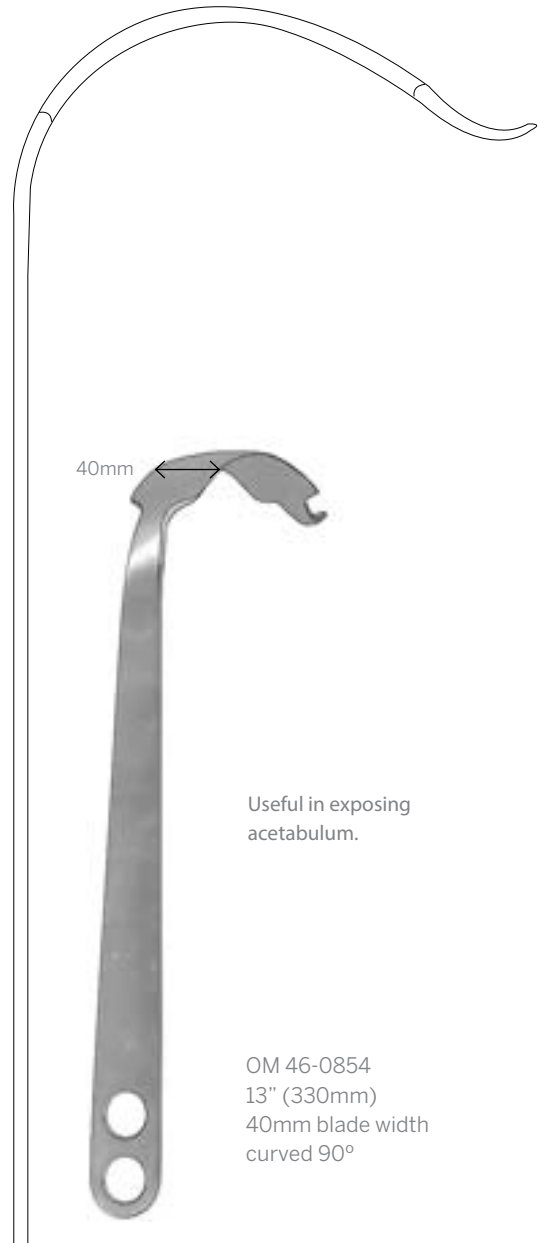

Useful in exposing
 acetabulum.

OM 46-0854
 13" (330mm)
 40mm blade width
 curved 90°

HOHMANN RETRACTOR

RETRACTORS



OM 90-6210-02
12 1/2" (318mm)
15mm blade width

**DOUBLE BENT HOHMAN
RETRACTOR**



OM 46-0840
10" (254mm)
15mm blade width

HOHMAN RETRACTOR



OM 82-0033
8" (203mm)
8mm blade width

BODNER RETRACTOR NARROW



OM DP29995860
11 1/2" (295mm)

**MOTHER-IN-LAW
RETRACTOR**



OM 46-0851
11 1/2" (295mm)
23mm blade width

HOHMAN RETRACTOR



OM 46-0838S
9" (229mm)
18mm blade width square tip

HOHMAN RETRACTOR

OM 46-0868
90 degree bend 10mm blade width

WAITING ON IMAGE FROM
ORTHOMED

**RIGHT ANGLED
HOHMANN RETRACTOR**

OM 90-7110
11" (280mm) right angle
18mm blade width

BENT HOHMANN

OM 86-0120L
12 1/2" (318mm) right angle
18mm blade width

**RIGHT ANGLE HOHMANN
RETRACTOR LONG**



OM 46-0855
11" (280mm) right angle
22mm blade round tip

**RIGHT ANGLED
HOHMANN RETRACTOR**



OM 90-6630
8" (208mm)
21mm blade width

**COLLATERAL LIGAMENT
RETRACTOR LONG PRONG**



OM 86-0115L
10 1/4"
43mm blade width

**RIGHT ANGLED HOHMANN
RETRACTOR LONG**

RETRACTORS



OM 90-3220-02
9 1/8", 19mm Blade Width

CHANDLER RETRACTORS



OM 90-6570
12" (305mm)
22mm blade width

**SINGLE PRONG
ACETABULAR RETRACTOR**



OM 86-0170
11" (280mm)
5 1/2" (139mm) blade length
2" (50mm) blade width

NERVE RETRACTOR SHORT



OM 86-0172
11" (280mm)
7 1/2" (191mm) blade length
2" (50mm) blade width

NERVE RETRACTOR LONG



OM SP-1066
8" (203mm)
1 1/4" width X 5" blade length

TAYLOR RETRACTOR LONG BLADE

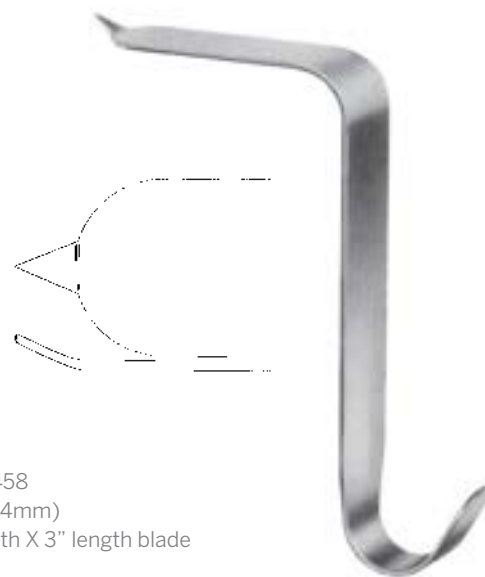

OM 52-0458
7 1/4" (184mm)
1 1/4" width X 3" length blade

OM 52-0460
8" (203mm)
1 1/4" width X 4" length blade

TAYLOR SPINAL RETRACTOR



OM 90-3410

SINGLE PRONG BROAD ACETABULAR RETRACTOR 12"

The hook at the end of the retractor engages the radius as the wing retracts the pronator, but the wing does not contact the median nerve. The section above the wing which contacts the median nerve has been narrowed to avoid excessive pressure, and possible damage to the nerve.



OM 91-0500
6 3/8" (164mm) Overall length
1 1/16" (27mm) Wing width

CARLSON PRONATOR RETRACTOR 2MM

RETRACTORS



Right angled Hohmann's are useful in both knee and hip arthroplasty for retracting tissue at the margins of the joint. It is placed over the margins of the joint to achieve maximum exposure.

The "C" retractor is designed to retract the femur anteriorly during total hip arthroplasty. Placement is made over the pelvic brim for best exposure.

Wide blade designed for retracting around the hip. Very useful for retracting tissue in the posterior acetabular brim.

OM 86-0125
14" (356mm)
22mm wide blade

"C" RETRACTOR



OM 86-0120
9 3/4" long
18mm wide blade

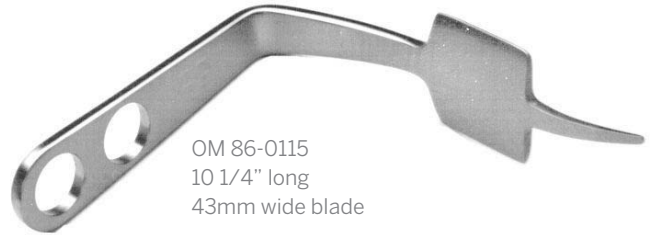

OM 86-0115
10 1/4" long
43mm wide blade

RIGHT ANGLED HOHMANN RETRACTOR

Designed to retract and give exposure to the iliac crest for graft harvesting.

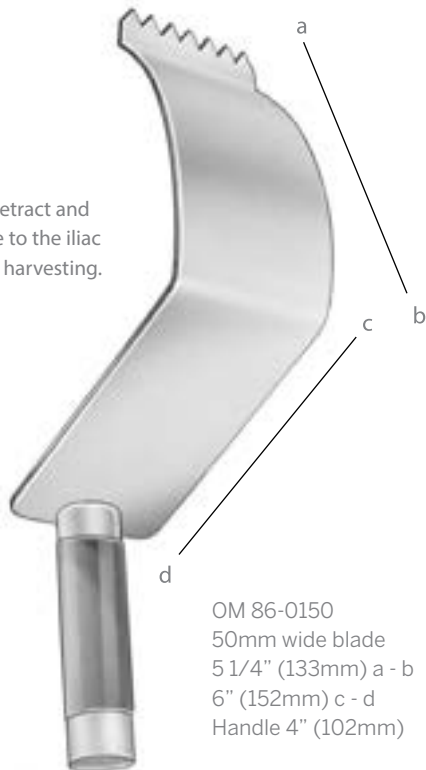

OM 86-0150
50mm wide blade
5 1/4" (133mm) a - b
6" (152mm) c - d
Handle 4" (102mm)

WAUGH RETRACTOR

For spine



OM 86-0155
15" (38mm)

ACETABULAR RETRACTOR

Note: The new Vickers retractors are designed to provide excellent visibility during hand and wrist procedures. Each of the retractors are self-retaining and automatically expand the wound site.

Ideal for retracting wounds on either the front, back or sides of fingers or thumb.



OM 52-0425
2" X 3/4" X 1 1/4"
(51mm X 19mm X 32mm)
2 X 2 blunt hooks
maximum opening: 3/4"

VICKERS FINGER RETRACTOR

Note: Useful for trigger finger and small wound retraction. The curved smooth blades hold fat tissue away from tendon sheath.

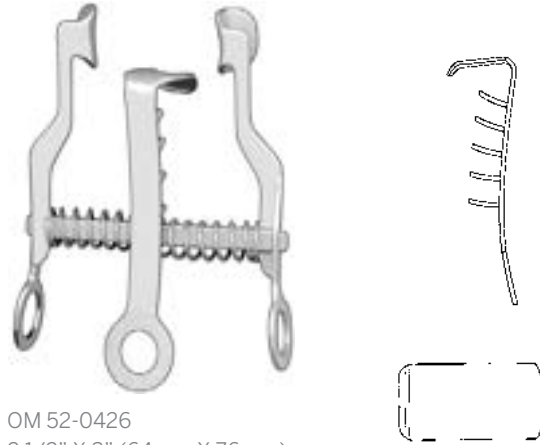

OM 52-0426
2 1/2" X 3" (64mm X 76mm)
10mm depth X 12mm height
curved smooth blades
maximum opening: 30mm
center blade: 10mm X 16mm

Center blade for low profile retractors.

VICKERS LOW PROFILE SMALL WOUND RETRACT

Ideal for tendon transfers with three blunt prongs to secure placement.

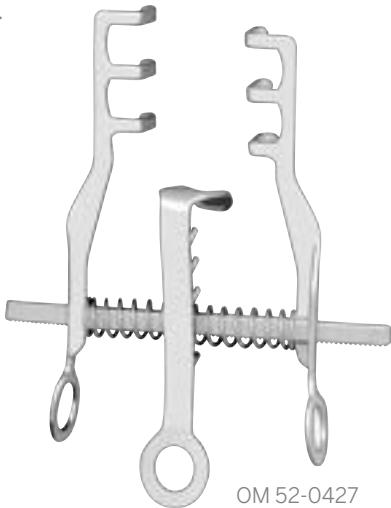

OM 52-0427
3" X 3 3/4" (76mm X 95mm)
3 X 3 blunt prongs
11mm depth X 25mm height
maximum opening: 35mm
center blade: 10mm X 16mm

VICKERS LOW PROFILE HAND AND FOREARM RETRACTOR

Useful for hand and carpal tunnel procedures with two blunt prongs to secure placement.



OM 52-0428
2 1/2" X 3" (64mm X 76mm)
2 X 2 blunt prongs
8mm depth X 17mm height
maximum opening: 30mm
center blade: 10mm X 16mm

VICKERS LOW PROFILE UNIVERSAL RETRACTOR

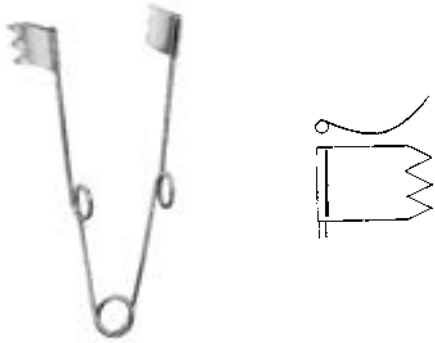

OM 52-0420
 3 1/4" (83mm) very delicate
 3 X 3 teeth
 10mm width X 13mm height blades

SPRING WIRE RETRACTOR

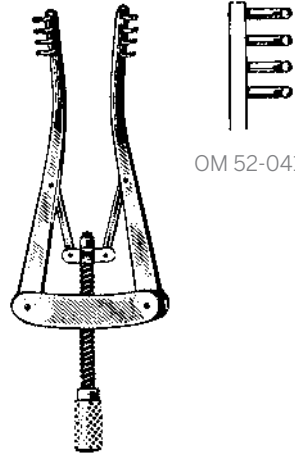

OM 52-0416

OM 52-0414
 2 3/4" (70mm) delicate
 4mm depth X 8mm height

OM 52-0416
 4" (102mm) delicate
 5mm depth X 9mm height

ALM RETRACTOR

4 blunt prongs



OM 52-0418

OM 52-0417
 4" (102mm) delicate
 4 sharp prongs
 3mm depth X 8mm height

OM 52-0418
 4" (102mm) delicate
 4 blunt prongs
 3mm depth X 8mm height

**SELF-RETAINING RETRACTOR
 (HEISS)**



OM 52-0422
 4" (102mm)
 3 X 3 blunt prongs

OM 47-0423
 4" (102mm)
 3 X 3 sharp prongs

JANSEN RETRACTOR



OM 48-0223
6 3/4" (171mm)
for up to .062" (1.6mm)

OM 48-0224
6 3/4" (171mm)
for up to 7/64" (2.8mm)

JOINT AND CALCANEAL SPREADER



Two hole design allows for .062"
(1.6mm) and 3/32" (2.4mm) wire.

OM 90-4210-SS Distractor 6" (152mm)
OM 90-4210-SB Distractor 6" (152mm) bent

JOINT CALCANEAL (Hintermann)

SELF-RETAINING RETRACTORS

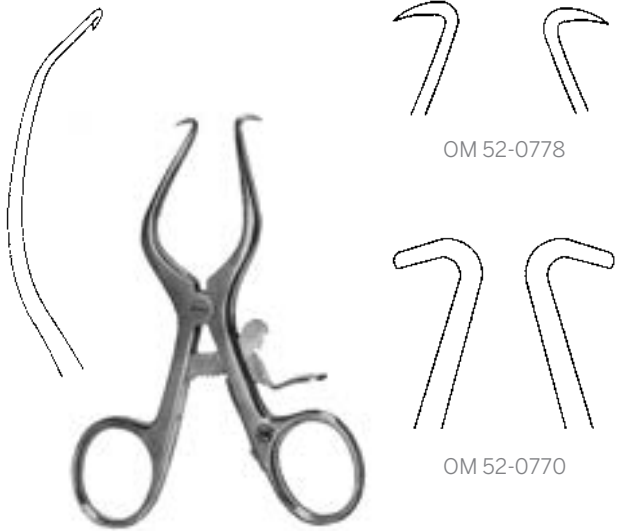

Sharp Points
 OM 52-0776 3 1/2" (89mm)
 OM 52-0778 4 1/2" (114mm)
 OM 52-0780 5 1/2" (140mm)
 OM 52-0768 7 1/2" (191mm)

Blunt Points
 OM 52-0770 7 1/2" (191mm)

GELPI RETRACTOR



OM 52-0765
 6 1/4" (159mm)
 sharp points
 deep blades

OM 52-0766
 6 1/4" (159mm)
 blunt

GELPI-SELETZ RETRACTOR

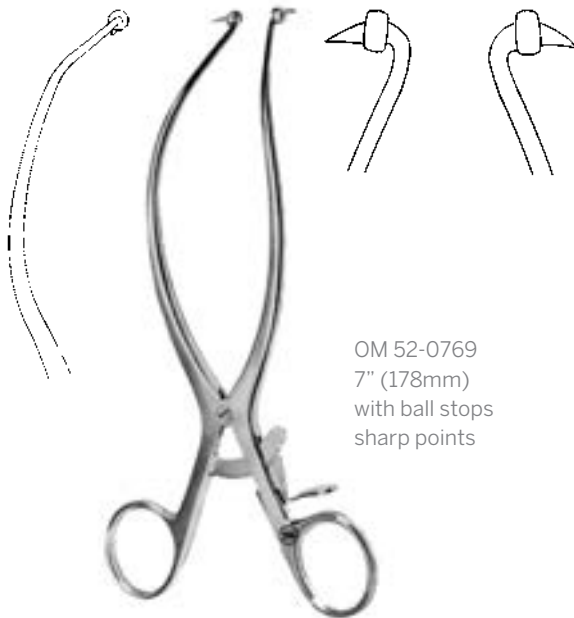

OM 52-0769
 7" (178mm)
 with ball stops
 sharp points

GELPI RETRACTOR

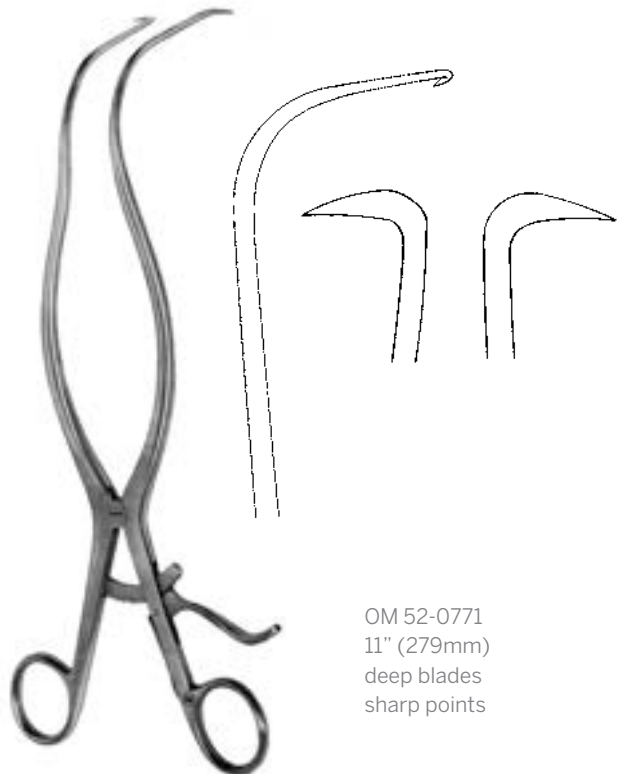

OM 52-0771
 11" (279mm)
 deep blades
 sharp points

WILTSE-GELPI RETRACTOR

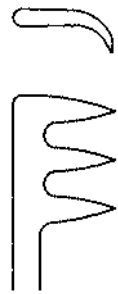

OM 55-0497
 4 1/4" (108mm)
 3 X 3 sharp prongs
 10mm depth x 14mm height

SNITMAN ENDAURAL RETRACTOR

Handle conforms to contour of skull. Also useful in hand and foot procedures because handle is not obstructive.

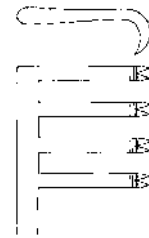

OM 52-0548
 5 1/2" (140mm)
 3 X 4 sharp prongs
 15mm depth X 20mm height

OM 52-0546
 5 1/2" (140mm)
 3 X 4 blunt prongs
 15mm depth X 20mm height

SCALP CONTOUR RETRACTOR

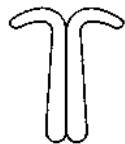

OM 55-0438
 5 1/4" (133mm)
 1 X 1 blunt prongs
 13mm depth

TISSUE RETRACTOR

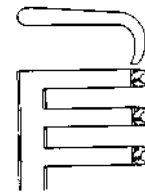
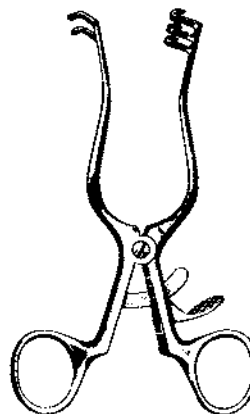

OM 52-0492

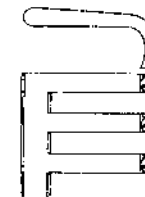

OM 52-0494

OM 52-0492
 4" (102mm) sharp
 2 X 3 prongs
 13mm depth X 13mm height

OM 52-0494
 4" (102mm) blunt
 2 X 3 prongs
 13mm depth X 13mm height

WEITLANER RETRACTOR

SELF-RETAINING RETRACTORS

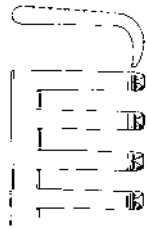
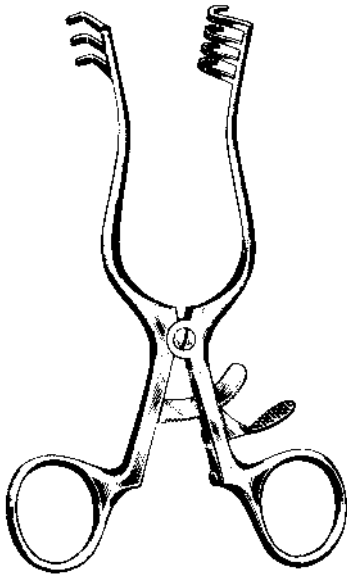

OM 52-0498



OM 52-0518

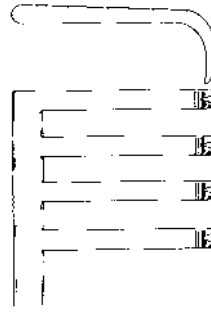

OM 52-0506

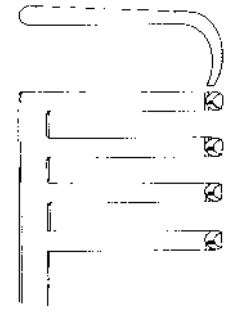

OM 52-0526

3 X 4 sharp prongs

OM 52-0498	5 1/2" (140mm)	14mm depth X 18mm height
OM 52-0502	6 1/2" (165mm)	15mm depth X 20mm height
OM 52-0504	8" (203mm)	16mm depth X 20mm height
OM 52-0506	9 1/2" (241mm)	23mm depth X 21mm height

3 X 4 blunt prongs

OM 52-0518	5 1/2" (140mm)	14mm depth X 18mm height
OM 52-0522	6 1/2" (165mm)	15mm depth X 20mm height
OM 52-0524	8" (203mm)	16mm depth X 20mm height
OM 52-0526	9 1/2" (241mm)	23mm depth X 21mm height

WEITLANER RETRACTOR

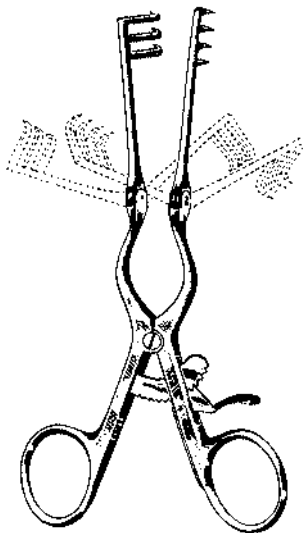

OM 52-0532

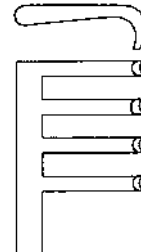

OM 52-0538

3 X 4 sharp prongs

OM 52-0530	5 1/2" (140mm)	15mm depth X 20mm height
OM 52-0532	6 1/2" (165mm)	15mm depth X 20mm height
OM 52-0534	8 1/2" (216mm)	17mm depth X 22mm height
OM 52-0542	9 1/2" (241mm)	24mm depth X 22mm height

3 X 4 blunt prongs

OM 52-0536	5 1/2" (140mm)	15mm depth X 20mm height
OM 52-0538	6 1/2" (165mm)	15mm depth X 20mm height
OM 52-0540	8 1/2" (216mm)	17mm depth X 22mm height
OM 52-0544	9 1/2" (241mm)	24mm depth X 22mm height

BECKMAN-WEITLANER RETRACTOR

Hinged blades

OM 52-0442
 7 1/2" (191mm) straight
 4 X 4 sharp prongs
 18mm depth X 18mm height



ADSON RETRACTOR

OM 52-0444
 7 1/2" (191mm) angled
 4 X 4 sharp prongs
 18mm depth X 18mm height



ADSON RETRACTOR UNDERNEATH

Note:

- Ratchet is calibrated in millimeters to accurately assess how wide the lateral portion of the bone graft needs to be.
- Helpful in many types of procedures to accurately assess the amount of bone graft needed, such as for fusions and nonunions.



**SAXENA BONE GRAFTING
 RETRACTOR**



OM 48-0220
 6 1/2" (165mm)
 35mm calibrated ratchet

OM 48-0221
 10" (254mm)
 70mm calibrated ratchet



Angular prongs are heavier than those on a standard Adson.

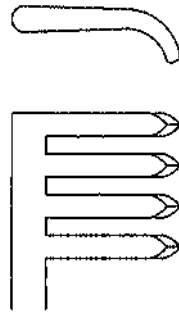

OM 55-0498
7 3/8" (187mm)
4 X 4 sharp prongs
22mm depth X 19mm height

D'ERRICO-ADSON RETRACTOR

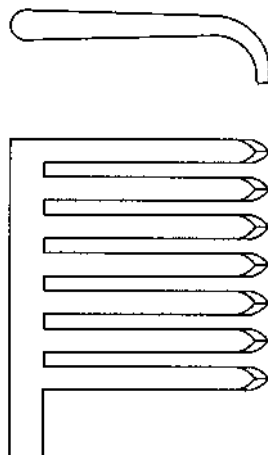

OM 55-0499
7 1/2" (191mm)
7 X 7 sharp prongs
35mm depth X 32mm height

OM 55-0500
7 1/2" (191mm)
7 X 7 blunt prongs
35mm depth X 32mm height

MISKIMON CEREBELLUM RETRACTOR

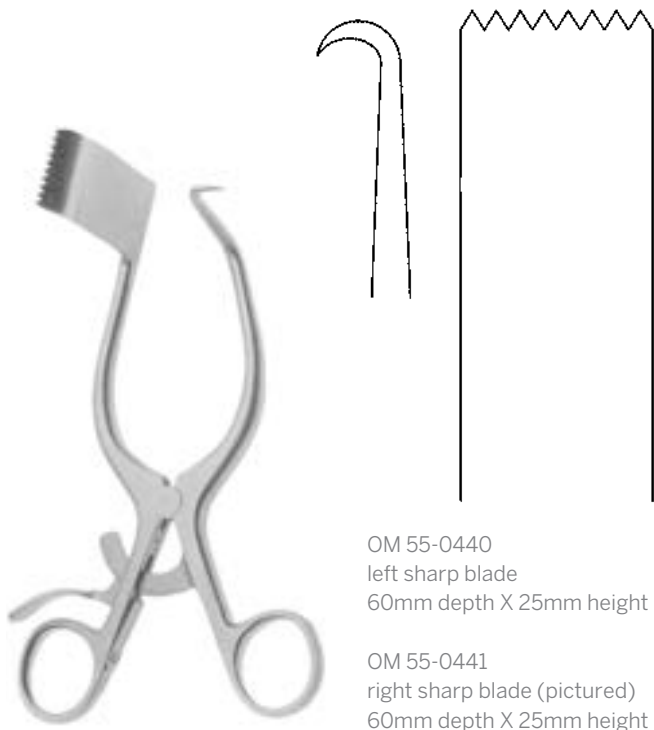

OM 55-0440
left sharp blade
60mm depth X 25mm height

OM 55-0441
right sharp blade (pictured)
60mm depth X 25mm height

**MARKHAM-MEYERDING
HEMILAMINECTOMY RETRACTOR**
7" (178mm)

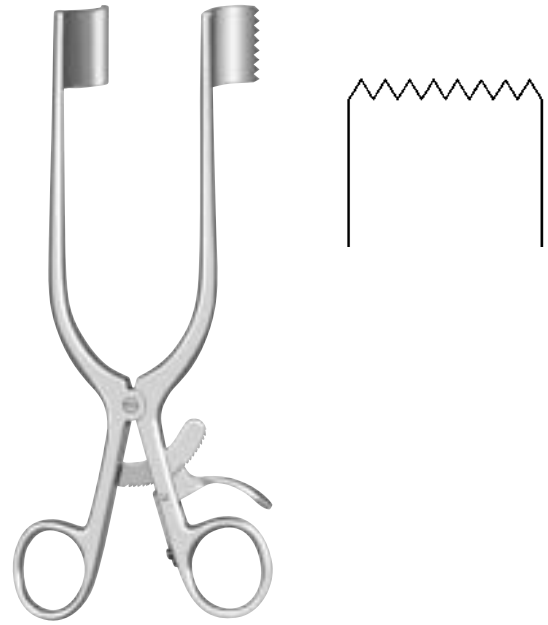

Sharp blades
OM 55-0430 57mm depth X 25mm height
OM 55-0431 51mm depth X 25mm height
OM 55-0432 41mm depth X 25mm height

MEYERDING LAMINECTOMY RETRACTOR
6 1/2" (165mm)



Left
OM 52-0554 50mm X 20mm blade
OM 52-0556 60mm X 20mm blade
OM 52-0558 70mm X 20mm blade
OM 52-0560 80mm X 20mm blade
OM 52-0562 90mm X 20mm blade
OM 52-0564 100mm X 20mm blade
OM 52-0566 110mm X 20mm blade

Right
OM 52-0574 50mm X 20mm blade
OM 52-0576 60mm X 20mm blade
OM 52-0578 70mm X 20mm blade
OM 52-0580 80mm X 20mm blade
OM 52-0582 90mm X 20mm blade
OM 52-0584 100mm X 20mm blade
OM 52-0586 110mm X 20mm blade

WILLIAMS HEMILAMINECTOMY RETRACTOR

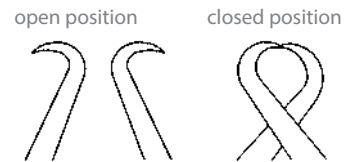

Designed to aid in the removal of interdigital neuroma.

Tips overlap in closed position making insertion and removal of retractor easier.

Provides excellent visibility of neuroma when retractor is in open position.

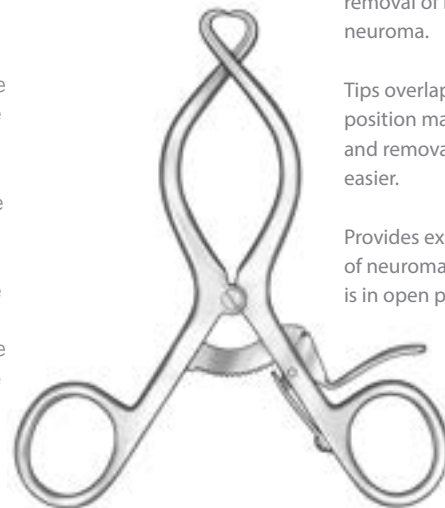

OM 52-0782 5 1/2" (140mm) sharp

JOHNSON NEUROMA RETRACTOR

SELF-RETAINING RETRACTORS

Note:

Deeper blades available upon special order.

Used primarily for hip procedures.



OM 52-0704
4 sharp prongs
stainless steel
maximum retraction width:
9 3/4" (247mm)
prong depth: 1" (25mm)
blade width: 1" (25mm)
weight: 3 lbs.

OM 52-0704W
Weight and chain only

OM 52-0704F
Frame only

Other blades available:
Prongs Depth X Blade Width
1 1/2" x 1" (25mm x 38mm)
1" x 1 3/4" (25mm x 38mm)
1" x 1" (25mm X 25mm)
2" x 1" (51mm X 25mm)
2 1/4" x 1" (57mm X 25mm)
2 1/2" x 1" (64mm X 25mm)
3" x 1" (76mm X 25mm)
4" x 1" (102mm X 25mm)
5" x 1" (127mm X 25mm)

Short Blade
OM 52-0703S
OM 52-0704S
OM 52-0705S
OM 52-0706S
OM 52-0707S
OM 52-0708S
OM 52-0709S
OM 52-0711S

Long Blade
OM 52-0703L
OM 52-0704L
OM 52-0705L
OM 52-0706L
OM 52-0707L
OM 52-0708L
OM 52-0709L
OM 52-0711L

INITIAL INCISION RETRACTOR



Prongs Depth X Blade Width
2" X 1" (51mm X 25mm)
2 1/2" X 1" (64mm X 25mm)
4" X 1" (102mm X 25mm)
5" X 1" (127mm X 25mm)

Short Blade
OM 52-0705SR
OM 52-0707SR
OM 52-0709SR
OM 52-0711SR

SHORT ROUND BLADES AVAILABLE



Prongs Depth X Blade Width Long Blade
2 1/4" X 1" (57mm X 25mm) OM 52-0706LR
4" X 1" (102mm X 25mm) OM 52-0709LR

LARGE ROUND BLADES AVAILABLE

Note:

For OM 48-0217, originally designed as a Lamina Spreader. Also very useful in hand, foot and knee procedures. Available with or without teeth.



OM 48-0215 Small
7" (178mm) STR

VERTEBRAL BODY DISTRACTOR



OM 48-0217 6 1/2" (165mm) with teeth
OM 48-0230 9 1/2" (241mm) with teeth
OM 48-0218 6 1/2" (165mm) without teeth

INGE RETRACTOR

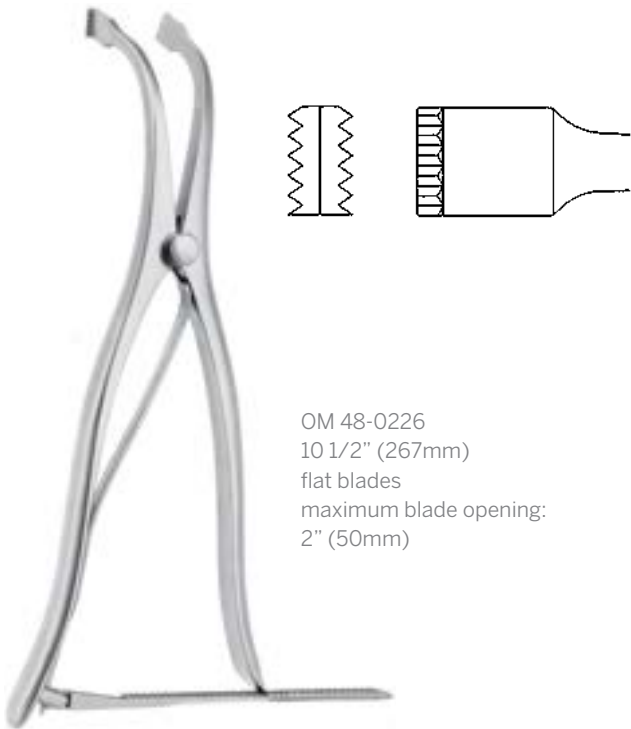

OM 48-0226
10 1/2" (267mm)
flat blades
maximum blade opening:
2" (50mm)

LAMINA SPREADER

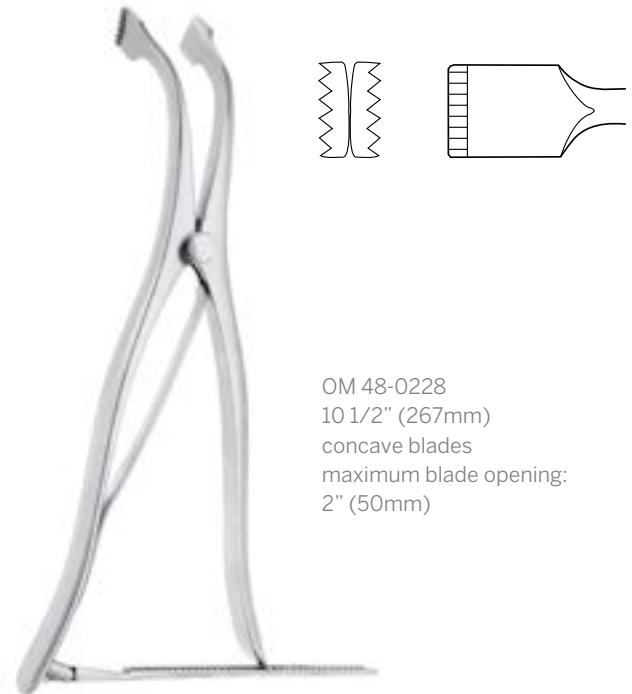

OM 48-0228
10 1/2" (267mm)
concave blades
maximum blade opening:
2" (50mm)

LAMINA SPREADER

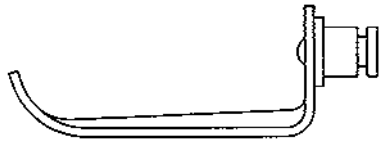
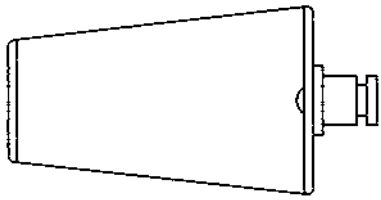

Set includes:

- OM 55-0481 Cervical retractor body, small, 6" (152mm)
- OM 55-0482 25mm blade depth
- OM 55-0483 30mm blade depth
- OM 55-0484 35mm blade depth
- OM 55-0485 40mm blade depth
- OM 55-0486 45mm blade depth
- OM 55-0487 50mm blade depth
- OM 55-0488 55mm blade depth

OM 55-0480
7 pairs of blunt blades and body

CERVICAL RETRACTOR SET



OM 55-0492

CERVICAL LAMINA SPREADER
3 3/4" Deep 3mm Tip



OM 55-0490 #1 with ratchet
5" (127mm)
spread: 3/4" (19mm)

VERTEBRA SPREADER

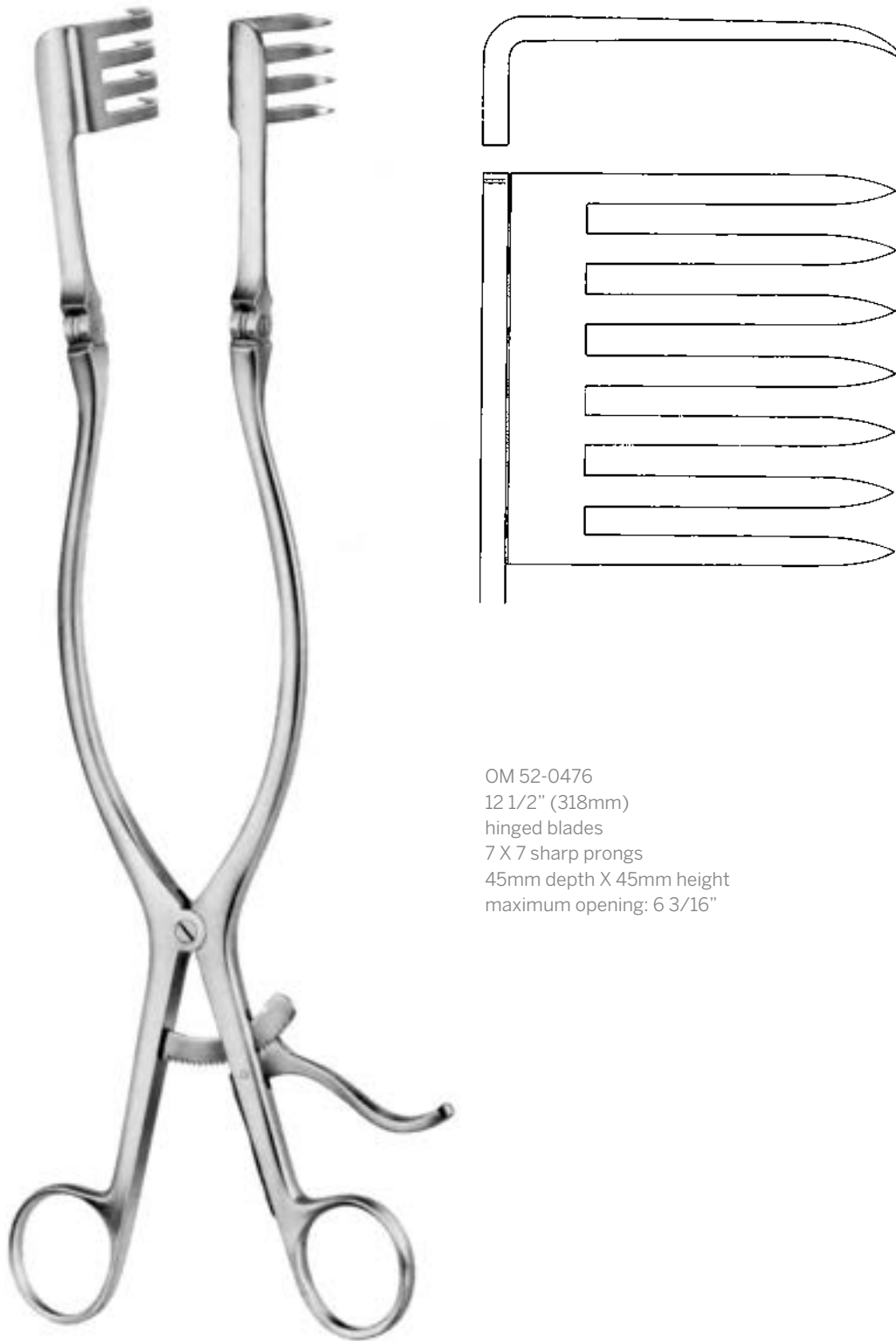

OM 52-0476
12 1/2" (318mm)
hinged blades
7 X 7 sharp prongs
45mm depth X 45mm height
maximum opening: 6 3/16"

BECKMAN-EATON RETRACTOR

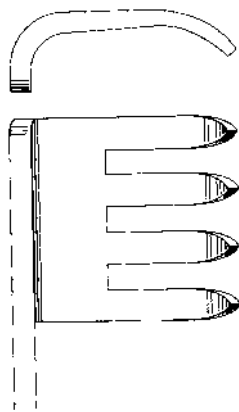
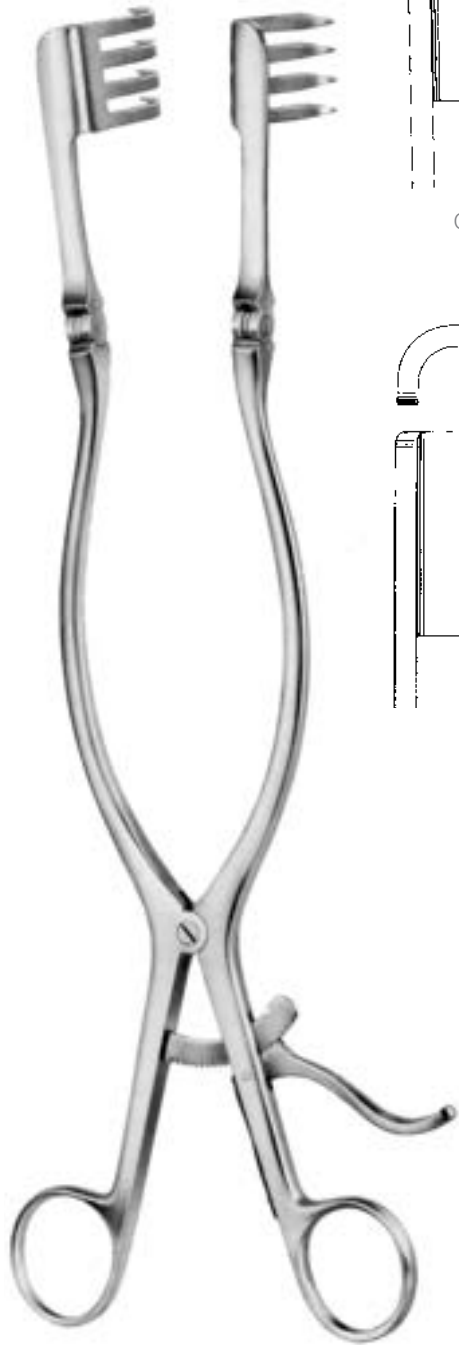

OM 52-0490

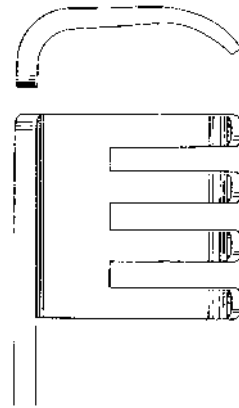

OM 52-0484

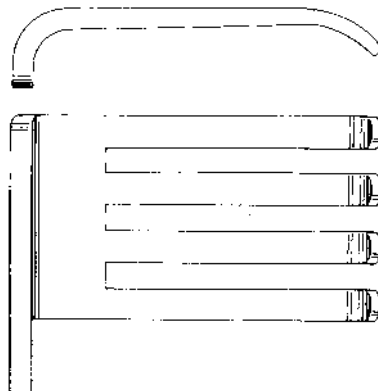

OM 52-0488

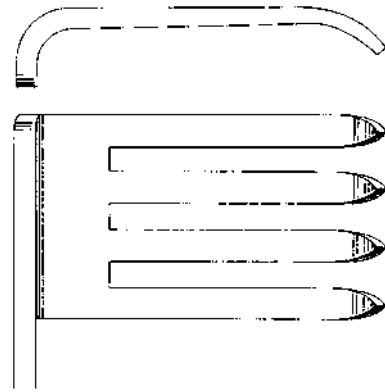

OM 52-0486

Sharp

4 X 4 prongs

OM 52-0490 25mm depth X 25mm height

OM 52-0486 44mm depth X 25mm height

maximum opening: 5 11/16" (145mm)

Blunt

4 X 4 prongs

OM 52-0484 25mm depth X 25mm height

OM 52-0488 44mm depth X 25mm height

maximum opening: 6" (152mm)

BECKMAN-ADSON LAMINECTOMY RETRACTOR

12 1/4" (311mm) with hinged blades

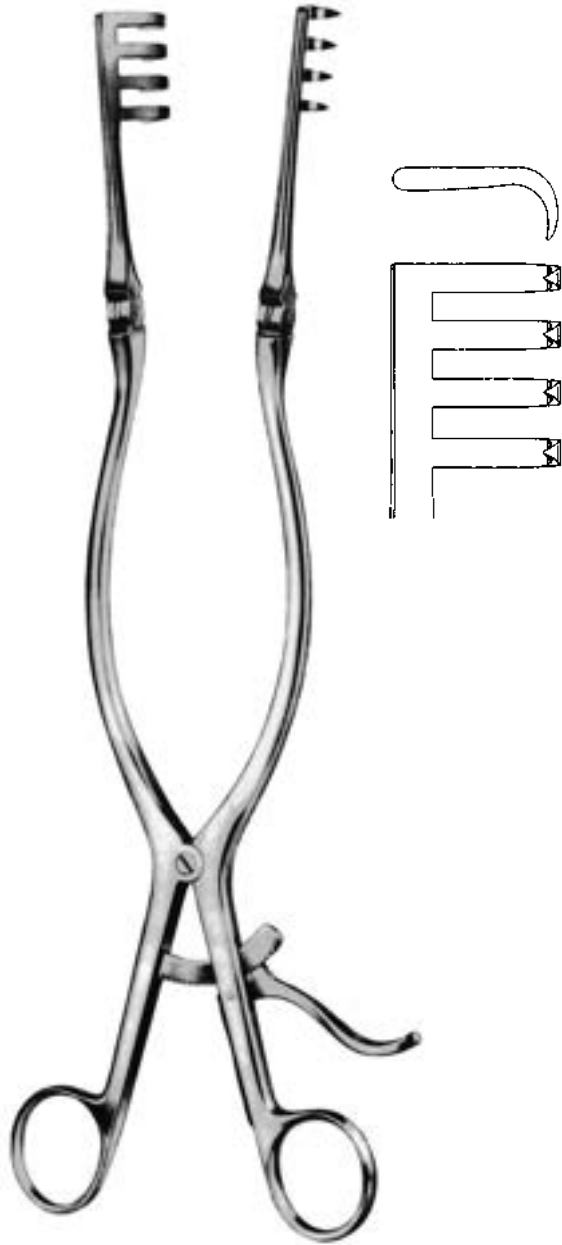

OM 52-0470
12 1/4" (311mm)
with hinged blades
4 X 4 with sharp prongs
17mm depth X 27mm height
maximum opening: 6 7/16"

OM 52-0472
12 1/4" (311mm)
with hinged blades
4 X 4 with blunt prongs
17mm depth X 27mm height
maximum opening: 6 7/16"

BECKMAN RETRACTOR

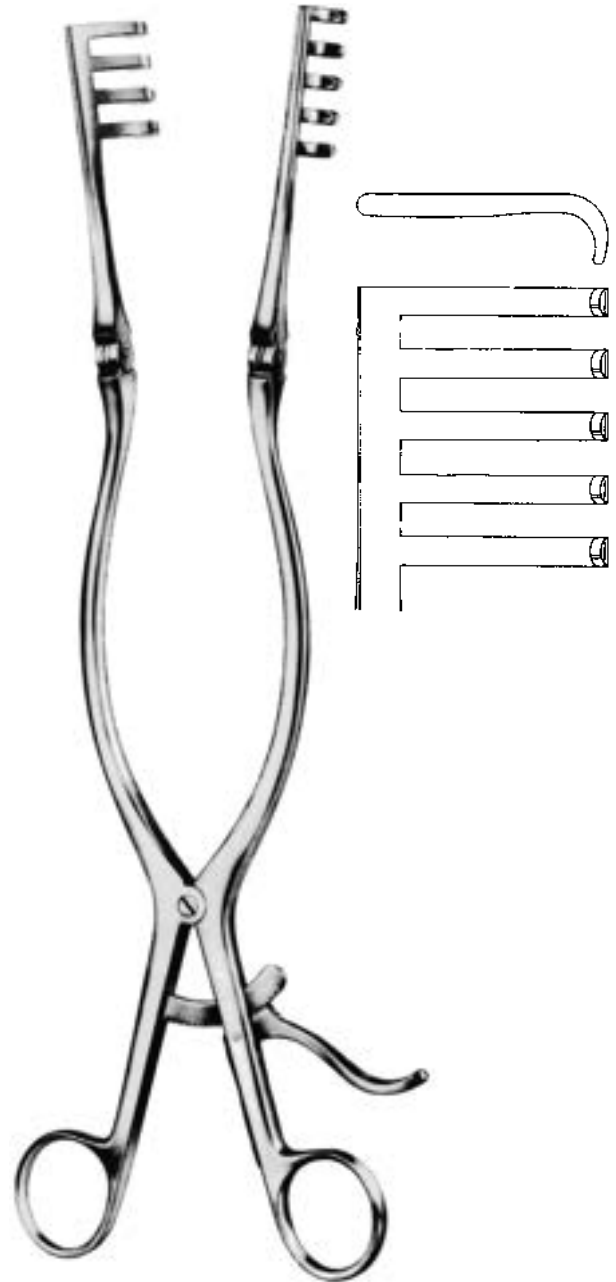

OM 52-0474
12 1/2" (318mm)
with hinged blades
4 X 5 with blunt prongs
25mm depth X 37mm height
maximum opening: 6 15/16"

ADSON RETRACTOR

SELF-RETAINING RETRACTORS

Primarily used to retract detached trochanter from the stump of the femoral neck. Hinged arms allow handles to be angled away from surgical site to minimize interference.

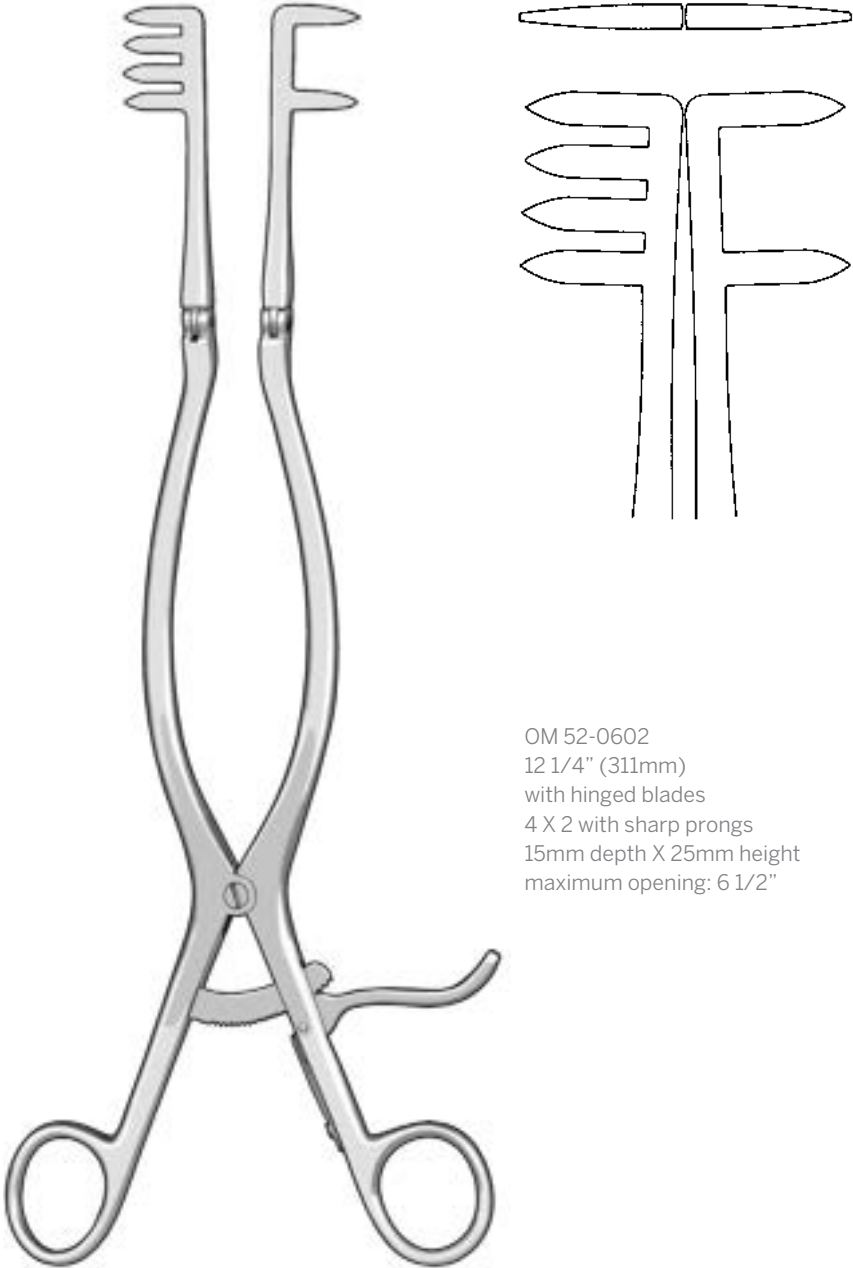

OM 52-0602
12 1/4" (311mm)
with hinged blades
4 X 2 with sharp prongs
15mm depth X 25mm height
maximum opening: 6 1/2"

HORIZONTAL RETRACTOR

OM 52-0380
3 1/2" (89mm) spread
fenestrated

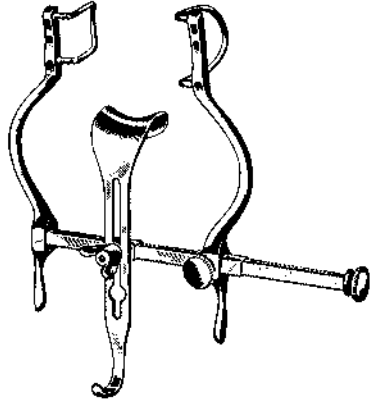

BALFOUR RETRACTOR
Pediatric

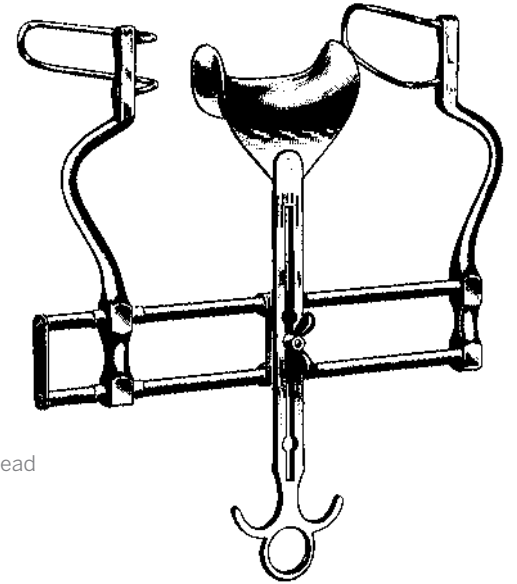

OM 52-0358
7" (178mm) spread
fenestrated

BALFOUR RETRACTOR
Adult

OM 58-0240
4 1/2" (114mm)

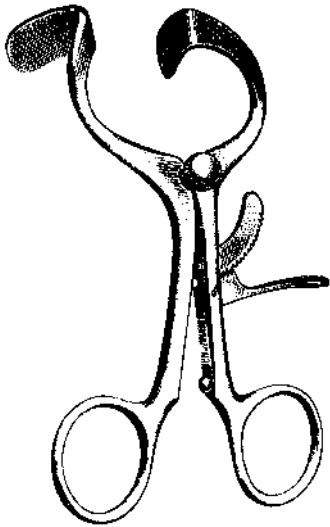

MALTZ-SEEBURGER RETRACTOR

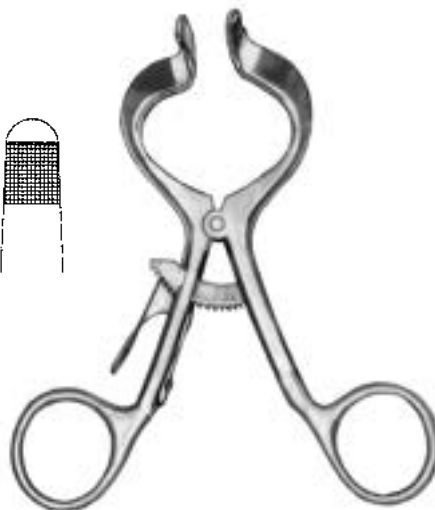
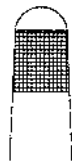

COX METATARSAL SPREADER

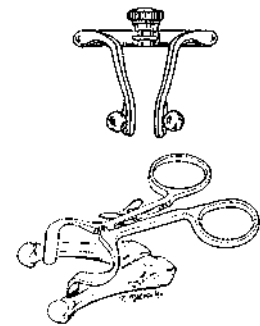

OM 69-0990
4 1/2" (114mm)
8mm width X 28mm depth
blades

Note:

- Specially designed thin serrated blades fit anatomically correct against the metatarsals.
- Precise design and German manufacture assure slip-proof hold on metatarsals.
- Affords excellent visibility for the surgeon.
- Designed by Dr. Kenneth Cox.

SELF-RETAINING RETRACTORS



SCOVILLE HEMILAMINECTOMY RETRACTOR BODY

OM 55-0445
spread: 6 3/4" (172mm)
arm length: 5 1/2" (140mm)



HAVERFIELD-SCOVILLE HEMILAMINECTOMY RETRACTOR BODY

OM 55-0446
spread: 7 1/4" (184mm)
arm length: 5 3/4" (146mm)
hinged

SCOVILLE BLADES

Hook style
OM 55-0447 2" depth (51mm)
OM 55-0448 3" depth (76mm)
OM 55-0449 2" depth (51mm), with cross bar
OM 55-0450 2 3/4" depth (70mm), with cross bar



SCOVILLE BLADES

Solid
OM 55-0451 1" width X 2 1/2" depth (25mm X 64mm)
OM 55-0452 2" width X 2 1/2" depth (51mm X 64mm)
OM 55-0453 1 1/8" width X 2 5/8" depth (29mm X 67mm)
OM 55-0454 1" width X 3 1/2" depth (25mm X 89mm)



SCOVILLE BLADES

4 prong
OM 55-0456 1 1/2" width X 1 5/8" depth (38mm X 41mm)
OM 55-0457 1 7/8" width X 2 5/8" depth (48mm X 67mm)



MEYERDING BLADES

OM 55-0458 1" width X 2 1/4" depth (25mm X 57mm)
OM 55-0459 1" width X 3" depth (25mm X 76mm)
OM 55-0460 2" width X 3 1/2" depth (51mm X 89mm)



HIBBS BLADES

OM 55-0461 1" width X 2" depth (25mm X 51mm)
OM 55-0462 2" width X 2" depth (51mm X 51mm)
OM 55-0463 1" width X 2 1/2" depth (25mm X 64mm)
OM 55-0464 1 1/2" width X 2 1/2" depth (38mm X 64mm)
OM 55-0465 1" width X 3" depth (25mm X 76mm)
OM 55-0466 1 1/2" width X 3" depth (38mm X 76mm)
OM 55-0467 2" width X 3" depth (51mm X 76mm)
OM 55-0468 1" width X 4" depth (25mm X 102mm)
OM 55-0469 2" width X 4" depth (51mm X 102mm)



TAYLOR SPINAL BLADES

OM 55-0471 1 1/4" width X 3" depth (32mm X 76mm)
 OM 55-0472 1 1/4" width X 4" depth (32mm X 102mm)



TAYLOR LAMINECTOMY BLADES

3 prong
 OM 55-0473 1 1/2" width X 1 3/4" depth (38mm X 44mm)



TAYLOR LAMINECTOMY BLADES

4 prong
 OM 55-0474 2" width X 1 7/8" depth (51mm X 48mm)
 OM 55-0475 2 1/2" width X 2 1/2" depth (64mm X 64mm)
 OM 55-0476 2 1/4" width X 3 1/8" depth (57mm X 79mm)

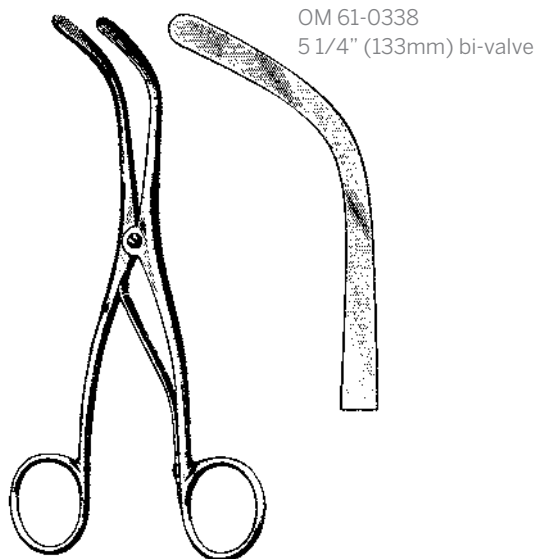

TROSSEAU DILATOR

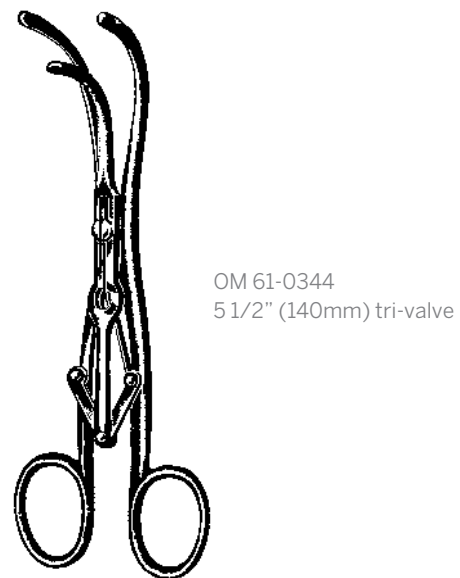

LA BORDE DILATOR



OM KO 7248-38 4cm deep prongs
OM KO 7248-40 7cm deep prongs
OM KO 7248-50 10cm deep prongs

SCOLIOSIS OR TOTAL HIP RETRACTOR

11 3/4" (30cm)



OM 52-0773 3" deep
OM 52-0774 4" deep
OM 52-0775 5" deep

SPINE RETRACTOR

90 degree retractor with speed lock, 5" exposure



OM 94-0100
12 1/4"
w/2 teeth

MCBRIDE SPINAL RETRACTOR



OM 52-0792 90° 3 1/2" deep
OM 52-0794 90° 3" deep
OM 52-0795 90° 4" deep
OM 52-0793 45° 3 1/2" deep

DEEP ANGLE RETRACTOR

cerebellar tips

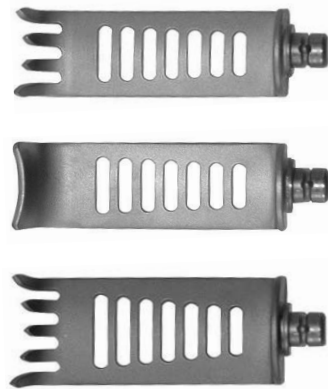

CCR BLADES

4 teeth medial/lateral, titanium, green

OM 96-0200	19mm	25mm
OM 96-0201	19mm	30mm
OM 96-0202	19mm	35mm
OM 96-0203	19mm	40mm
OM 96-0204	19mm	45mm
OM 96-0205	19mm	50mm
OM 96-0206	19mm	55mm
OM 96-0207	19mm	60mm
OM 96-0208	19mm	65mm
OM 96-0209	19mm	70mm
OM 96-0210	19mm	75mm

blunt longitudinal, titanium, green

OM 96-0211	19mm	25mm
OM 96-0212	19mm	30mm
OM 96-0213	19mm	35mm
OM 96-0214	19mm	40mm
OM 96-0215	19mm	45mm
OM 96-0216	19mm	50mm
OM 96-0217	19mm	55mm
OM 96-0218	19mm	60mm
OM 96-0219	19mm	65mm
OM 96-0220	19mm	70mm
OM 96-0221	19mm	75mm

8 teeth lateral, titanium, blue

OM 96-0222	24mm	25mm
OM 96-0223	24mm	30mm
OM 96-0224	24mm	35mm
OM 96-0225	24mm	40mm
OM 96-0226	24mm	45mm
OM 96-0227	24mm	50mm
OM 96-0228	24mm	55mm
OM 96-0229	24mm	60mm
OM 96-0230	24mm	65mm
OM 96-0231	24mm	70mm
OM 96-0232	24mm	75mm

5 teeth medial, titanium, blue

OM 96-0233	24mm	25mm
OM 96-0234	24mm	30mm
OM 96-0235	24mm	35mm
OM 96-0236	24mm	40mm
OM 96-0237	24mm	45mm
OM 96-0238	24mm	50mm
OM 96-0239	24mm	55mm
OM 96-0240	24mm	60mm
OM 96-0241	24mm	65mm
OM 96-0242	24mm	70mm
OM 96-0243	24mm	75mm

blunt longitudinal, titanium, blue

OM 96-0244	24mm	25mm
OM 96-0245	24mm	30mm
OM 96-0246	24mm	35mm
OM 96-0247	24mm	40mm
OM 96-0248	24mm	45mm
OM 96-0249	24mm	50mm
OM 96-0250	24mm	55mm
OM 96-0251	24mm	60mm
OM 96-0252	24mm	65mm
OM 96-0253	24mm	70mm
OM 96-0254	24mm	75mm



Casper Cervical Retractor basic counter retractor, double hinge, distal hinge titanium, radiolucent.

SPINE RETRACTOR

8" (203mm)
OM 96-0169



OM 96-0139 right body 2 1/2" spread
OM 96-0140 right body 3 1/4" spread, long bar
OM 96-0147 right drill guide black Radel handle

CASPER DISTRACTOR RIGHT



OM 96-0137 left body 2 1/2" spread
OM 96-0136 left body 3 1/4" spread, long bar
OM 96-0146 left drill guide black Radel handle

CASPER DISTRACTOR LEFT



SELF-RETAINING RETRACTORS

OM 96-0162 5 3/4" (146mm), 8mm depth
OM 96-0160 5 3/4" (146mm), 14mm depth



TWIST DRILL FOR DISTRACTION SCREWS

1.7mm diameter

OM 96-0150 with black Radel handle



OM 96-0156 12mm
OM 96-0157 14mm
OM 96-0158 16mm
OM 96-0159 18mm

SCREWDRIVER FOR DISTRACTION SCREWS

8" (203mm)

DISTRACTION SCREWS

non sterile

Note:

To add Fiberoptic Light, add "L" to the product number.
 To add Suction, add "S" to the product number.
 To add Fiberoptic and Suction, add "LS" to the product number.
 To add Endoscopic Sheath, add "E" to the product number.

Note: Each OrthoMed Endo-Retractor can be fitted with fiberoptic light and with suction. When intended for use with an endoscope, the Endo-Retractor will have the appropriate endoscope sheath mounted to it. OrthoMed Endo-Retractors feature UNIVERSAL light cord adapters that are compatible with Storz®, Wolf®, ACMI®, Olympus®, and most other fittings.



Shown with suction and fiberoptic light.

OM MA 110-681	30.0mm X 9.0cm
OM MA 110-682	24.0mm X 9.0cm
OM MA 110-683	36.0mm X 16.0cm
OM MA 110-684	36.0mm X 19.0cm
OM MA 110-685	25.0mm X 10.0cm
OM MA 110-686	25.0mm X 12.0cm
OM MA 110-687	30.0mm X 12.0cm
OM MA 110-688	25.0mm X 15.0cm
OM MA 110-689	30.0mm X 15.0cm
OM MA 110-690	16.0mm X 8.0cm

TEBBETTS STYLE

FIBEROPTIC RETRACTORS

Note:

- To add Fiberoptic Light, add "L" to the product number.
 - To add Suction, add "S" to the product number.
 - To add Fiberoptic and Suction, add "LS" to the product number.
 - To add Endoscopic Sheath, add "E" to the product number.
-



Shown with suction and fiberoptic light.

OM MA 110-671	14.0mm X 7.0cm
OM MA 110-672	14.0mm X 9.0cm
OM MA 110-673	23.0mm X 15.0cm
OM MA 110-674	23.0mm X 18.0cm

FERRIERA STYLE

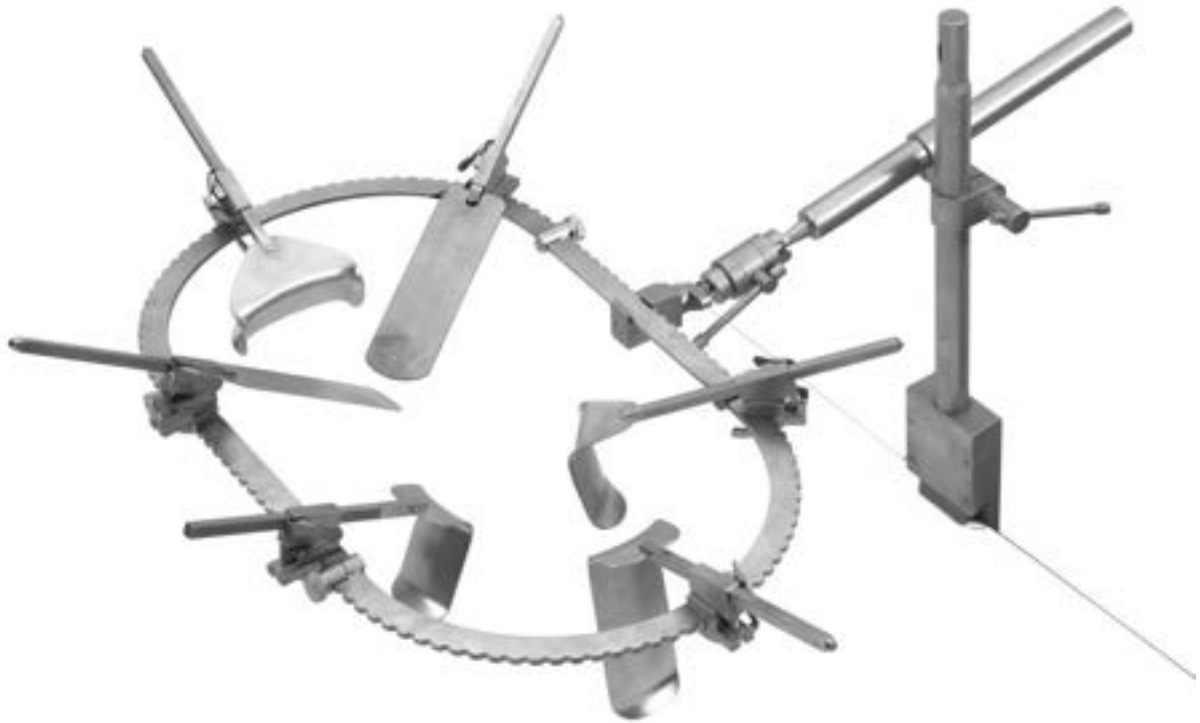

Complete set.
OM MA 110-701

Set includes:

- | | |
|----------------|--|
| OM COD 50-4581 | Table Post |
| OM COD 50-4552 | Horizontal Bar |
| OM COD 50-4554 | 1" Post Coupling |
| OM COD 50-4557 | Medium Oval Ring |
| OM COD 50-4561 | 2" x 6" (51mm X 152mm) Malleable Retractor (2 ea.) |
| OM COD 50-4568 | 2" x 3" (51mm X 76mm) Kelly Retractor (2 ea.) |
| OM COD 50-4569 | 2" x 4" (51mm X 102mm) Kelly Retractor |
| OM COD 50-4576 | Balfour Retractor |
| OM COD 50-4579 | Ratchet Mechanism (2 ea.) |
| OM COD 50-4580 | Tilt Ratchet Mechanism (6 ea.) |
| OM COD 50-4583 | Segmented Ring |
| OM COD 50-4562 | 1 1/2" x 6" (38mm X 152mm) Malleable Retractor |
| OM COD 50-4567 | 3" x 6" (76mm X 152mm) Malleable Retractor |
| OM COD 50-4570 | 2" x 5" (51mm X 127mm) Kelly Retractor |
| OM COD 50-4571 | 2" x 6" (51mm X 152mm) Kelly Retractor |
| OM COD 50-4582 | Horizontal Flex Bar |
| OM COD 50-4566 | Harrington Retractor |
| OM COD 50-4577 | Gelpi Retractor |

Accessories:

- | | |
|---------------|------------------------------|
| OM MA 110-760 | Table Fixation and Ring Case |
| OM MA 110-770 | Blades and Accessories Case |

MULTI TRAC RETRACTOR SET



- OM COD 50-4584 10 1/2" (267mm) round ring
- OM COD 50-4557 10 1/2" x 14 1/2" (267mm X 495mm) oval ring
- OM COD 50-4583 10 1/2" x 19 1/2" (267mm X 368mm) segmented ring

RETRACTOR RINGS



- OM COD 50-4554 1" (25mm) post coupler
- OM COD 50-4581 Table post
- OM COD 50-4552 Horizontal bar
- OM COD 50-4582 Horizontal flex bar

TABLE MOUNTING COMPONENTS

Allows extension or retraction along the horizontal axis and allows vertical movement of retractor blade with a second ratchet.



TILT RATCHET MECHANISM
OM COD 50-4580

Allows extension or retraction along the horizontal axis at 2mm intervals



FIXED RATCHET MECHANISM
OM COD 50-4579



- OM COD 110-834 2 1/2" x 3" (64mm X 76mm) blades
- OM COD 50-4568 2" x 3" (51mm X 76mm) blades
- OM COD 50-4569 2" x 4" (51mm X 102mm) blades
- OM COD 50-4570 2" x 5" (51mm X 127mm) blades

KELLY BLADES



- OM COD 110-837 2 1/2" x 10" (64mm X 254mm) blades
- OM COD 50-4571 2" x 6" (51mm X 152mm) blades
- OM COD 110-836 2 1/2" x 8" (64mm X 203mm) blades



- OM COD 110-811 1" x 5" (25mm X 127mm)
- OM COD 110-812 1" x 6" (25mm X 152mm)
- OM COD 110-813 6" x 12" (152mm X 305mm)
- OM COD 110-814 1" x 9" (25mm X 229mm)
- OM COD 110-815 2" x 7" (51mm X 178mm)
- OM COD 110-816 3" x 7" (76mm X 178mm)
- OM COD 110-817 2" x 9" (51mm X 229mm)
- OM COD 110-818 2" x 12" (51mm X 305mm)
- OM COD 110-819 3" x 10" (76mm X 254mm)
- OM COD 110-820 3" x 12" (76mm X 305mm)
- OM COD 110-821 4" x 10" (102mm X 254mm)
- OM COD 110-822 4" x 12" (102mm X 305mm)
- OM COD 110-823 6" x 9" (152mm X 229mm)

MALLEABLE RETRACTORS WITH PROTECTIVE EDGE



- OM COD 50-4576 Balfour blade
- OM COD 110-848 Malleable 1/2" x 3" (13mm X 76mm) with lip
- OM COD 50-4577 Gelpi Retractor

SPECIALTY RETRACTORS



The many components of the Multi Trac retractor set can all be neatly arranged into autoclave sized containers with diagrams that direct instrument handlers on proper placement of each component. A major convenience in care and maintenance of the retractor set.

BLADE AND ACCESSORIES CASE

OM MA 110-770

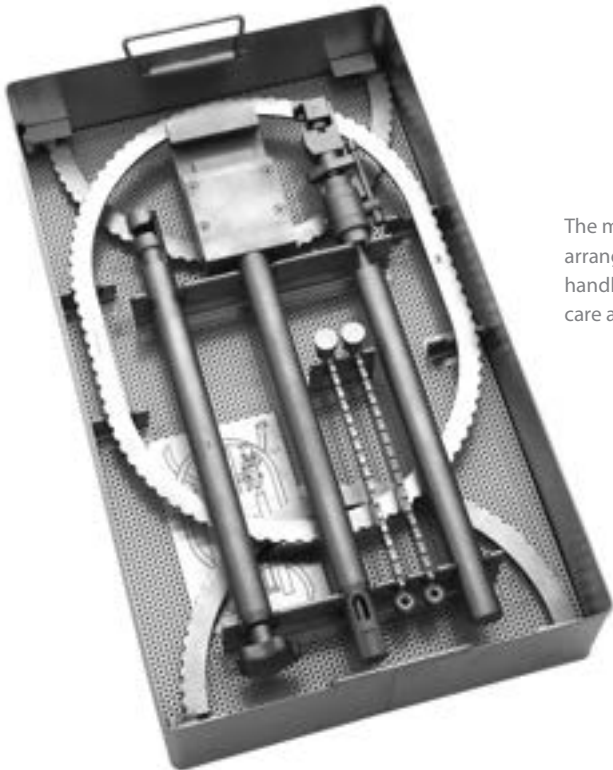

The many components of the Multi Trac retractor set can all be neatly arranged into autoclave sized containers with diagrams that direct instrument handlers on proper placement of each component. A major convenience in care and maintenance of the retractor set.

TABLE FIXATION AND RING CASE

OM MA 110-760

Thin pads help to separate the femur and tibia during total knee replacement surgery.



OM 90-1875
9 1/4" Pads 22mm X 13mm
Opens to 50mm
with horizontal cut pads

OM 90-1876
7" Pads 22mm X 13mm
Opens to 35mm
with horizontal cut pads

FEMORAL TIBIAL SPREADER

OM 90-1866 10" (254mm) Round disks
OM 90-1865 7" (178mm) Round disks

FEMORAL TIBIAL SPREADER



OM 90-1880 7" (178mm) Smooth pads 15mm x 12mm
OM 90-1881 7" (178mm) Grooved pads 15mm x 12mm

CALCANEAL SPREADER



RETRACTOR



OM 90-1875D
Diamond cut pads 10" (254mm)

OM 90-1876D
Diamond cut pads 7" (178mm)

FEMORAL TIBIAL SPREADER



Long prongs allow use in small, but deep wounds.

Maximum opening: 32mm

OM 90-5065	3 X 2 blunt prongs	Blade depth 25mm
OM 90-5066	3 X 2 sharp prongs	Blade depth 25mm
OM 90-5067	3 X 2 blunt prongs	Blade depth 30mm
OM 90-5068	3 X 2 sharp prongs	Blade depth 30mm

DEEP BLADE SMALL WEITLANER RETRACTOR

4 1/2"



OM NL 9701 (retractor only)
OM NL9701-H (Hinged)
OM NL 9702-01 (full set) with hinged retractor and case



MCCULLOCH RETRACTOR

MCCULLOCH RETRACTOR

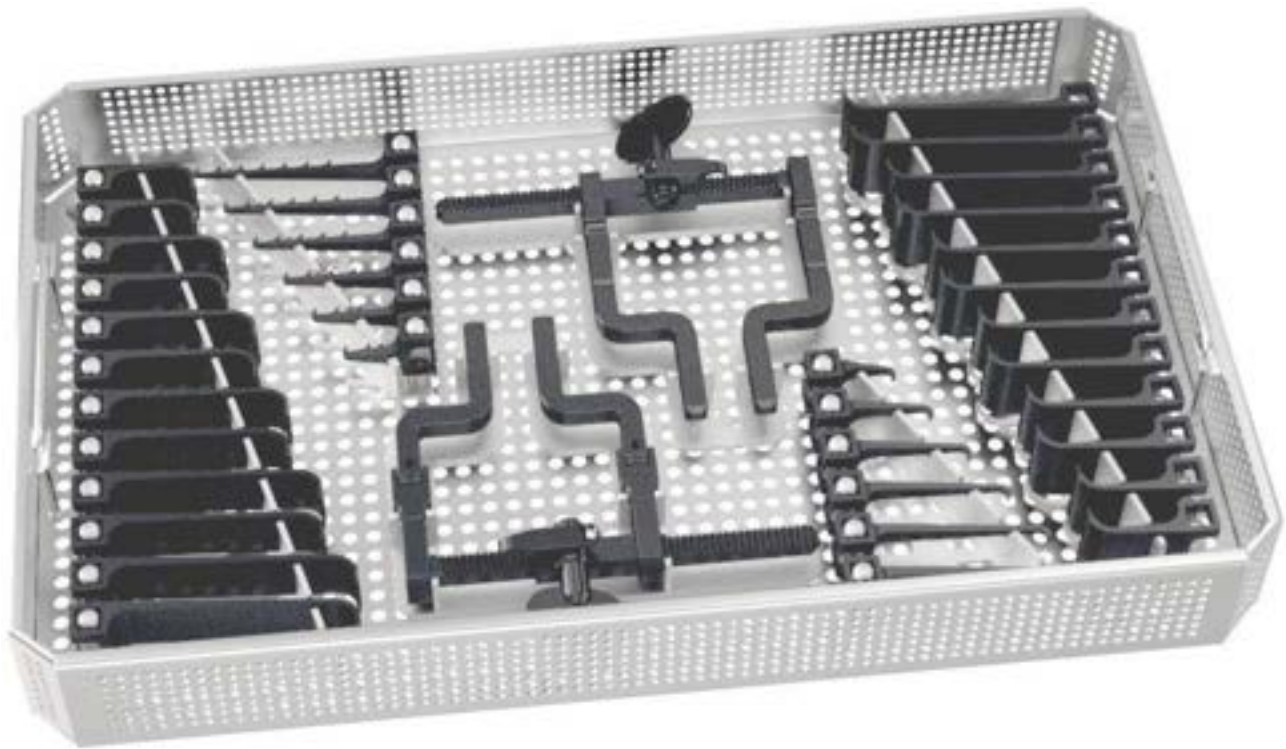

OM NL 9701	McCulloch Retractor Body	Rigid
OM NL 9701-H	McCulloch Retractor Body	Hinged Arms
OM NL 9702-01	Full set McCulloch Retractor with Case	Rigid and Hinged
OM NL 9702-010	Wide Muscle Blade	30x27mm
OM NL 9702-011	Wide Muscle Blade	40x27mm
OM NL 9702-012	Wide Muscle Blade	50x27mm
OM NL 9702-013	Wide Muscle Blade	60x27mm
OM NL 9702-014	Wide Muscle Blade	70x27mm
OM NL 9702-015	Wide Muscle Blade	80x27mm
OM NL 9702-020	Narrow Muscle Blade	30x20mm
OM NL 9702-021	Narrow Muscle Blade	40x20mm
OM NL 9702-022	Narrow Muscle Blade	50x20mm
OM NL 9702-023	Narrow Muscle Blade	60x20mm
OM NL 9702-024	Narrow Muscle Blade	70x20mm
OM NL 9702-025	Narrow Muscle Blade	80x20mm
OM NL 9702-026	Narrow Muscle Blade	90x20mm
OM NL 9702-030	Hook Blade	20mm
OM NL 9702-031	Hook Blade	30mm
OM NL 9702-032	Hook Blade	40mm
OM NL 9702-033	Hook Blade	50mm
OM NL 9702-034	Hook Blade	60mm
OM NL 9702-035	Hook Blade	70mm
OM NL 9702-036	Hook Blade	80mm
OM NL 9702-040	Tooth Blade	20mm
OM NL 9702-041	Tooth Blade	30mm
OM NL 9702-042	Tooth Blade	40mm
OM NL 9702-043	Tooth Blade	50mm
OM NL 9702-044	Tooth Blade	60mm
OM NL 9702-045	Tooth Blade	70mm

McCULLOCH RETRACTOR

OSTEOTOMES, CHISELS AND GOUGES



SECTION J

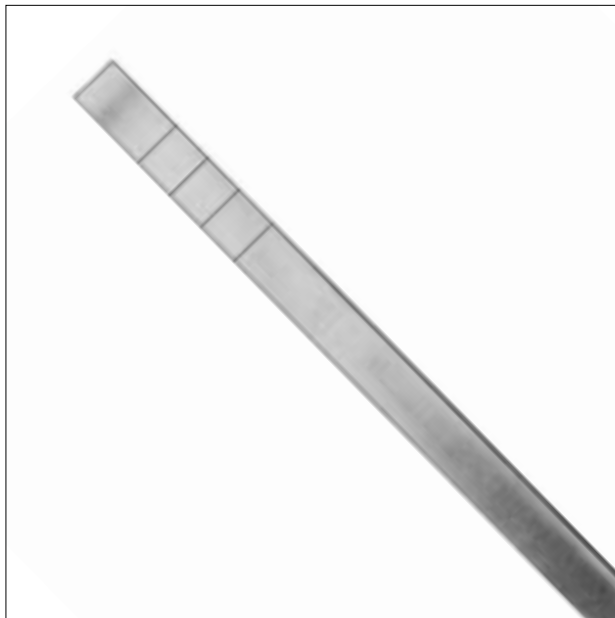

To score, cut, scrape, clean and sculpt bone.

CONTENTS

Interchangeable Set	1
Chisels	4-9
Gouges	5-12
Osteotomes	2-12



- OM 49-0668 5mm
- OM 49-0672 10mm
- OM 49-0676 16mm
- OM 49-0680 25mm

OSTEOTOME BLADES

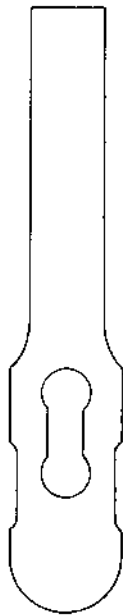

OM 49-0672

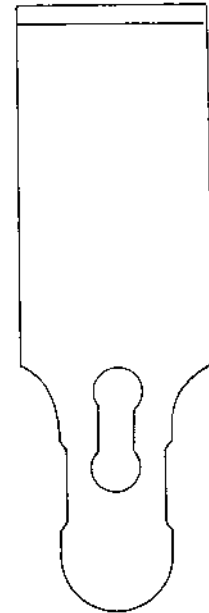

OM 49-0664

- OM 49-0652 5mm
- OM 49-0656 10mm
- OM 49-0660 16mm
- OM 49-0664 25mm

CHISEL BLADES



KEY
OM 49-0634

Phenolic handle is autoclavable to 290°F (143°C).

- OM 49-0630 complete set with handle, key and all blades
- OM 49-0632 7" black phenolic handle handpiece only

INTERCHANGEABLE OSTEOTOME, CHISEL AND GOUGE SET

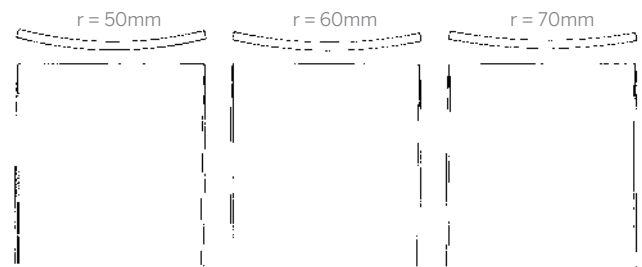

OM 49-0640

OM 49-0644







OM 49-0648

- OM 49-0640 1" width, 50mm radius
- OM 49-0644 1" width, 60mm radius
- OM 49-0648 1" width, 70mm radius

Blades should be discarded after use.

GOUGE BLADES

OSTEOTOMES, CHISELS AND GOUGES





4mm 6mm 8mm

10mm 12mm 15mm

5" Straight

OM 46-0337	2mm	OM 46-0343	14mm
OM 46-0336	4mm	OM 46-0345	15mm
OM 46-0338	6mm	OM 46-0346	18mm
OM 46-0340	8mm	OM 46-0347	19mm
OM 46-0342	10mm	OM 46-0335	20mm
OM 46-0344	12mm		

MINI-LAMBOTTE OSTEOTOME

10mm 20mm

The unusually long bevel allows the cut bone to bend gradually as it is cut.

7" Straight
With calibration lines

OM 69-0940	10mm	7" Curved With calibration lines	
OM 69-0946	20mm	OM 69-0970	5mm
OM 69-0950	25mm	OM 69-0975	10mm

LONG BEVEL OSTEOTOME







4mm 8mm 10mm 12mm 25mm

7" Straight
With calibration lines

OM 46-0348	4mm	7" Curved With calibration lines	OM 46-0348C	4mm
OM 46-0349	5mm		OM 46-0349C	5mm
OM 46-0350	6mm		OM 46-0350C	6mm
OM 46-0358	8mm		OM 46-0358C	8mm
OM 46-0351	10mm		OM 46-0351C	10mm
OM 46-0352	12mm		OM 46-0352C	12mm
OM 46-0353	16mm		OM 46-0353C	16mm
OM 46-0354	19mm		OM 46-0354C	19mm
OM 46-0355	22mm		OM 46-0355C	22mm
OM 46-0356	25mm		OM 46-0356C	25mm



LAMBOTTE OSTEOTOME

Racks for 9" Lambotte
Osteotomes are
shown on page AA2.

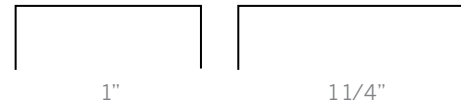

9" Straight Without calibration lines		
OM 46-0304	1/4"	6mm
OM 46-0306	1/2"	13mm
OM 46-0310	3/4"	19mm
OM 46-0314	1"	25mm
OM 46-0318	1 1/4"	32mm
OM 46-0322	1 1/2"	38mm

9" Curved Without calibration lines		
OM 46-0328	1/4"	6mm
OM 46-0329	1/2"	13mm
OM 46-0330	3/4"	19mm
OM 46-0331	1"	25mm
OM 46-0332	1 1/4"	32mm
OM 46-0333	1 1/2"	38mm

LAMBOTTE OSTEOTOME

Racks for Hoke Osteotomes
are shown on page AA3.

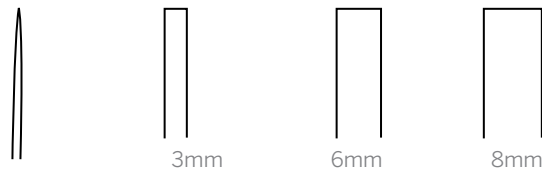

Straight		
OM 46-0497	1/8"	3mm
OM 46-0498	3/16"	4mm
OM 46-0499	1/4"	6mm
OM 46-0500	5/16"	8mm
OM 46-0501	3/8"	10mm
OM 46-0502	1/2"	13mm
OM 46-0503	5/8"	16mm
OM 46-0504	3/4"	19mm

Curved		
OM 46-0700	1/8"	3mm
OM 46-0701	3/16"	4mm
OM 46-0702	1/4"	6mm
OM 46-0703	5/16"	8mm
OM 46-0704	3/8"	10mm
OM 46-0706	1/2"	13mm
OM 46-0708	5/8"	16mm
OM 46-0709	3/4"	19mm

HOKE OSTEOTOME

5 1/4" (140mm) straight

OSTEOTOMES, CHISELS AND GOUGES

Racks for Hoke Chisels are shown in Section AA.

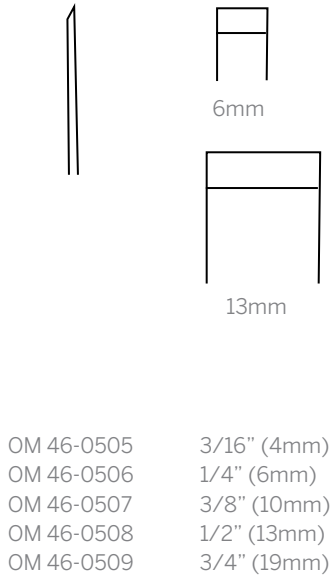

HOKE CHISEL

5 1/4" (133mm)
straight

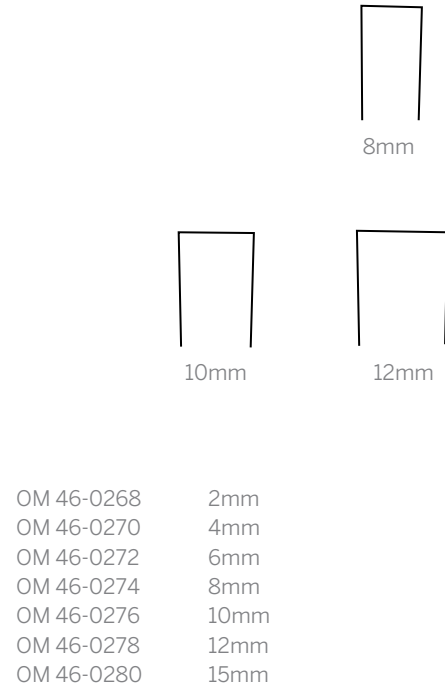

SHEEHAN OSTEOTOME

6 1/4" (159mm)
straight

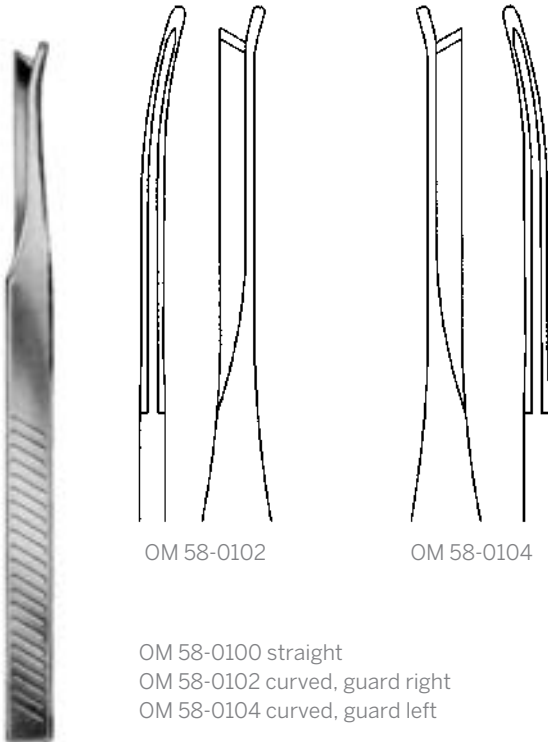

OM 58-0102 OM 58-0104

OM 58-0100 straight
OM 58-0102 curved, guard right
OM 58-0104 curved, guard left

SILVER OSTEOTOME

7" (178mm)
with single guard



OM 46-0284 6mm
OM 46-0286 12mm
OM 46-0288 18mm

U.S. ARMY PATTERN OSTEOTOME

7" (178mm)



6mm

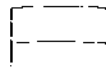

12mm

OM 46-0289 6mm
 OM 46-0290 12mm
 OM 46-0291 14mm

U.S. ARMY PATTERN CHISEL

7" (178mm)



6mm



12mm



14mm

OM 46-0292 6mm
 OM 46-0293 12mm
 OM 46-0294 14mm

U.S. ARMY PATTERN GOUGE

7" (178mm)



4mm



6mm



8mm



10mm

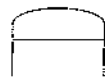

12mm



14mm

OM 49-0040 4mm
 OM 49-0041 6mm
 OM 49-0042 8mm
 OM 49-0043 10mm
 OM 49-0044 12mm
 OM 49-0045 14mm

ALEXANDER CHISEL

7" (178mm)



4mm



6mm



8mm



10mm



12mm

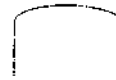

14mm

OM 49-0050 4mm
 OM 49-0051 6mm
 OM 49-0052 8mm
 OM 49-0053 10mm
 OM 49-0054 12mm
 OM 49-0055 14mm

ALEXANDER GOUGE

7" (178mm)

OSTEOTOMES, CHISELS AND GOUGES

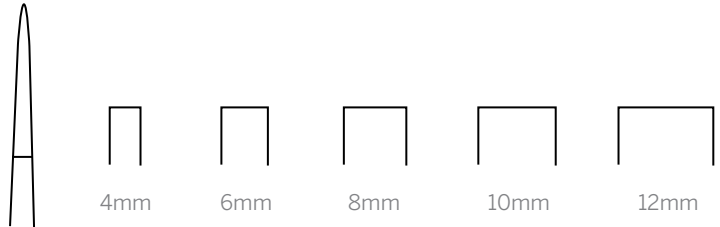

- OM 49-0260 4mm
- OM 49-0262 6mm
- OM 49-0264 8mm
- OM 49-0266 10mm
- OM 49-0268 12mm

LEXER MINI CHISEL
7" (178mm)

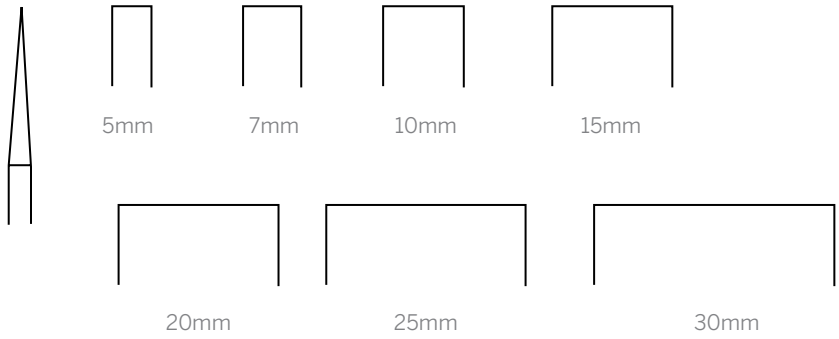

- OM 49-0246 5mm
- OM 49-0248 7mm
- OM 49-0250 10mm
- OM 49-0252 15mm
- OM 49-0254 20mm
- OM 49-0256 25mm
- OM 49-0258 30mm

LEXER CHISEL
8 3/4" (222mm)

Racks for Smith Peterson Osteotomes are shown in Section AA.



1/4"



1/2"



1"



8" Straight

OM 46-0448	1/4"	6mm
OM 46-0449	3/8"	10mm
OM 46-0450	1/2"	13mm
OM 46-0451	5/8"	16mm
OM 46-0452	3/4"	19mm
OM 46-0453	1"	25mm
OM 46-0454	1 1/4"	32mm

8" Curved

OM 46-0457	1/4"	6mm
OM 46-0458	3/8"	10mm
OM 46-0459	1/2"	13mm
OM 46-0460	5/8"	16mm
OM 46-0461	3/4"	19mm
OM 46-0462	1"	25mm
OM 46-0463	1 1/4"	32mm

SMITH PETERSON OSTEOTOME

Racks for Smith Peterson Gouges are shown in Section AA.



1/4"

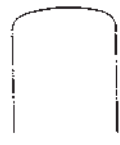

1/2"



3/4"



8" Straight

OM 46-0466	1/4"	6mm
OM 46-0467	3/8"	10mm
OM 46-0468	1/2"	13mm
OM 46-0476	5/8"	16mm
OM 46-0477	3/4"	19mm
OM 46-0478	1"	25mm
OM 46-0479	1 1/4"	32mm

8" Curved

OM 46-0487	1/4"	6mm
OM 46-0488	3/8"	10mm
OM 46-0489	1/2"	13mm
OM 46-0490	5/8"	16mm
OM 46-0491	3/4"	19mm
OM 46-0493	1"	25mm
OM 46-0495	1 1/4"	32mm

SMITH PETERSON GOUGE

OSTEOTOMES, CHISELS AND GOUGES



OM 49-0002 10mm
 OM 49-0004 14mm
 OM 49-0006 18mm
 OM 49-0008 22mm

STILLE-TYPE OSTEOTOME
 8" (203mm) straight



OM 49-0010 10mm
 OM 49-0012 14mm
 OM 49-0014 18mm
 OM 49-0016 22mm

STILLE-TYPE CHISEL
 8" (203mm) straight



OM 49-0018 10mm
 OM 49-0020 14mm
 OM 49-0022 18mm
 OM 49-0024 22mm

STILLE-TYPE GOUGE
 8" (203mm) straight

Racks for Hibbs Osteotomes are shown in Section AA.



1"



1 1/4"



9" (229mm) Straight

OM 46-0359 1/4" (6mm)
 OM 46-0360 3/8" (10mm)
 OM 46-0361 1/2" (13mm)
 OM 46-0362 5/8" (16mm)
 OM 46-0363 3/4" (19mm)
 OM 46-0364 7/8" (22mm)
 OM 46-0365 1" (25mm)
 OM 46-0366 1 1/8" (29mm)
 OM 46-0367 1 1/4" (31mm)
 OM 46-0368 1 1/2" (38mm)

9" (229mm) Curved

OM 46-0373 1/4" (6mm)
 OM 46-0376 3/8" (10mm)
 OM 46-0377 1/2" (13mm)
 OM 46-0378 5/8" (16mm)
 OM 46-0379 3/4" (19mm)
 OM 46-0380 7/8" (22mm)
 OM 46-0381 1" (25mm)
 OM 46-0382 1 1/8" (29mm)
 OM 46-0383 1 1/4" (31mm)
 OM 46-0384 1 1/2" (38mm)

HIBBS OSTEOTOME



Racks for Hibbs Chisel are shown in Section AA.

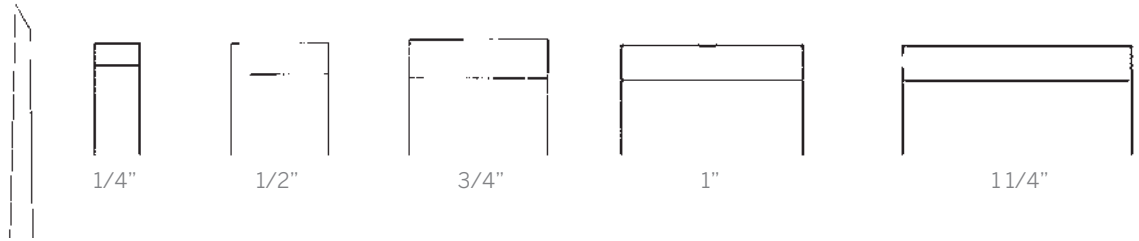

9" (229mm) Straight

OM 49-0059	1/4" (6mm)
OM 49-0060	3/8" (10mm)
OM 49-0061	1/2" (13mm)
OM 49-0062	5/8" (16mm)
OM 49-0063	3/4" (19mm)
OM 49-0064	7/8" (22mm)
OM 49-0065	1" (25mm)
OM 49-0066	1 1/8" (29mm)
OM 49-0067	1 1/4" (31mm)
OM 49-0068	1 1/2" (38mm)

9" (229mm) Curved

OM 49-0073	1/4" (6mm)
OM 49-0074	3/8" (10mm)
OM 49-0075	1/2" (13mm)
OM 49-0076	5/8" (16mm)
OM 49-0077	3/4" (19mm)
OM 49-0078	7/8" (22mm)
OM 49-0079	1" (25mm)
OM 49-0080	1 1/8" (29mm)
OM 49-0081	1 1/4" (31mm)
OM 49-0082	1 1/2" (38mm)

HIBBS CHISEL



Racks for Hibbs Gouge are shown in Section AA.

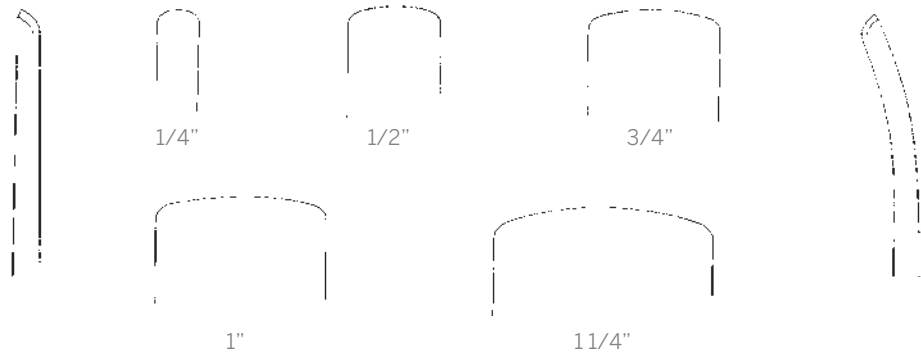

9" (229mm) Straight

OM 46-0387	1/4" (6mm)
OM 46-0388	3/8" (10mm)
OM 46-0389	1/2" (13mm)
OM 46-0390	5/8" (16mm)
OM 46-0391	3/4" (19mm)
OM 46-0392	7/8" (22mm)
OM 46-0393	1" (25mm)
OM 46-0394	1 1/8" (29mm)
OM 46-0395	1 1/4" (31mm)
OM 46-0401	1 1/2" (38mm)

9" (229mm) Curved

OM 46-0402	1/4" (6mm)
OM 46-0403	3/8" (10mm)
OM 46-0404	1/2" (13mm)
OM 46-0405	5/8" (16mm)
OM 46-0407	3/4" (19mm)
OM 46-0408	7/8" (22mm)
OM 46-0409	1" (25mm)
OM 46-0410	1 1/8" (29mm)
OM 46-0411	1 1/4" (31mm)
OM 46-0412	1 1/2" (38mm)

HIBBS GOUGE



3mm

OM 46-0919
8 1/2" (220mm)

SHOULDER PENETRATING GOUGE

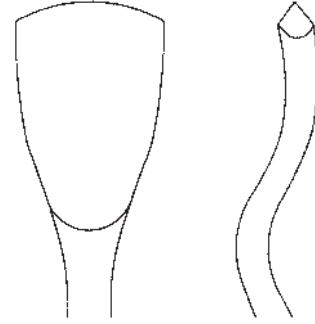

OM 49-0084
9" (229mm)

SWAN NECK GOUGE



1/4"



3/8"



1/2"



5/8"



3/4"



1"



1 1/4"



11" (280mm) Straight

OM 49-0350	1/4"	(6mm)
OM 49-0351	3/8"	(10mm)
OM 49-0352	1/2"	(13mm)
OM 49-0353	5/8"	(16mm)
OM 49-0354	3/4"	(19mm)
OM 49-0355	1"	(25mm)
OM 49-0356	1 1/4"	(31mm)
OM 46-0370	2"	(51mm)

11" (280mm) Curved

OM 49-0357	1/4"	(6mm)
OM 49-0358	3/8"	(10mm)
OM 49-0359	1/2"	(13mm)
OM 49-0360	5/8"	(16mm)
OM 49-0361	3/4"	(19mm)
OM 49-0362	1"	(25mm)
OM 49-0363	1 1/4"	(31mm)

COBB OSTEOTOME



OM 49-0030
straight
5/32" (7mm) blade width



OM 49-0032
medium curve
5/32" (7mm) blade width



OM 49-0034
strong curve
5/32" (7mm) blade width



OM 49-0036
reverse curve
5/32" (7mm) blade width

COBB-TYPE SPINAL GOUGE

11" (280mm)
All stainless, with knurled handle

Racks for Cobb-Type Gouges
are shown in Section AA.

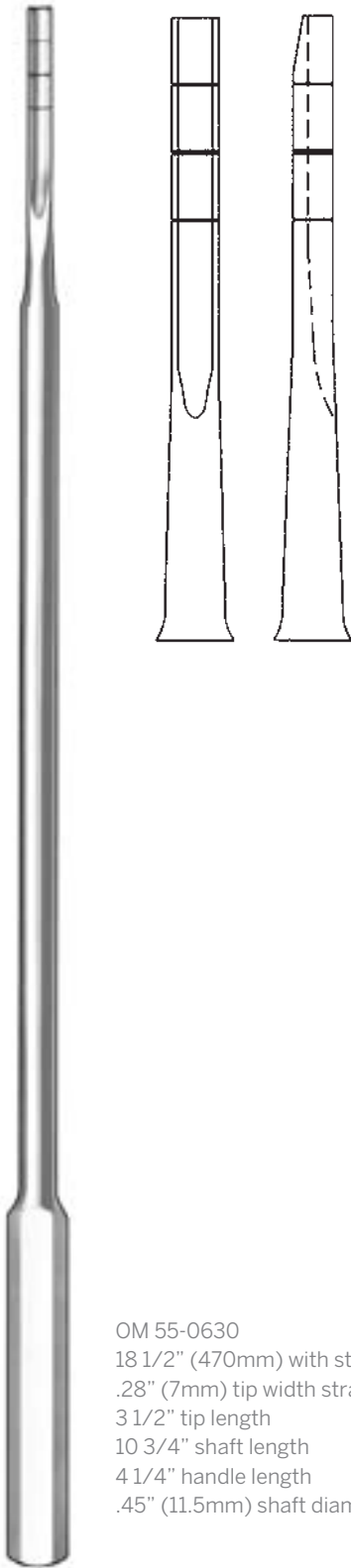

OM 55-0630
18 1/2" (470mm) with stainless steel handle
.28" (7mm) tip width straight
3 1/2" tip length
10 3/4" shaft length
4 1/4" handle length
.45" (11.5mm) shaft diameter

ENDOSCOPIC HIBBS GOUGE

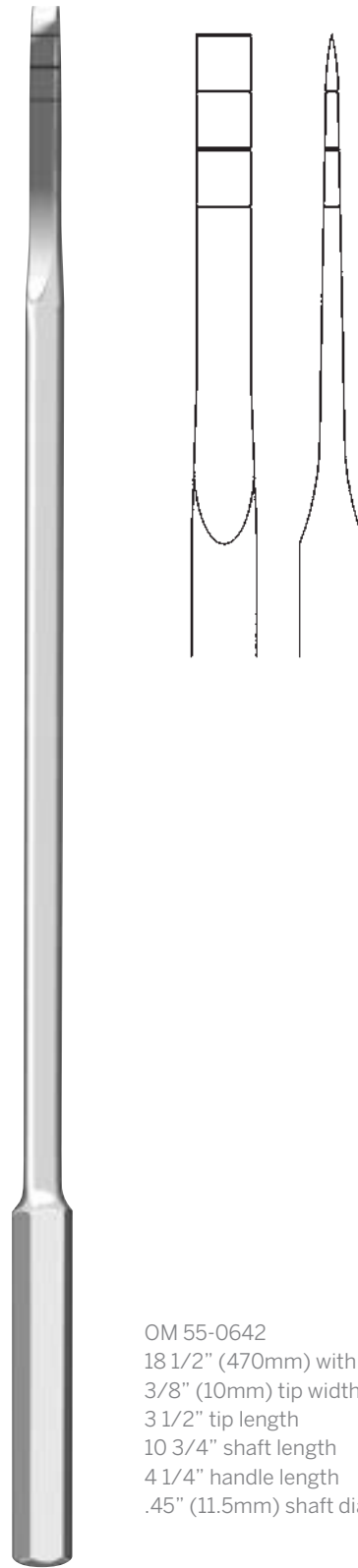

OM 55-0642
18 1/2" (470mm) with stainless steel handle
3/8" (10mm) tip width straight
3 1/2" tip length
10 3/4" shaft length
4 1/4" handle length
.45" (11.5mm) shaft diameter

ENDOSCOPIC HIBBS OSTEOTOME

MALLETS, TAMPS AND IMPACTORS



SECTION K



Mallets exert force on osteotomes, chisels and gouges.
Tamps wedge bone graft into place.

CONTENTS

Mallets	1-6
Tamps	7-8
Impactors and Drivers	8-10

ORTHO+MED
The Surgical Instrument Specialists

All instruments shown in this catalog are made of surgical grade stainless steel unless otherwise specified.

Note: Lead filled mallets should only be used to strike flat surfaces. Do not use to hit sharp objects as doing so can cause lead to flake off.



OM 49-0765
7" (178mm)
solid stainless steel
weight: 4 oz. (120 grams)
head weight: 3 oz. (80 grams)
head diameter: 20mm

MINI Mallet



OM 49-0761
7½" (191mm)
solid stainless steel
weight: 7 oz. (200 grams)
head weight: 3 oz. (80 grams)
head diameter: 19mm

OM 46-0660
8" (203mm)
brass head
stainless steel handle
weight: 9 oz. (260 grams)
head weight: 5 oz. (150 grams)
head diameter: 25mm

LUCAE BONE Mallet



OM 46-0656
7¾" (195mm)
lead filled and faced
weight: 7 oz. (200 grams)
head weight: 5 oz. (150 grams)
head diameter: 22mm

Mallet #49



OM 46-0661
7½" (191mm)
lead filled and faced
weight: 10 oz. (285 grams)
head weight: 7 oz. (200 grams)
head diameter: 25mm

GERZOG BONE Mallet

MALLETS

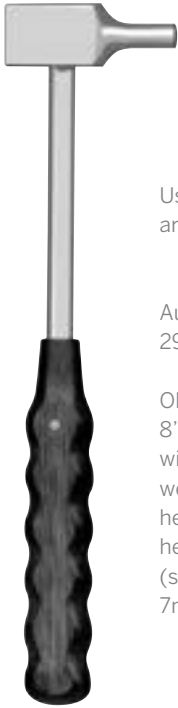

Useful for hand surgery and in areas where access is limited.

Autoclavable to 290° F (143° C).

OM 49-0764
8" (203mm)
with black plastic handle
weight: 7 oz. (200 grams)
head weight: 3 oz. (80 grams)
head diameter: 18mm x 18mm
(square contact surface)
7mm (round contact surface)

NARROW TIP Mallet



OM 49-0760
8" (203mm)
solid stainless steel
weight: 7 oz. (200 grams)
head weight: 5 oz. (150 grams)
head diameter: 30mm

LUCAE BONE Mallet



Autoclavable to 250° F (121° C).

OM 46-0662
7 ½" (191mm)
with two replaceable nylon caps
anodized aluminum handle
weight: 7 oz. (200 grams)
head weight: 4 oz. (120 grams)
head diameter: 25mm

Mallet with Nylon Caps

Lightweight



Autoclavable to 250° F (121° C).

OM 46-0657
7 ½" (191mm)
with replaceable nylon caps
weight: 11 oz. (315 grams)
head weight: 6 oz. (170 grams)
head diameter: 20mm

MEAD Mallet



Autoclavable to
250° F (121° C).

OM 46-0686
7½" (191mm)
weight: 9 oz. (260 grams)
head weight: 5 oz. (150 grams)
head diameter: 26mm

OM 46-0687
7½" (191mm)
weight: 12 oz. (340 grams)
head weight: 8 oz. (240 grams)
head diameter: 30mm

COMBINATION Mallet

With one nylon cap and one solid stainless side



OM 55-0400
7 ½" (191mm)
weight: 8 oz. (240 grams)
head weight: 4 oz. (120 grams)
head diameter: 19mm
ball pean diameter: 16mm

OM 55-0401
9" (229mm)
weight: 1 lb. (450 grams)
head weight: 8 oz. (240 grams)
head diameter: 25mm
ball pean diameter: 22mm

CLOWARD-STYLE Mallet

Solid stainless steel



OM 49-0763
7" (178mm)
solid stainless steel
weight: 1 lb. 2oz (500 grams)
head weight: 8oz (240 grams)
head diameter: 30mm

ORTHOPEDIC Mallet

Short handle, lightweight



Head is brass filled
and should only be
used to strike flat
surfaces.

OM 46-0658
7¾" (195mm)
weight: 1 lb. 7 oz. (650 grams)
head weight: 1 lb. 4 oz. (570 grams)
head diameter: 38mm

KIRK Mallet

MALLETS



OM 49-0762
7 ½" (191mm)
solid stainless steel
weight: 2 lbs. (900 grams)
head weight: 1 lb. 5 oz. (600 grams)
head diameter: 38mm

ORTHOPEDIC MALLET

Heavyweight, short handle



OM 49-0766
9" (229mm)
aluminum alloy handle
weight: 15 oz. (420 grams)
head weight: 9 oz. (260 grams)
head diameter: 30mm

BERGMAN MALLET



OM 49-0767
9 ½" (241mm)
aluminum alloy handle
weight: 1 lb. 1 oz. (470 grams)
head weight: 11 oz. (310 grams)
head diameter: 45mm

BERGMAN MALLET



OM 46-0663
7 ½" (191mm)
aluminum handle
weight: 2 lbs. (900 grams)
head weight: 1 lb. 4 oz. (570 grams)
head diameter: 40mm

HEATH MALLET

Heavyweight



Also known as dead blow mallet.

Grooved phenolic handle for comfortable grip.
Autoclavable to 250° F (121° C).

OM 46-0690
11 ½" (292mm)
weight: 1 lb. 5 oz. (600 grams)
head weight: 10 oz. (285 grams)
head diameter: 32mm
dead blow mallet with black plastic handle, one nylon cap and one stainless steel side

REPROCUSSION FREE MALLET



OM 46-0667
10 ½" (267mm)
solid stainless steel
weight: 3 lbs. (1360 grams)
head weight: 2 lbs. (900 grams)
head diameter: 48mm

ORTHOPEDIC MALLET

Heavyweight

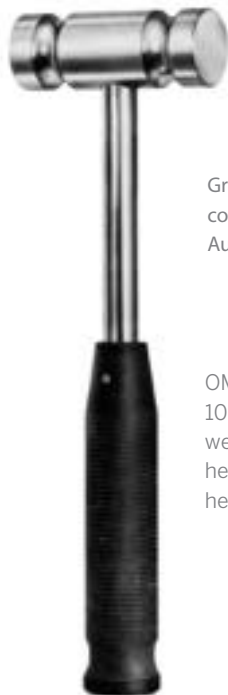

Grooved phenolic handle for comfortable and safe grip.
Autoclavable to 290° F (143° C).

OM 46-0688
10" (254mm)
weight: 1 lb. 11 oz. (765 grams)
head weight: 1 lb. (455 grams)
head diameter: 35mm

BLACK PLASTIC HANDLE MALLET



OM 46-0666
10 ¾" (273mm)
solid stainless steel
weight: 2 lbs. (900 grams)
head weight: 1 lb. (455 grams)
head diameter: 32mm

ORTHOPEDIC MALLET

Lightweight



Grooved phenolic handle for comfortable and safe grip. Autoclavable to 290° F (143° C).

OM 46-0689
11" (280mm)
weight: 2 lbs. 9 oz. (1160 grams)
head weight: 2 lbs. (900 grams)
head diameter: 45mm

BLACK PLASTIC Mallet



3 lb Mallet

OM 46-0697
10 1/2" (267mm) overall length
8 3/4" (222mm) knurled handle
37mm head diameter
70mm head length

5 lb Mallet

OM 46-0698
11" (280mm) overall length
8 3/4" (222mm) knurled handle
60mm head diameter
72.5mm head length



OM 49-0770
9 3/4" (248mm)

WAGNER Mallet



OM 49-0771
1 pair of metal disks



OM 49-0772
1 pair of plastic disks



OM 49-0773
wrench



FEMORAL HEAD DRIVER

OM ZIM 9027-58
 6 3/4" w/removable concave nylon cap
 head diameter: 38mm
 lightweight aluminum handle

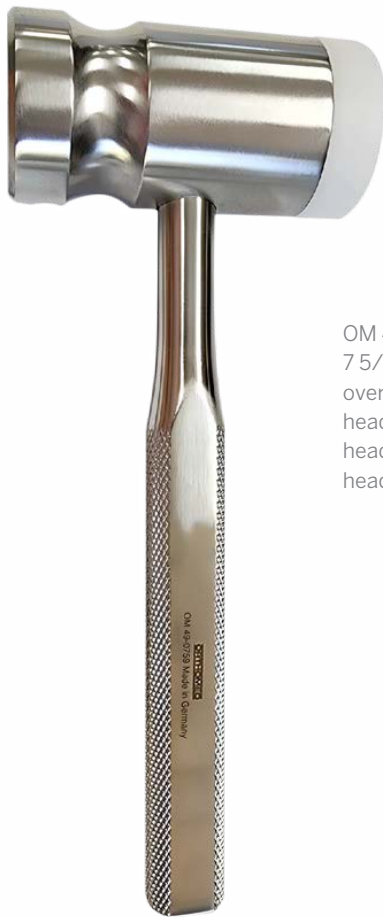

OM 49-0759
 7 5/8" overall length
 overall weight: 1.7 lbs
 head weight: 1.1 lbs
 head diameter: 38mm
 head length: 76mm

COMBINATION Mallet W/NYLON CAP



OM 12500
 9" (230mm) overall length
 weight: 1lb. 7oz (700 gr)
 head diameter: 40mm

BONE Mallet

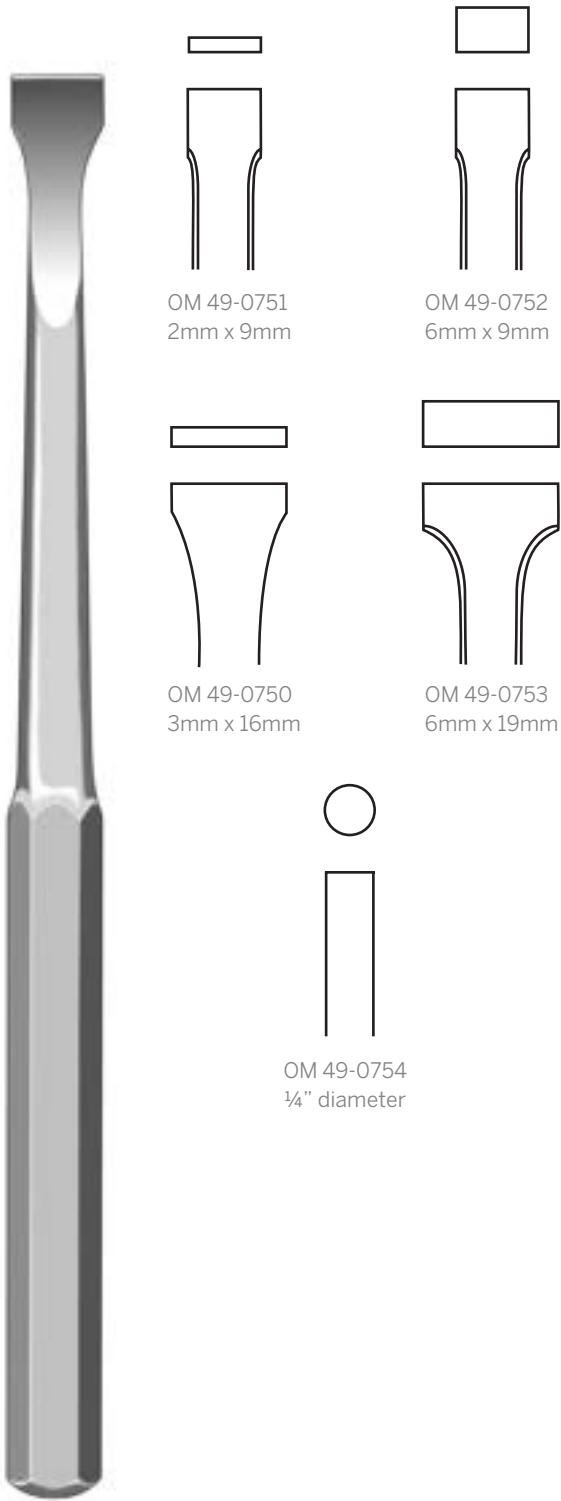

BONE CHIP PACKER
10" (254mm)

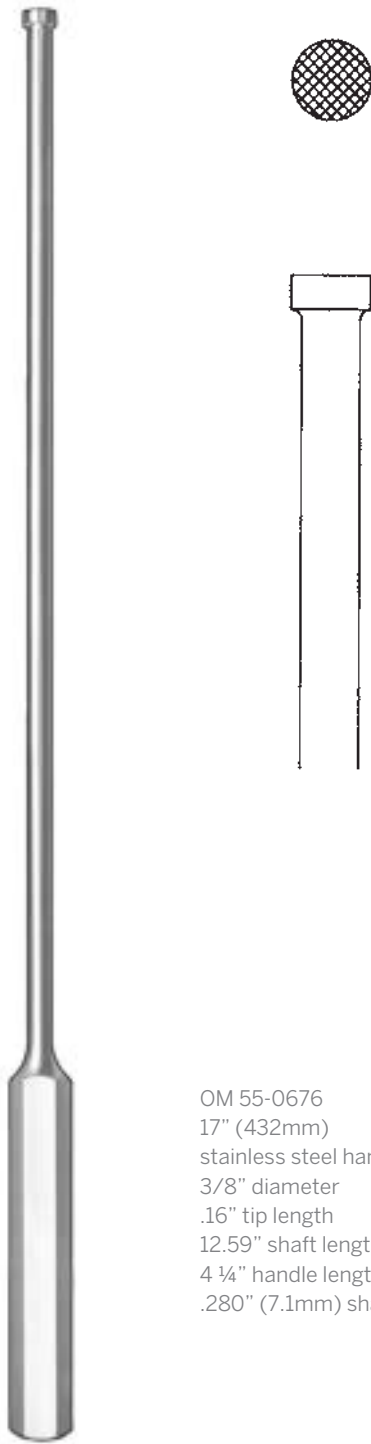

OM 55-0676
17" (432mm)
stainless steel handle
3/8" diameter
.16" tip length
12.59" shaft length
4 1/4" handle length
.280" (7.1mm) shaft diameter

BONE TAMP
Endoscopic

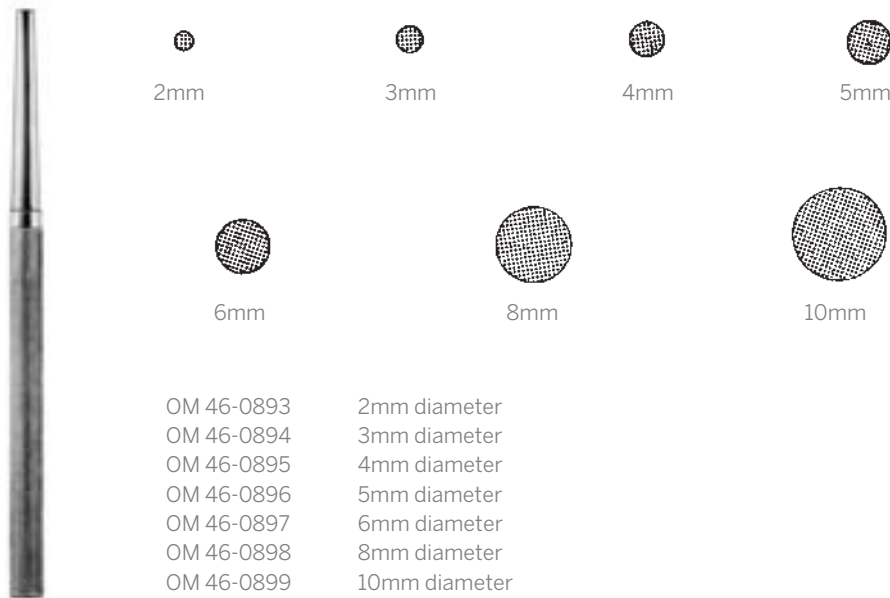

2mm 3mm 4mm 5mm

6mm 8mm 10mm

- OM 46-0893 2mm diameter
- OM 46-0894 3mm diameter
- OM 46-0895 4mm diameter
- OM 46-0896 5mm diameter
- OM 46-0897 6mm diameter
- OM 46-0898 8mm diameter
- OM 46-0899 10mm diameter

BONE TAMP

With cross serrated tip
6" (152mm)



OM 69-0980P
replaceable nylon cap

Designed to tap bone graft or bone parts into place with minimal trauma to the bone. The compactor head is nylon with a grid surface to prevent slippage.

Autoclavable to 250° (121°C).

OM 69-0980
6 ½" (165mm)
with replaceable nylon caps
anodized aluminum handle
head diameter: 20mm

BONE IMPACTOR



OM 55-0370
6mm x 12mm

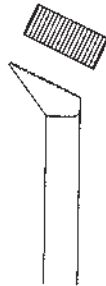

OM 55-0371
7mm x 16mm



OM 55-0372
6mm x 13mm



OM 55-0373
4mm x 10mm



OM 55-0374
4mm x 10mm



OM 55-0375
10mm x 13mm



OM 55-0376
7mm x 13mm



OM 55-0377
10mm x 13mm



OM 55-0378
7mm x 13mm

OM 55-0370	8 ½"	Impactor, standard offset
OM 55-0371	8 ½"	Impactor, central canal
OM 55-0372	8 ½"	Impactor, lateral narrow
OM 55-0373	7"	Impactor, micro offset
OM 55-0374	7"	Impactor, micro lateral
OM 55-0375	8 ½"	Graft Driver, lumbar, guarded
OM 55-0376	8 ½"	Graft Driver, anterior, guarded
OM 55-0377	8 ½"	Graft Driver, lumbar, unguarded
OM 55-0378	8 ½"	Graft Driver, anterior, unguarded

LUMBAR AND CERVICAL IMPACTORS AND DRIVERS

Serrated tips



OM 55-0384	Bone Graft Holder / Impactor 6" (152mm)	Serr 3.2mm 1/8"
OM 55-0385	Bone Graft Holder / Impactor 6" (152mm)	Serr 4.8mm 3/16"
OM 55-0386	Bone Graft Holder / Impactor 6" (152mm)	Serr 6.4mm 1/4"
OM 55-0387	Bone Graft Holder / Impactor 6" (152mm)	Serr 7.9mm 5/16"
OM 55-0388	Bone Graft Holder / Impactor 10" (254mm)	Serr 3.2mm 1/8"
OM 55-0389	Bone Graft Holder / Impactor 10" (254mm)	Serr 4.8mm 3/16"
OM 55-0390	Bone Graft Holder / Impactor 10" (254mm)	Serr 6.4mm 1/4"
OM 55-0391	Bone Graft Holder / Impactor 10" (254mm)	Serr 7.9mm 5/16"

BONE TAMP

With cross serrated tip
6" (152mm)

BONE HOLDING



SECTION L



To hold, stabilize, rotate, reduce and compress bone.

CONTENTS

Bone Holding Forceps	1-17
Bone Reduction Forceps	3-7
Pelvic Reduction Forceps	8-10
Bone Holding Clamps	11-13
Self-Retaining Forceps	18
Reduction Clamps	19-20
Repofix Forceps	21-22



OM 69-0787
6" (152mm)
1x2 teeth
serrated jaws

Very useful for removing the sesamoid bone.

LOCKE PHALANGEAL FORCEPS



OM 46-0804
7 1/2" (191mm)
angular
2x2 sharp teeth
serrated jaws

Delicate serrated jaws for holding small bone fragments.

DINGMAN CARTILAGE AND BONE CLAMP



OM 69-0795
6 1/2" (165mm)
slightly curved

SESAMOIDECTOMY CLAMP



OM 47-0139
4 3/4" (121mm)
one pointed tip
and foot plate

 For positioning mini bone plates.

PLATE AND BONE HOLDING FORCEPS



Allows for placement of the bone clamp where it can best stabilize the bone fragments. The drill guide allows for screw placement through the opening at the top of the clamp.

- curved
- OM 90-1890-01
Small with 8mm drill guide with ratchet
- OM 90-1890-02
Large with 10mm drill guide with ratchet
- OM 90-1890-XSM
Extra small with 6mm drill guide with ratchet

O'BRIEN BONE CLAMP

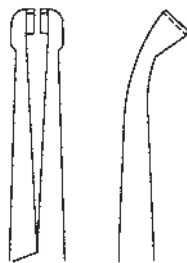
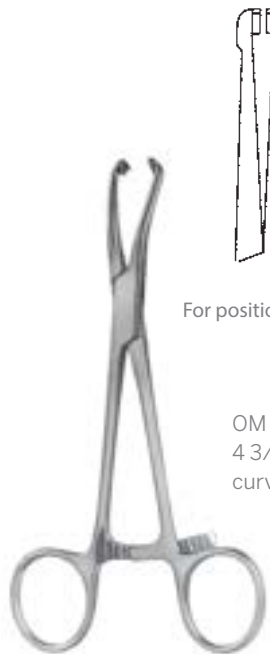

For positioning small bone plates.

OM 47-0138
4 3/4" (121mm)
curved

PLATE AND BONE HOLDING FORCEPS

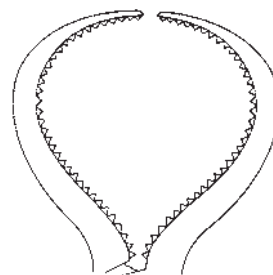

OM 47-0130
7" (178mm) serrated
slightly curved

OM 47-0131
7" (178mm) serrated
with long ratchet
slightly curved

LEWIN BONE FORCEPS



OM 47-0012
7" (178mm)
with speed lock
2x2 sharp teeth

PATELLA FORCEPS



OM 47-0170
8 1/2" (216mm)
with speed lock
angular tip

FIBULA FORCEPS



Grasping forceps
for small bones.

OM 47-0010
8 1/4" (210mm)
1x1 sharp points

MALLEOLLAR FORCEPS

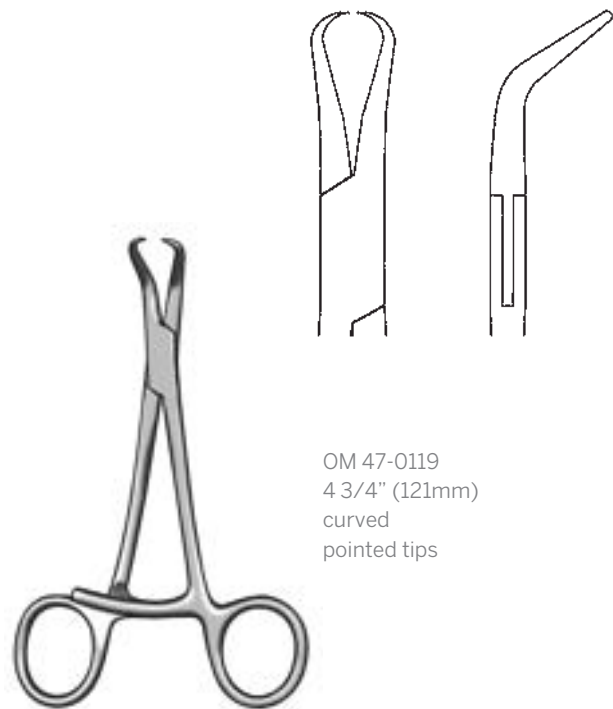

OM 47-0119
4 3/4" (121mm)
curved
pointed tips

**STAGBEETLE BONE
REDUCTION FORCEPS**

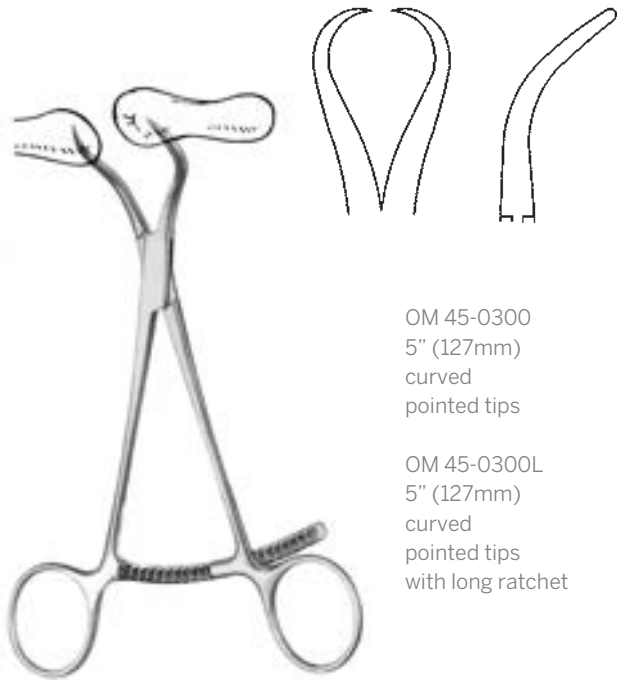

OM 45-0300
5" (127mm)
curved
pointed tips

OM 45-0300L
5" (127mm)
curved
pointed tips
with long ratchet

BONE REDUCTION FORCEPS

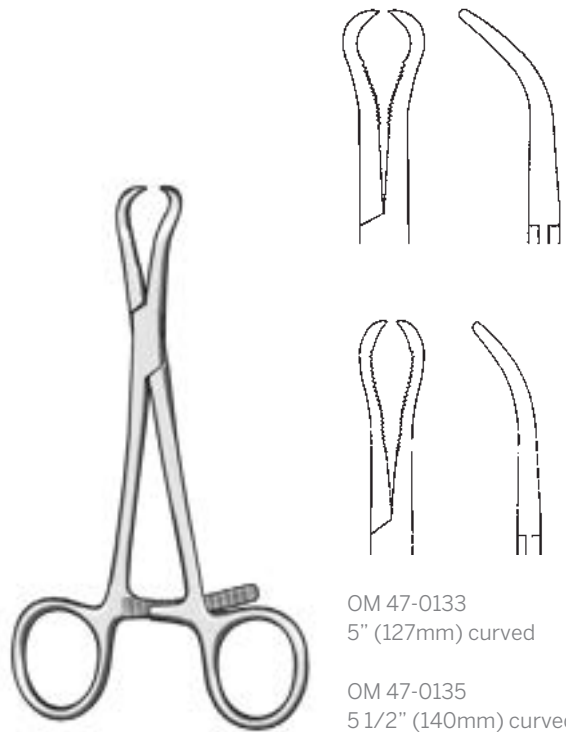

OM 47-0133
5" (127mm) curved

OM 47-0135
5 1/2" (140mm) curved

BONE REDUCTION FORCEPS

Serrated with pointed tips

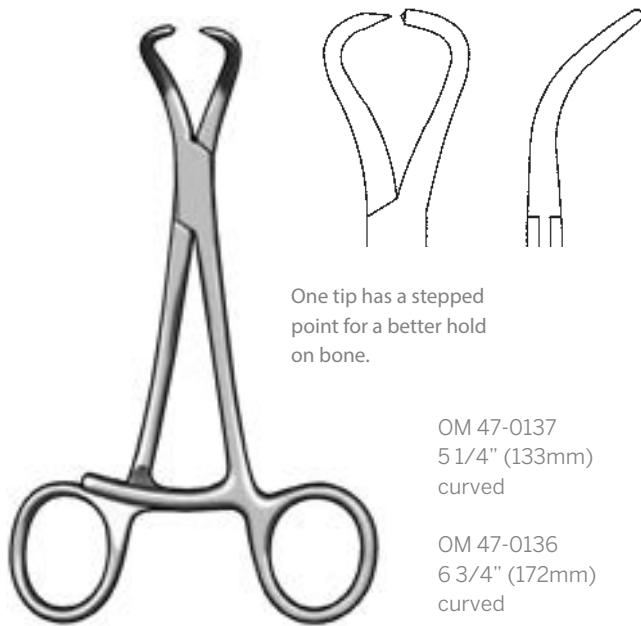

One tip has a stepped point for a better hold on bone.

OM 47-0137
5 1/4" (133mm)
curved

OM 47-0136
6 3/4" (172mm)
curved

BONE REDUCTION FORCEPS

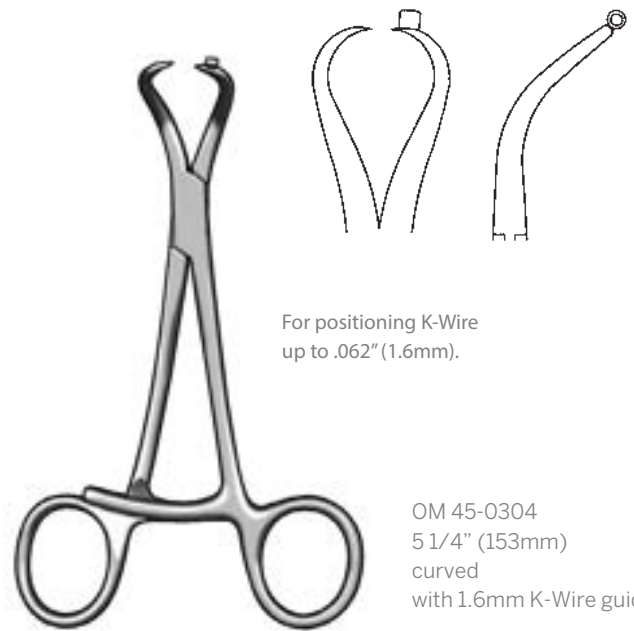

For positioning K-Wire up to .062" (1.6mm).

OM 45-0304
5 1/4" (153mm)
curved
with 1.6mm K-Wire guide

BONE HOLDING FORCEPS

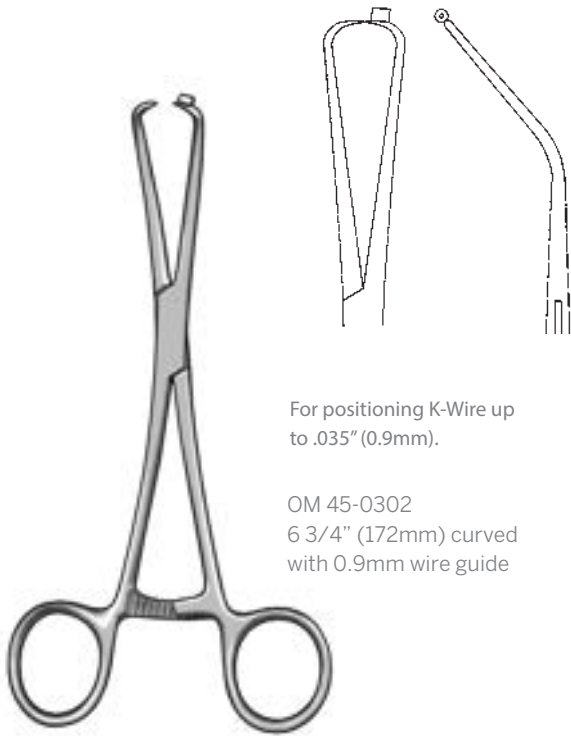

For positioning K-Wire up to .035" (0.9mm).

OM 45-0302
6 3/4" (172mm) curved with 0.9mm wire guide

BONE HOLDING FORCEPS

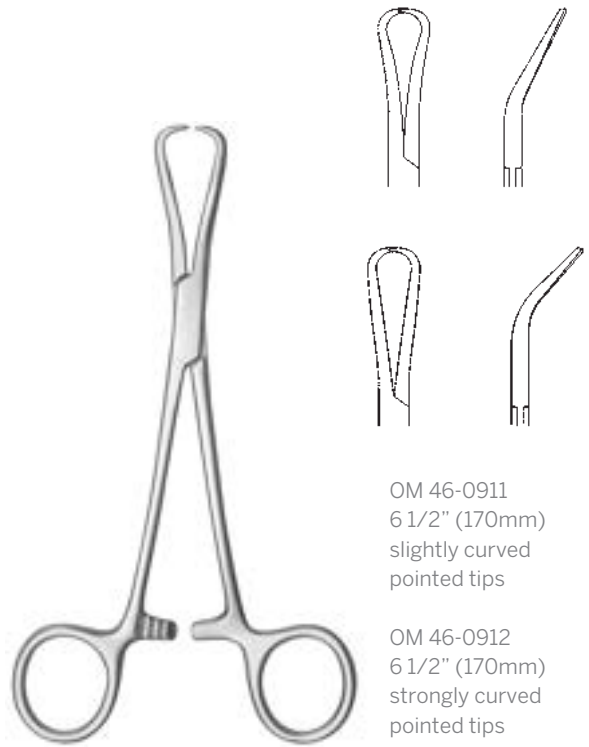

OM 46-0911
6 1/2" (170mm) slightly curved pointed tips

OM 46-0912
6 1/2" (170mm) strongly curved pointed tips

GLENOID PERFORATING FORCEPS

OM 47-0129
6" (152mm) angular
inside fenestration: 22mm x 14mm
outside fenestration: 30mm x 20mm
ratchet length: 3"

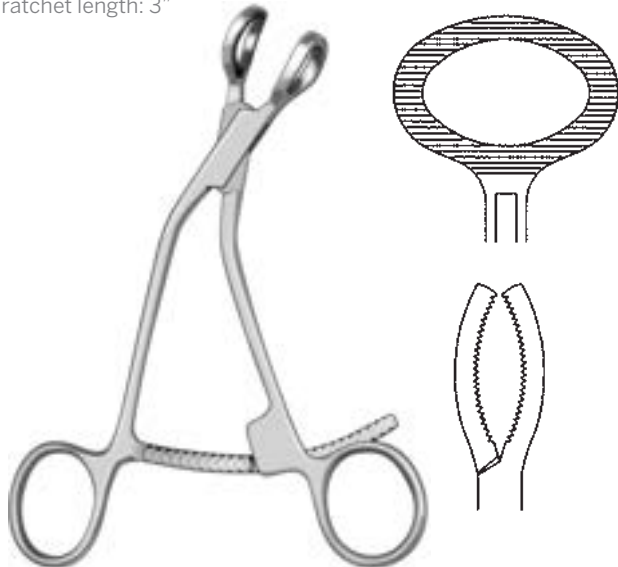

BONE HOLDING FORCEPS
with fenestration



OM 47-0132
7" (178mm) curved pointed tips

REILL BONE REDUCTION FORCEPS



BONE REDUCTION FORCEPS

OM 47-0127 5 1/2" (140mm) curved narrow tip



OM 45-0305 5" (127mm) .035" (0.9mm) curved
 OM 45-0306 5" (127mm) .045" (1.1mm) curved
 OM 45-0307 5" (127mm) .062" (1.6mm) curved

BONE HOLDING FORCEPS

With K-Wire guide

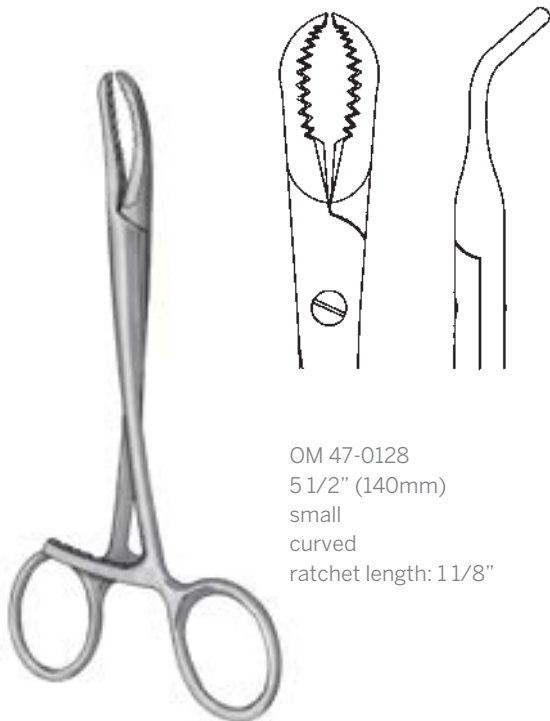

OM 47-0128
 5 1/2" (140mm)
 small
 curved
 ratchet length: 1 1/8"

BONE REDUCTION FORCEPS

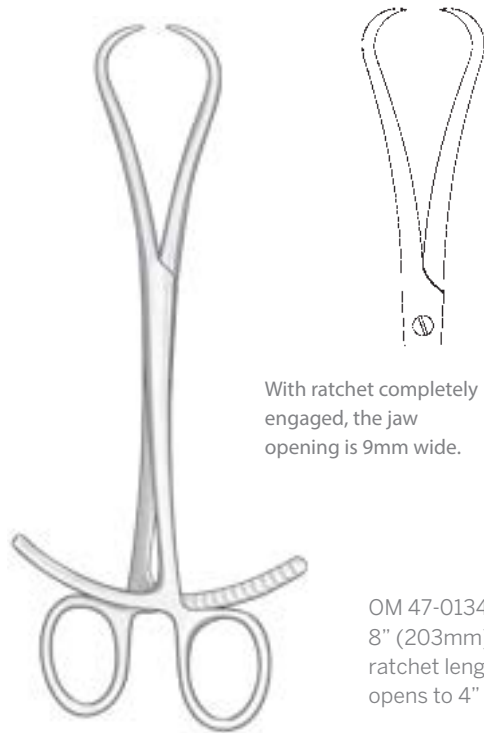

With ratchet completely engaged, the jaw opening is 9mm wide.

OM 47-0134
 8" (203mm)
 ratchet length: 2"
 opens to 4"

BONE REDUCTION FORCEPS



OM 45-0326
10 1/4" (260mm)

REPOSITION FORCEPS



OM 90-1830
Small, 5 1/2" (140mm) with speed lock

OM 90-1835
Medium, 6" (152mm) with speed lock

OM 90-1840
Large, 8" (203mm) with speed lock

BONE FRAGMENT CLAMP



OM 47-0135L
5 1/2" (140mm) curved
serrated with pointed tips extra
long ratchet

BONE REDUCTION FORCEPS

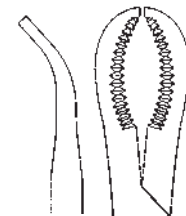

OM 47-0105 7" (178mm) curved
OM 47-0107 9" (229mm) curved

BONE REDUCTION FORCEPS

With speed lock



OM 47-0074
7 1/2" (191mm)
curved sideways
deep teeth
without ratchet



OM 47-0076
8" (203mm)
curved sideways
deep teeth
with ratchet

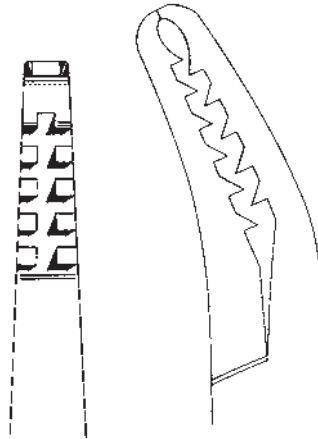

SEMB BONE HOLDING FORCEPS

With or without ratchet



OM 47-0072
9" (229mm)
curved sideways
serrated

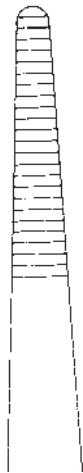

VAN BUREN SEQUESTRUM FORCEPS



OM 47-0198
8 1/4" (210mm)
deep teeth

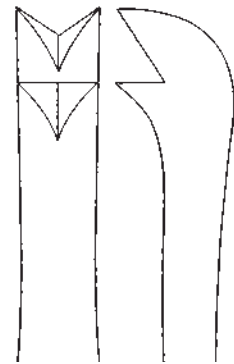

FERGUSSON BONE HOLDING FORCEPS



OM 47-0200
8 1/4" (210mm)
2x2 teeth

LANGENBECK BONE HOLDING FORCEPS

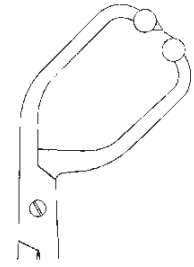
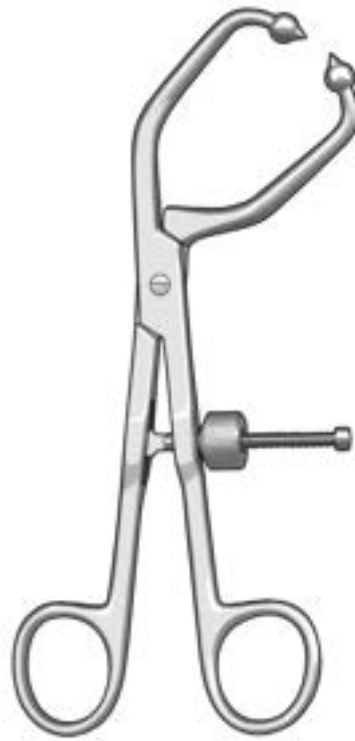

OM 45-0312
7 3/8" (187mm)
angular
short pointed-ball tip

PELVIC REDUCTION FORCEPS

Short tips

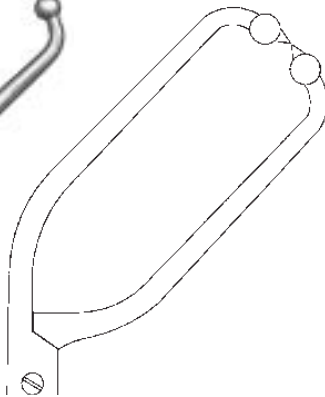
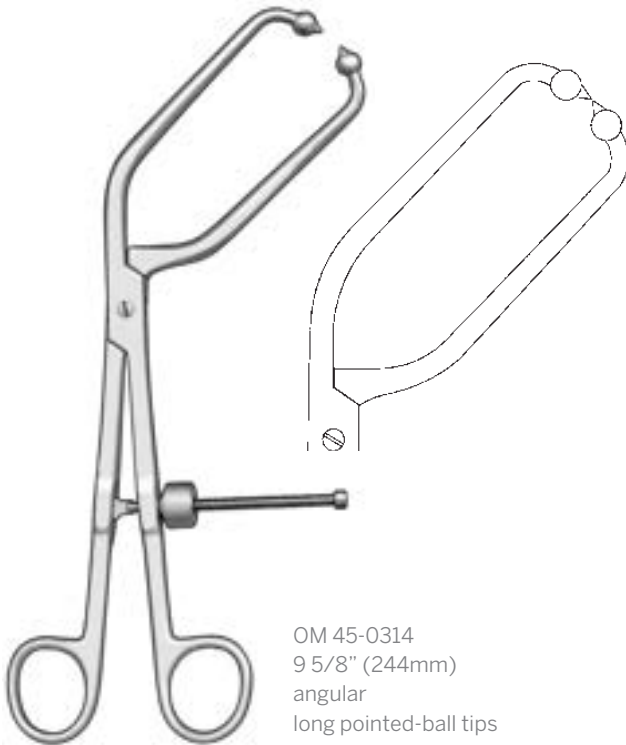

OM 45-0314
9 5/8" (244mm)
angular
long pointed-ball tips

PELVIC REDUCTION FORCEPS

Long tips

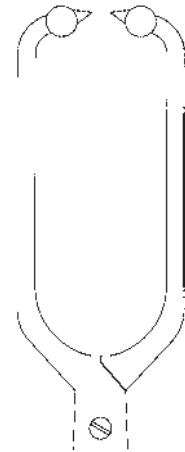

OM 47-0102
9 7/8" (251mm)
short pointed-ball tips

PELVIC REDUCTION FORCEPS

Angled tips

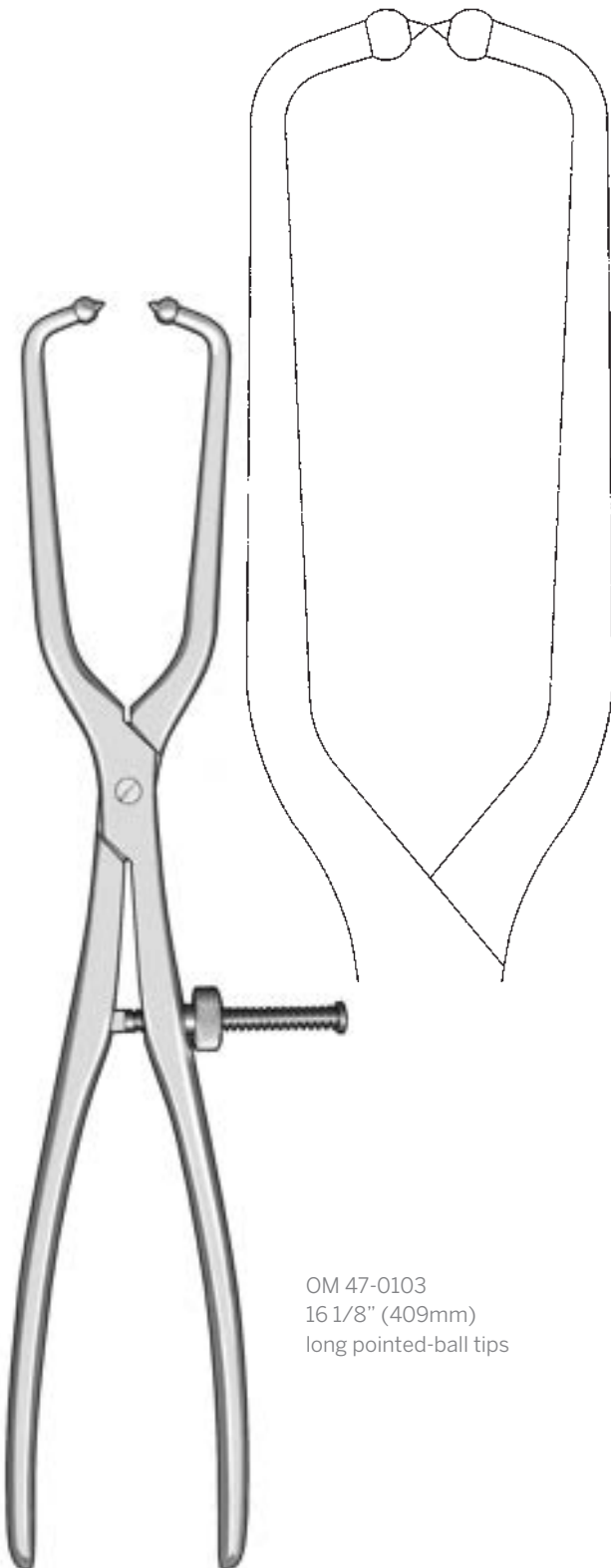

OM 47-0103
16 1/8" (409mm)
long pointed-ball tips

PELVIC REDUCTION FORCEPS

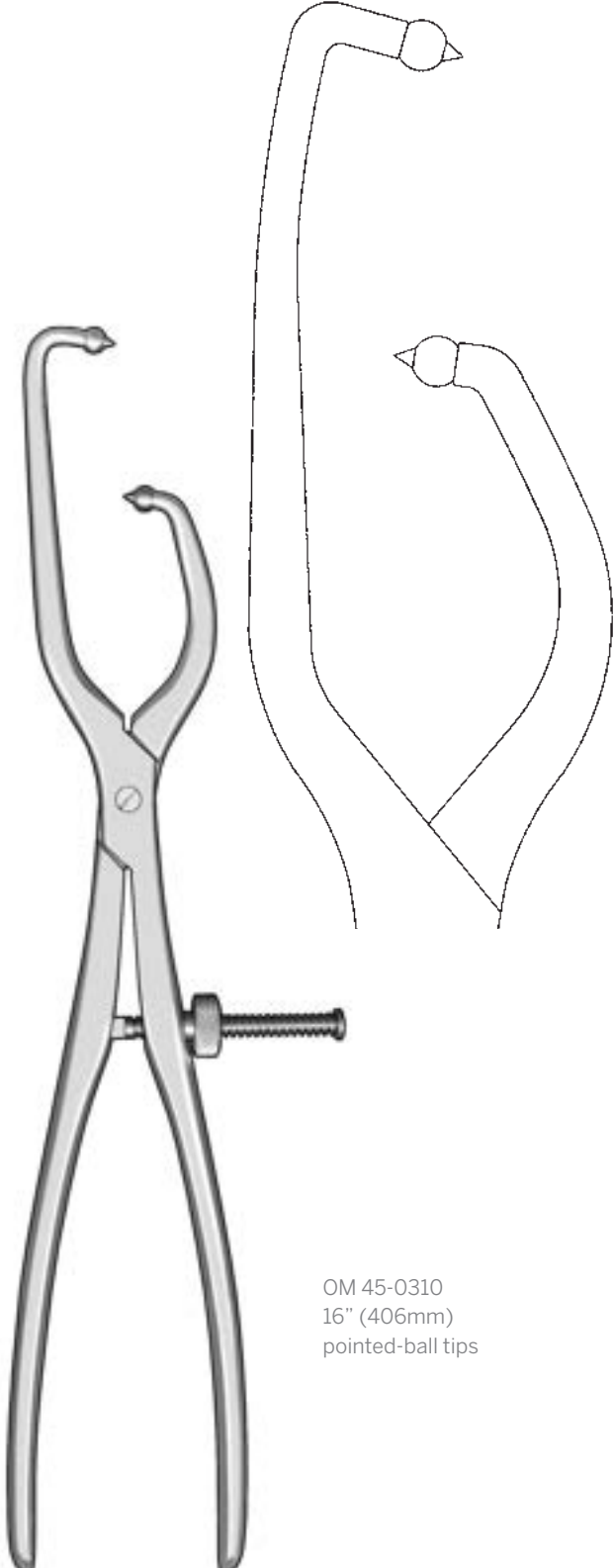

OM 45-0310
16" (406mm)
pointed-ball tips

ASYMMETRIC PELVIC REDUCTION FORCEPS

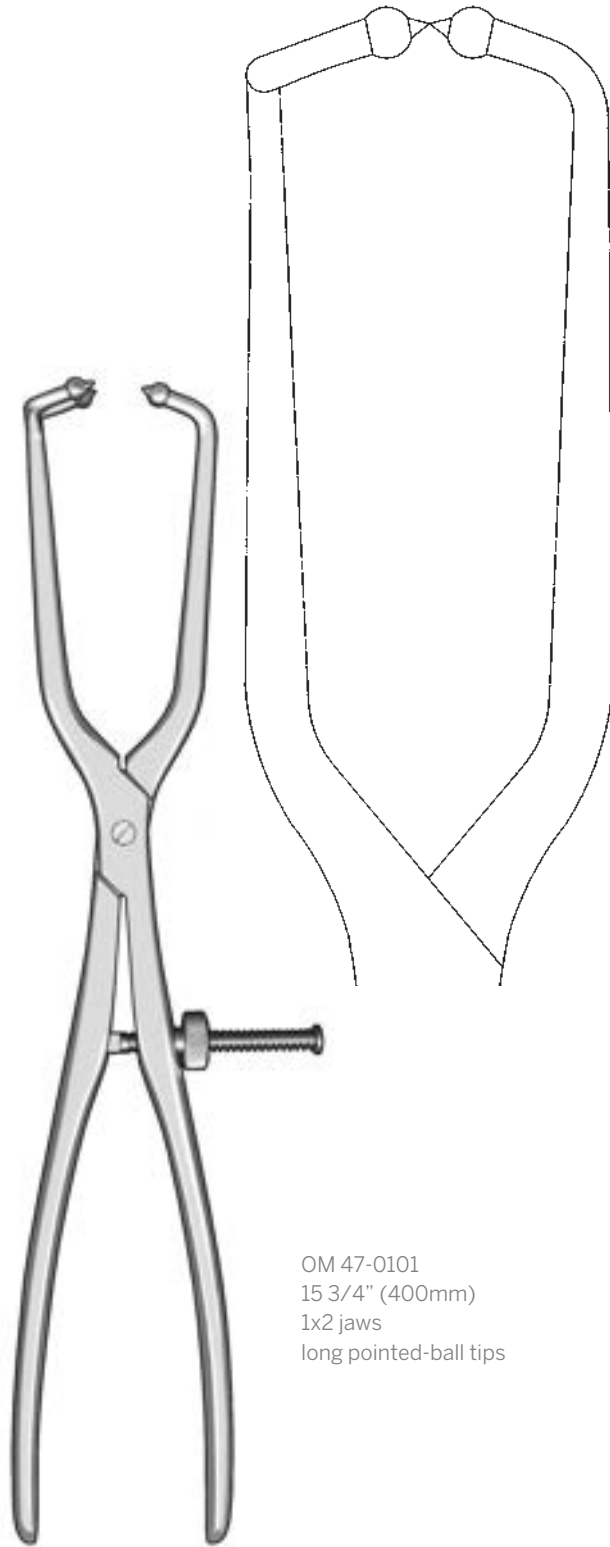

OM 47-0101
15 3/4" (400mm)
1x2 jaws
long pointed-ball tips

PELVIC REDUCTION FORCEPS

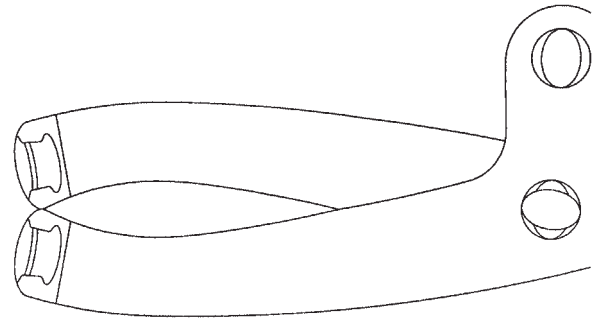

OM 47-0100
13 1/2" (343mm)
with screws

PELVIC REDUCTION FORCEPS

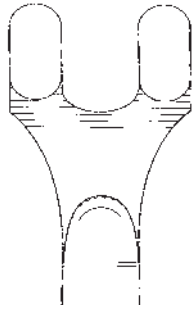

OM 47-0140
4 3/4" (121mm)

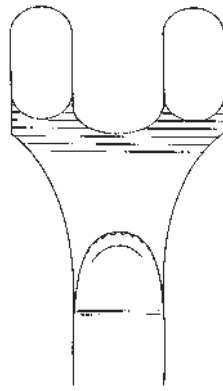

OM 47-0154
7 1/4" (184mm)

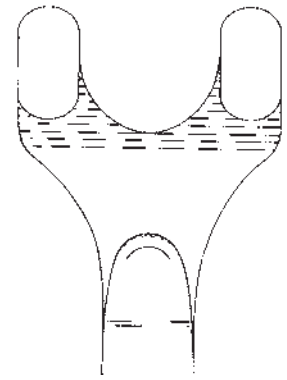

OM 47-0156
8" (203mm)

Calibrated in inches to
measure bone diameter.

LOWMAN BONE CLAMP

1x2 jaws

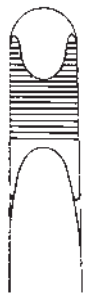

OM 47-0160
4 3/4" (121mm)



OM 47-0164
7 1/4" (184mm)



OM 47-0166
8" (203mm)

Calibrated in inches to
measure bone diameter.

LOWMAN BONE CLAMP

1x1 jaws

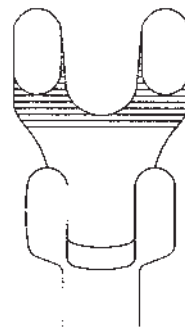
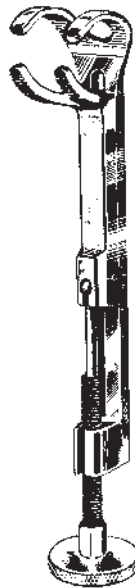

OM 47-0167
7 1/4" (184mm)

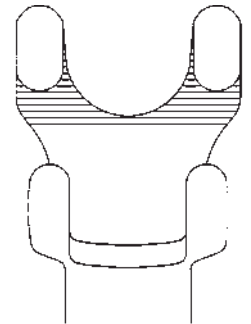

OM 47-0168
8" (203mm)

Calibrated in inches to
measure bone diameter.

LAMBERT-LOWMAN BONE CLAMP

2x2 jaws



OM 47-0054
5 3/4" (146mm)
mini

OM 47-0056
8 1/2" (216mm)

KERN BONE FORCEPS
Without ratchet

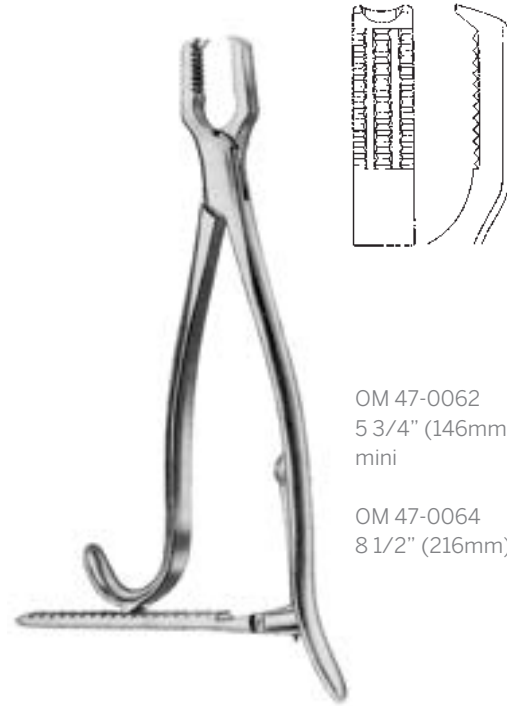

OM 47-0062
5 3/4" (146mm)
mini

OM 47-0064
8 1/2" (216mm)

KERN BONE FORCEPS
With ratchet

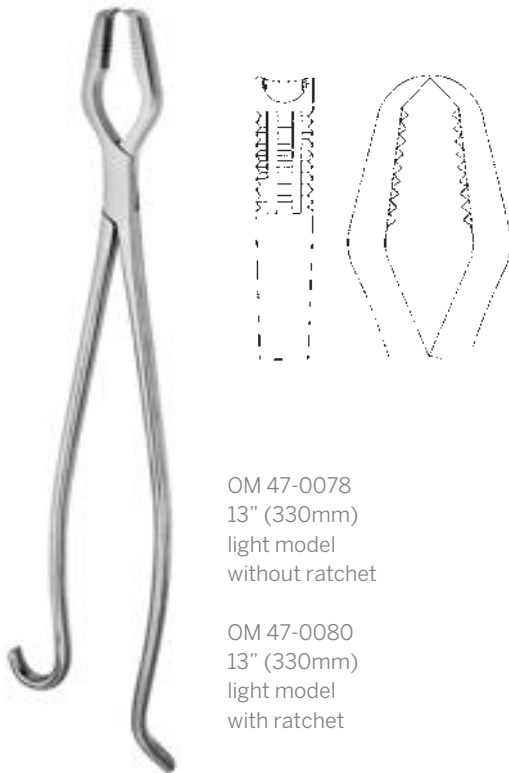

OM 47-0078
13" (330mm)
light model
without ratchet

OM 47-0080
13" (330mm)
light model
with ratchet

LANE BONE HOLDING FORCEPS
Without ratchet

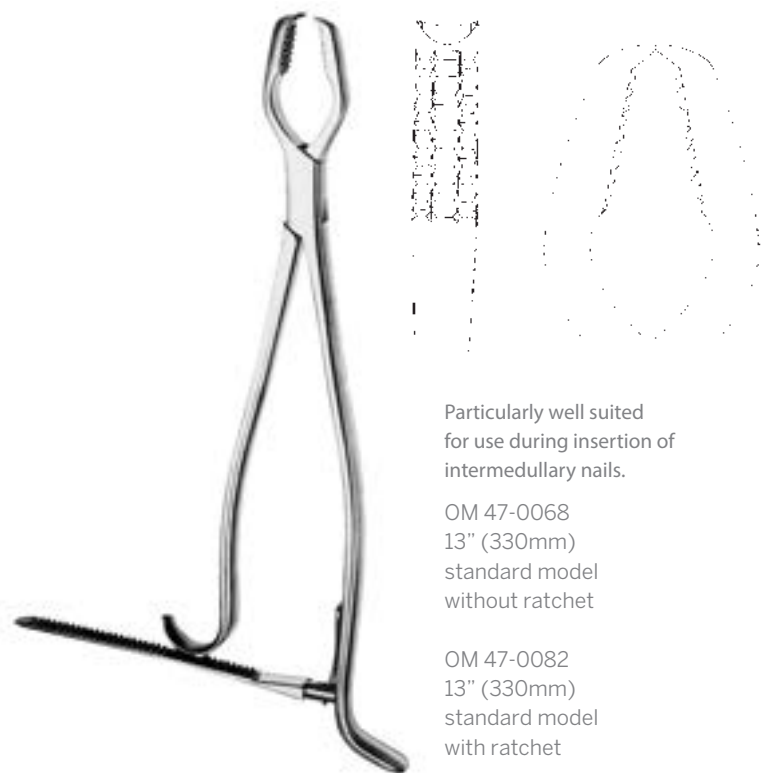

Particularly well suited
for use during insertion of
intermedullary nails.

OM 47-0068
13" (330mm)
standard model
without ratchet

OM 47-0082
13" (330mm)
standard model
with ratchet

LANE BONE HOLDING FORCEPS
With ratchet

BONE HOLDING INSTRUMENTS

OM 47-0070
17" (432mm)
without ratchet



LANE BONE FORCEPS
Without ratchet

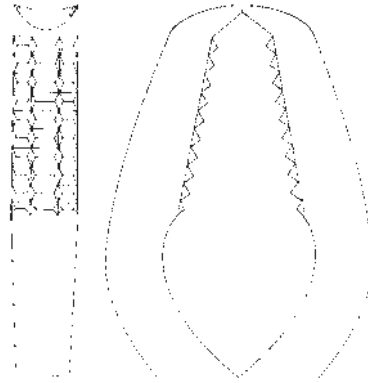

OM 47-0084
17" (432mm)
with ratchet



LANE BONE FORCEPS
With ratchet



Fit thin end of band through slot
in other end of band. Insert thin
end into clamp.

OM 47-0172
8 1/2" (216mm)
bands not included

OM 47-0173
single band only

PARHAM-MARTIN BONE CLAMP



OM 47-0090
6" (152mm)

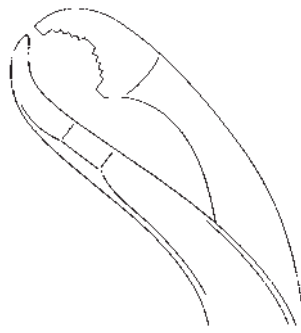

OM 47-0092
7 1/2" (191mm)

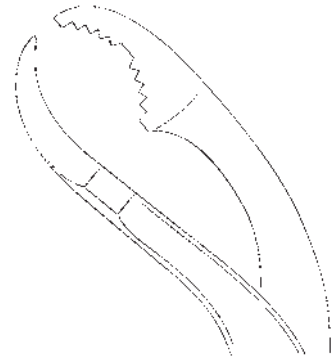

OM 47-0094
9 1/2" (241mm)

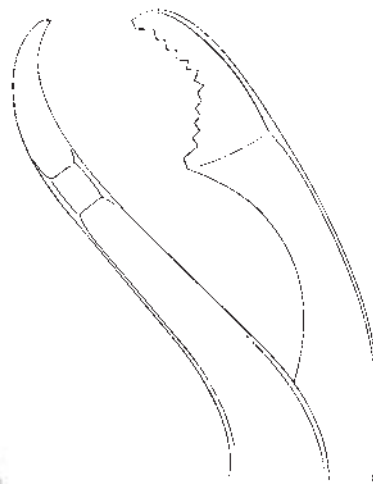

OM 47-0096
10 1/4" (260mm)

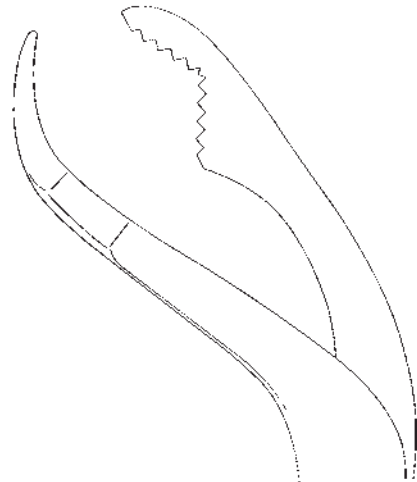

OM 47-0098
11" (280mm)

VERBRUGGE BONE HOLDING FORCEPS

Self centering, with speed lock

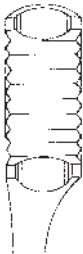
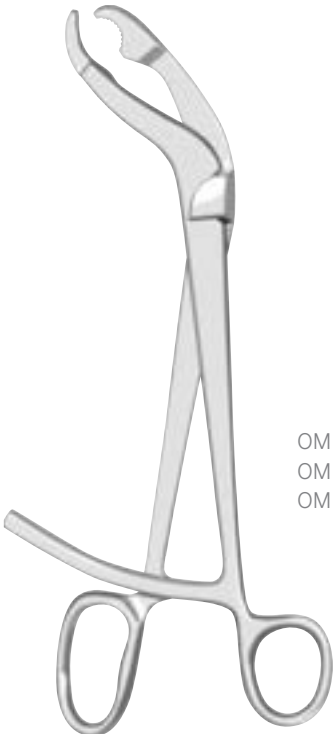

OM 47-0122 10" (254mm)
OM 47-0124 10 1/2" (267mm)
OM 47-0126 11" (280mm)

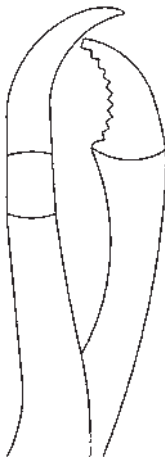

OM 47-0122

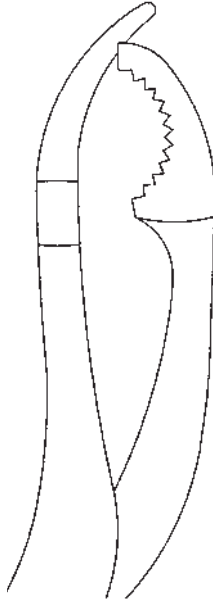

OM 47-0126

VERBRUGGE BONE HOLDING FORCEPS

With long ratchet

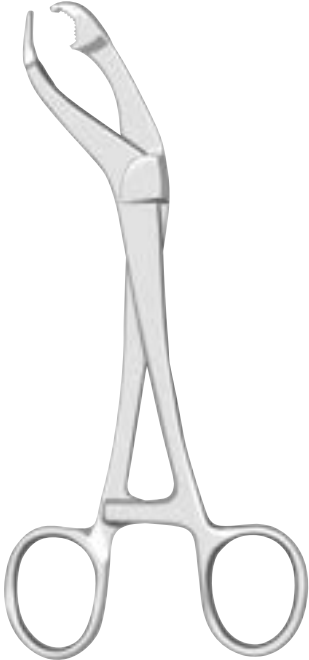

OM 47-0120
6 3/4" (172mm)

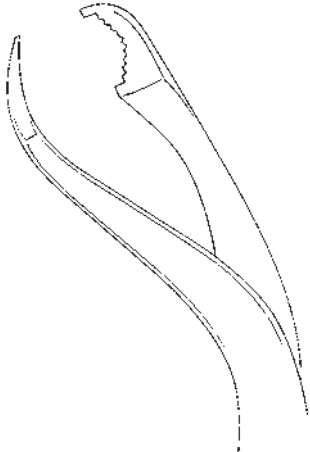

VERBRUGGE BONE HOLDING FORCEPS

With short ratchet

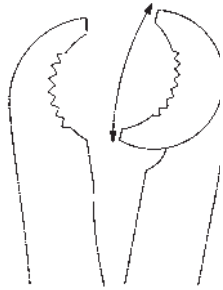

OM 47-0204

- OM 47-0204 8 1/2" (216mm)
- OM 47-0206 10 1/2" (267mm)
- OM 47-0208 11 1/2" (292mm)



LAMBOTTE BONE HOLDING FORCEPS

With swivel head, adjustable jaw

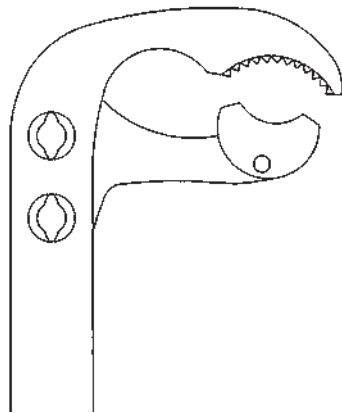

- OM 47-0212
8 1/2" (216mm)
with swivel head, adjustable jaw



BONE HOLDING FORCEPS

Angled

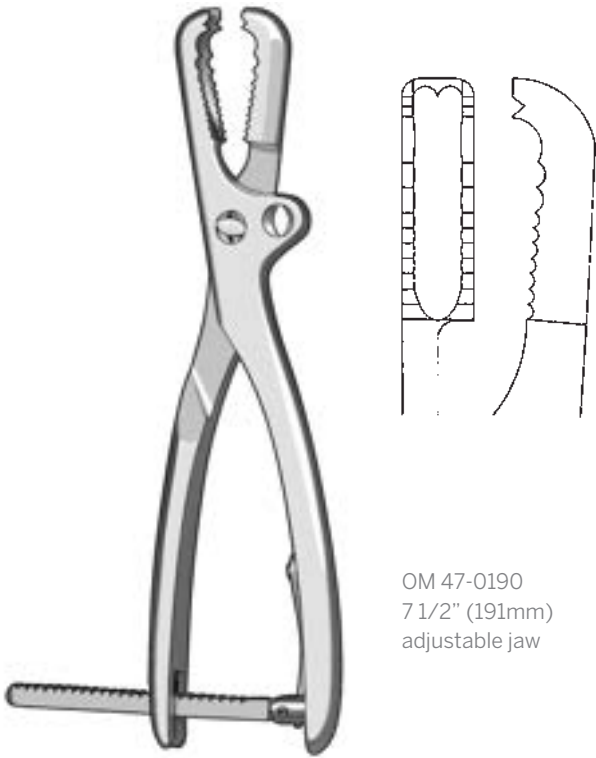

OM 47-0190
7 1/2" (191mm)
adjustable jaw

FARABEU-F-LAMBOTTE BONE HOLDING FORCEPS



OM 47-0192
10 1/2" (267mm)
adjustable jaw

FARABEU-F-LAMBOTTE BONE HOLDING FORCEPS



OM 47-0194 9" (229mm)
OM 47-0196 10" (254mm)

FARABEU BONE HOLDING FORCEPS
Adjustable jaw

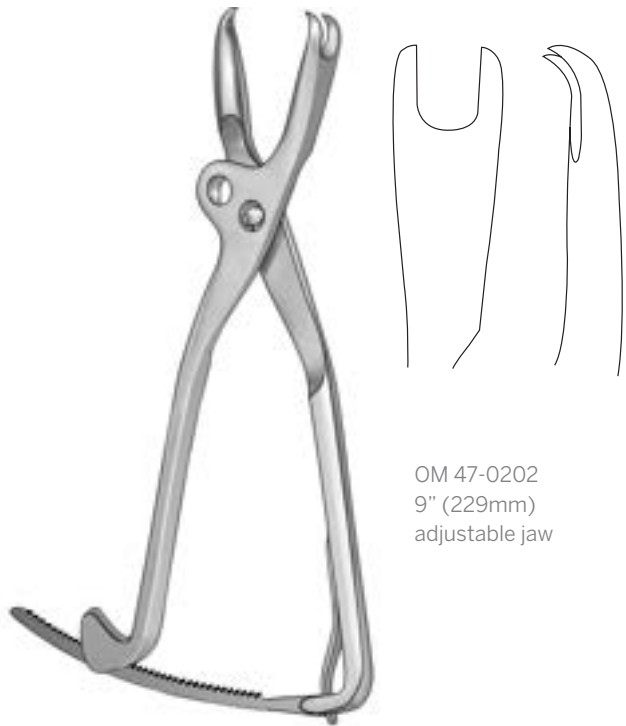

OM 47-0202
9" (229mm)
adjustable jaw

BISHOP BONE HOLDING FORCEPS



OM 47-0108
7 1/4" (184mm)
mini

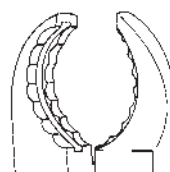

OM 47-0110
9" (229mm)

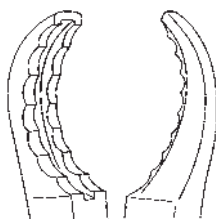

OM 47-0112
10" (254mm)

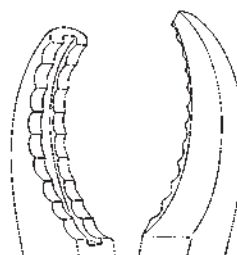

OM 47-0114
11" (280mm)

ULRICH SELF-RETAINING FORCEPS

Straight, with speed lock



OM 47-0109
7 1/4" (184mm)

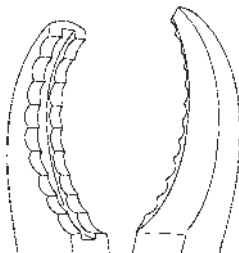

OM 47-0116
11" (280mm)

ULRICH SELF-RETAINING FORCEPS

Angular, with speed lock



OM 47-0118
11" (280mm)
angular
with speed lock
swivel jaw

ULRICH SELF-RETAINING FORCEPS



OM 47-0089
12" (305mm)
X-large opening 30-100mm

PERIARTICULAR REDUCTION CLAMP



OM 45-0366 Medium 15" w/speedlock opening 14mm to 190mm
OM 45-0370 Large 15" w/speedlock opening 32mm to 210mm

PERIARTICULAR REDUCTION CLAMP



OM 47-0088



OM 47-0086

OM 47-0086	5 1/4"	(133mm)	small
OM 47-0087	6 1/2"	(165mm)	medium
OM 47-0088	9"	(229mm)	large

**PERIARTICULAR
REDUCTION CLAMP**



OM 47-0025	6 1/4"	(159mm)	straight
OM 47-0030	6 1/4"	(159mm)	curved

IKUTA BONE CLAMP



OM 47-0115
5 3/4" CVD (146mm)

BONE REDUCTION FORCEPS

BONE HOLDING INSTRUMENTS



Drill



Measure



Insert screw

Forceps (only)

OM 91-0100

5" (127mm)

3.5mm Inner diameter of tube, for guides and implants (screws/wires)

40mm Maximum measurable bone width

Available Drill/Wire Guides

OM 91-0208 .8mm drill/wire opening

OM 91-0209 .9mm drill/wire opening

OM 91-0210 1.0mm drill/wire opening

OM 91-0211 1.1mm drill/wire opening

OM 91-0212 1.2mm drill/wire opening

OM 91-0213 1.3mm drill/wire opening

OM 91-0215 1.5mm drill/wire opening

OM 91-0220 2.0mm drill/wire opening



Sterilization Tray

OM 91-0010 Large enough to contain Repofix® Plus and Repofix® Spider

Repofix complete set with all guides and sterilization tray

OM 91-0000-Set

REPOFIX® PLUS

Maintains reduction as you drill, measure, & insert screws or wires through forceps tube.



- Fine tips allow reduction in limited spaces
- Speed lock tightening wheel for controlled reduction
- Measuring scale



OM 91-0120
5 3/8" (137mm)
50mm Maximum measurable bone width

Sterilization Tray
OM 91-0010 Large enough to contain Repofix® Plus and Repofix® Spider

REPOFIX® SPIDER

BONE CUTTING



SECTION M



To excise, trim and sculpt bone.

CONTENTS

Forceps	1-5
Saws	5-6
Amputation Shield and Knife	6-7
Saw Blades and Handles	7
Plug Cutter	8
Trephine	8
Bone Mills	9

Note: Replacement springs are available. To order, refer to the corresponding product number.

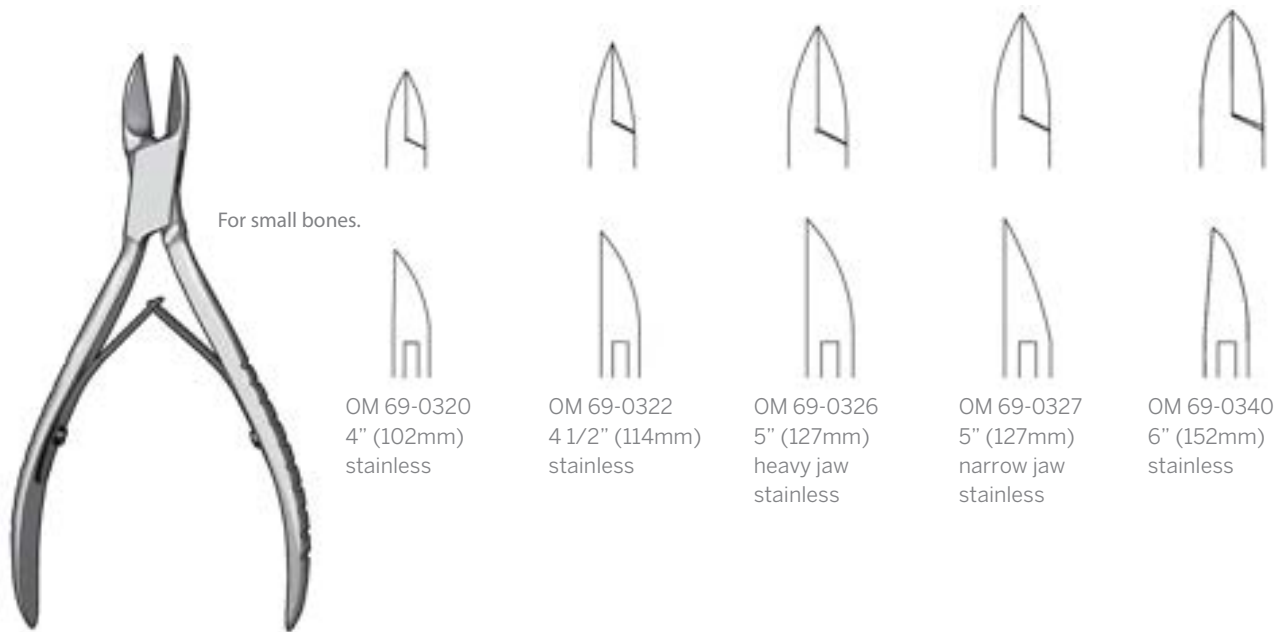

LITTAUER BONE FORCEPS

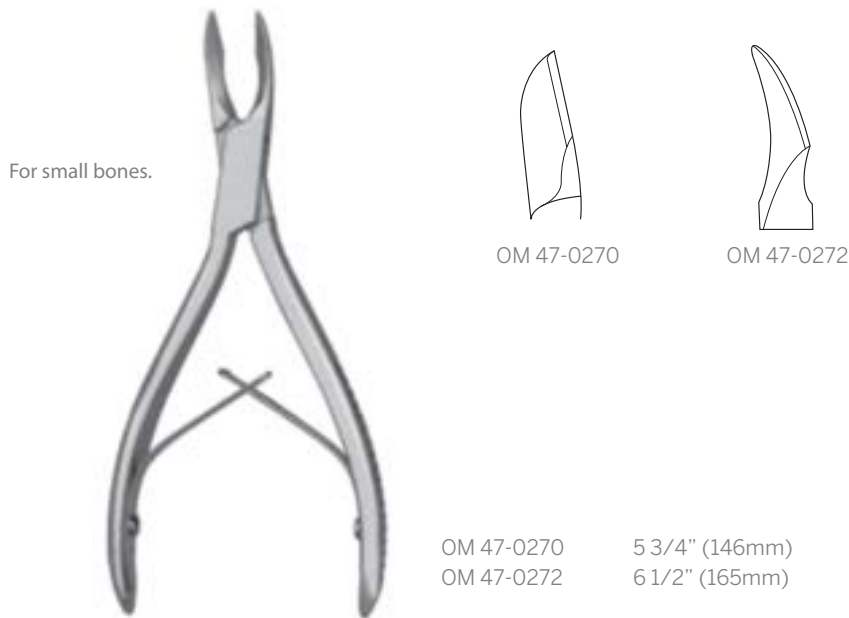

BONE CUTTING FORCEPS (CLEVELAND)

BONE CUTTING FORCEPS

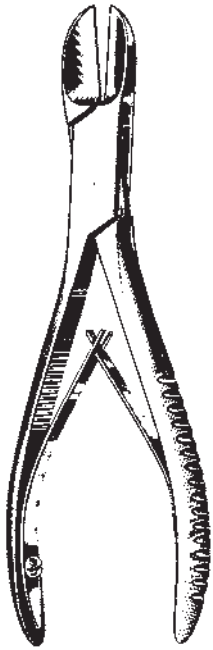

LISTON BONE FORCEPS

For small bones.



OM 47-0398
5 1/2" straight



OM 47-0410
5 1/2" angled
on flat



OM 47-0400
6 3/4" straight



OM 47-0404
6 3/4" angled
on flat



OM 47-0402
7 1/2" straight

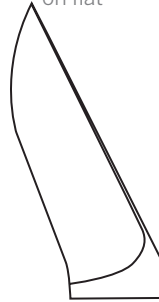

OM 47-0412
7 1/2" angled
on flat



OM 47-0406
8 1/2" straight

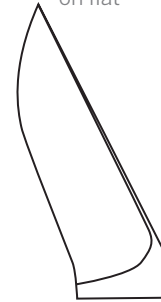

OM 47-0408
8 1/2" angled
on flat

Straight

OM 47-0398	5 1/2" (140mm)
OM 47-0400	6 3/4" (171mm)
OM 47-0402	7 1/2" (191mm)
OM 47-0406	8 1/2" (216mm)

Angled on flat

OM 47-0410	5 1/2" (140mm)
OM 47-0404	6 3/4" (171mm)
OM 47-0412	7 1/2" (191mm)
OM 47-0408	8 1/2" (216mm)

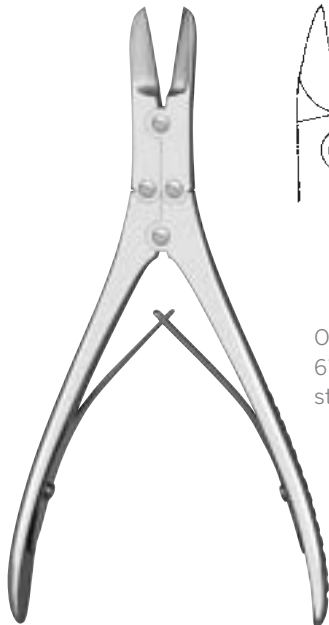

RUSKIN-LISTON FORCEPS

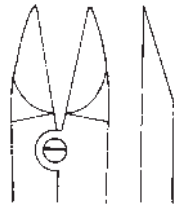

OM 47-0550
6" (152mm)
straight



MCINDOE FORCEPS

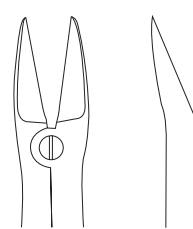

OM 47-0546
7" (178mm)
angled
very delicate blades

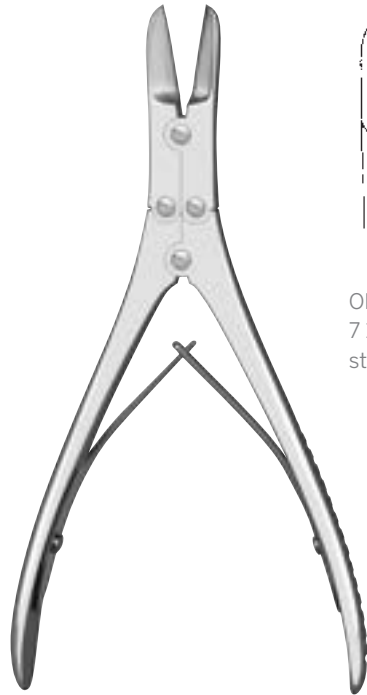

OM 47-0540
7 1/2" (191mm)
straight delicate blades

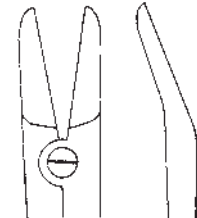
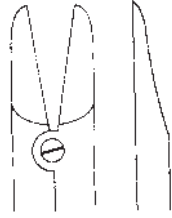

OM 47-0541
7" (178mm)
angled on flat delicate
blades

RUSKIN-LISTON FORCEPS

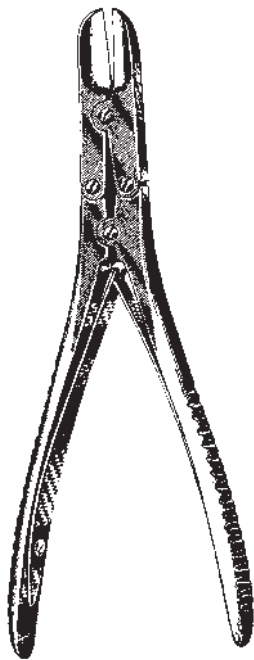

OM 47-0538
7 1/2" (191mm)
straight

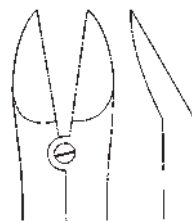
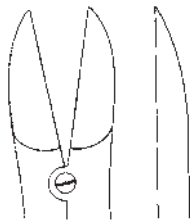

OM 47-0542
7 1/4" (184mm)
angled on flat

RUSKIN-LISTON FORCEPS



STILLE-LISTON FORCEPS

OM 47-0366
10 1/2" (267mm)
straight

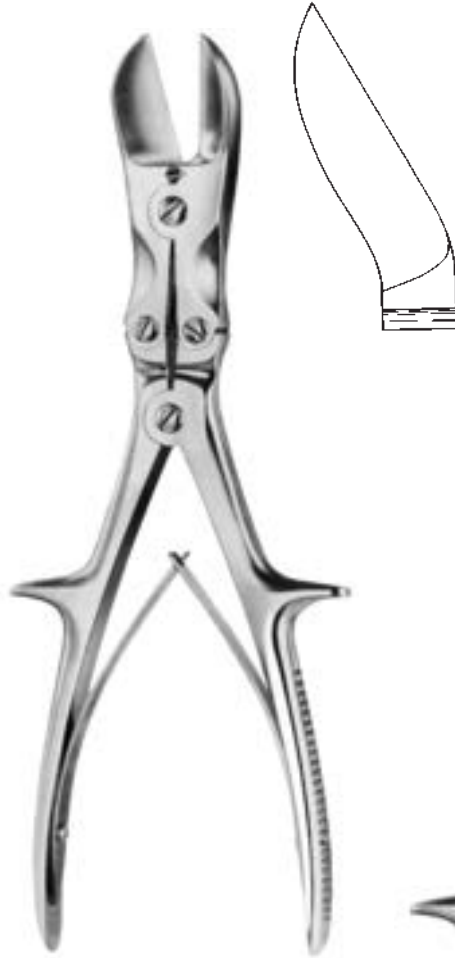

STILLE-LISTON FORCEPS

OM 47-0370
10 1/2" (267mm)
angled on flat



STILLE-HORSLEY FORCEPS

OM 47-0374
10 1/2" (267mm)
angled

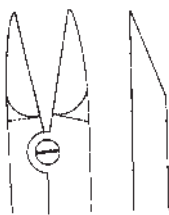
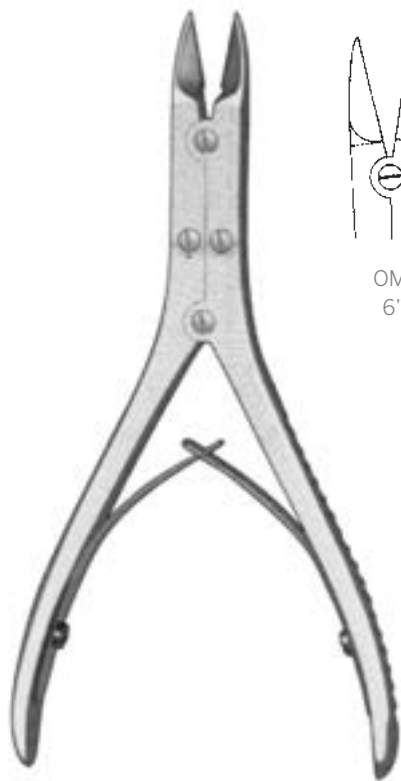

OM 47-0555
6" straight

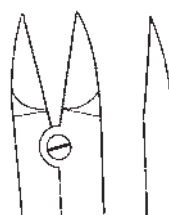

OM 47-0557
6" curved

KLEINERT-KUTZ FORCEPS

6" (152mm) delicate blades

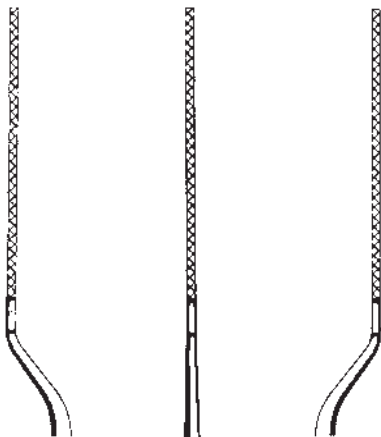

OM 58-0096
OM 58-0097
OM 58-0098

straight
bayonet left
bayonet right

JOSEPH BONE SAW

7" (178mm)



OM 46-0601

LANGENBECK METACARPAL SAW

9" (229mm)

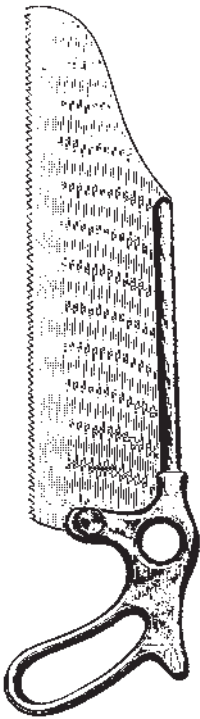

OM 46-0643
11 1/2" (292mm)
complete with ring handle

OM 46-0644
blade only

SATTERLEE BONE SAW



OM 46-0645
10 1/2" (267mm)
complete

OM 46-0646
blade only
chrome

CHARRIERE BONE SAW

Stainless steel frame, chrome blade



OM 46-0683
14" (355mm)
complete

OM 46-0684 12mm
chrome blade only

OM 46-0685 14mm
chrome blade only

CHARRIERE BONE SAW

Stainless steel frame, chrome blades



OM 46-0602
12" (305mm)

PERCY AMPUTATION SHIELD



OM 46-0598 6 3/4" (172mm) blade
 OM 46-0600 8" (203mm) blade

LISTON AMPUTATION KNIFE



Enlarged detail.



OM 46-0612 9" (229mm)
 OM 46-0613 12" (305mm)
 OM 46-0614 20" (508mm)
 OM 46-0615 30" (762mm)

GIGLI SAW BLADES

For cutting hard bone in difficult areas or situations.



OM 46-0616
 loop style
 one pair

OM 46-0610
 loop style
 with snap lock
 one pair



OM 46-0617
 T - style
 2 1/2" (64mm) wide
 one pair

GIGLI SAW HANDLES

3 1/2" (89mm) wide

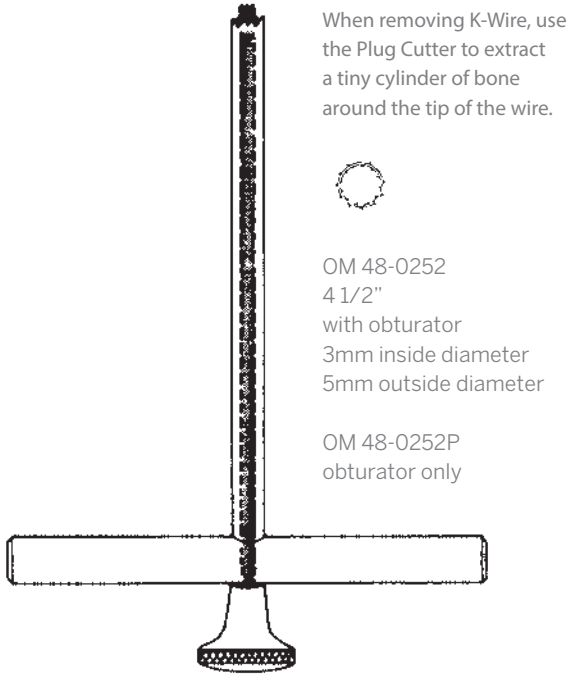

When removing K-Wire, use the Plug Cutter to extract a tiny cylinder of bone around the tip of the wire.



OM 48-0252
4 1/2"
with obturator
3mm inside diameter
5mm outside diameter

OM 48-0252P
obturator only

PLUG CUTTER

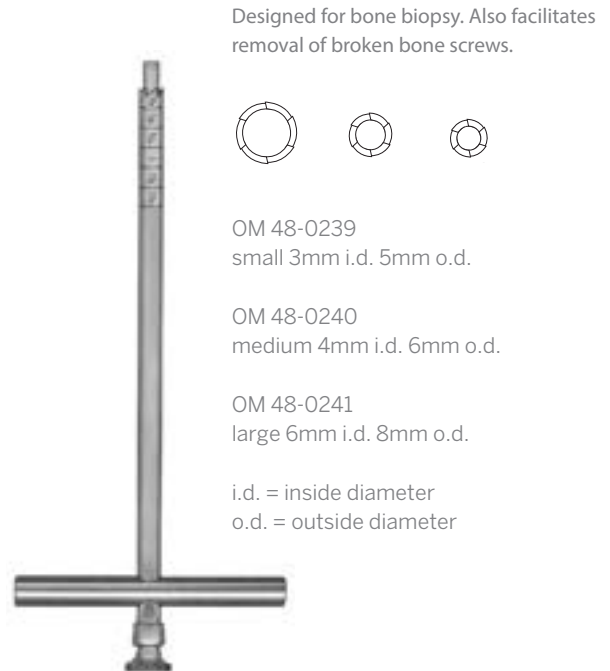

Designed for bone biopsy. Also facilitates removal of broken bone screws.



OM 48-0239
small 3mm i.d. 5mm o.d.

OM 48-0240
medium 4mm i.d. 6mm o.d.

OM 48-0241
large 6mm i.d. 8mm o.d.

i.d. = inside diameter
o.d. = outside diameter

MICHELE TREPHINE

7" (178mm)

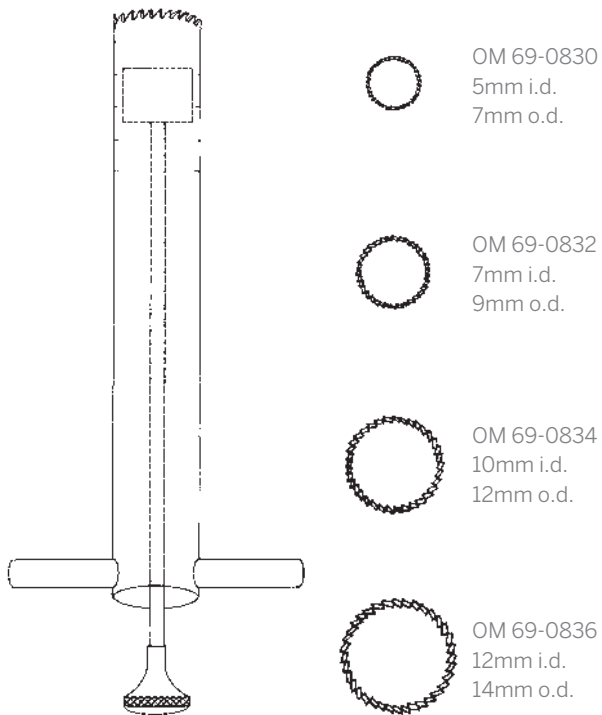

OM 69-0830
5mm i.d.
7mm o.d.



OM 69-0832
7mm i.d.
9mm o.d.



OM 69-0834
10mm i.d.
12mm o.d.



OM 69-0836
12mm i.d.
14mm o.d.

PLUG CUTTER

6" (152mm)

Note:

- These cutters are especially useful for arthrodesis of small and large joints by plug cutter graft technique.
- The plug cutters are designed to be used in pairs.
- The smaller diameter instrument will cut the plug opening and the larger one will harvest a bone graft that will fit into the opening.
- The plug can then be tapped into place using the Bone Impactor (OM 69-0980).

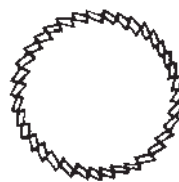

OM 69-0838
20mm i.d.
22mm o.d.

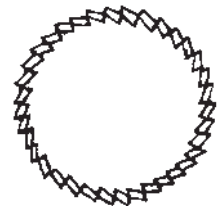

OM 69-0840
22mm i.d.
24mm o.d.

i.d. = inside diameter
o.d. = outside diameter

Bone scraper for cutting strips of bone. They won't be pulverized but they will be cut in slices with exchangeable cutting knives. There is no bone mush and the bone profit will be nearly 100%. The bone scraper is very easy to handle and has a spill box to catch the bone grafts.



BONE SCRAPER INCLUSIVE

OM 60-0110 11" (280mm)
with 3 knives and spill box (1.0, 1.5 and 2.0mm knives)
Length: 28cm | 11,02"

Grinds bones of various densities, producing bone graft of excellent quality for impaction. Two cutting cylinders are included for variable size bone graft.

Attaches securely with table clamp, is fully auto-clavable and easy to dismantle for cleaning.

Includes housing, two cutting cylinders, handle, push block and table clamp.

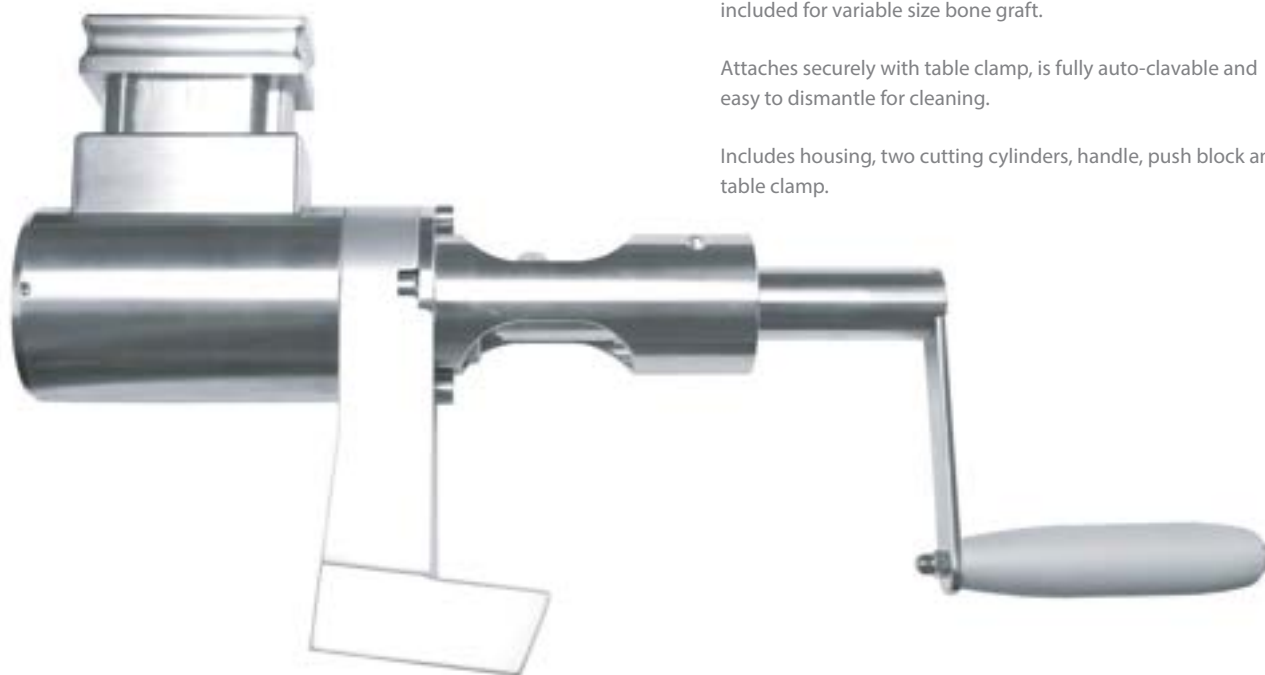

BONE MILL

Used to produce allograft material

- OM 90-8205 Complete unit including 2 cylinders and clamp
- OM 90-8205-01 Replacement cylinder - 3.2mm hole diameter/5 cutting rows
- OM 90-8205-02 Replacement cylinder - 4.2mm hole/4 cutting rows

RONGEURS



SECTION N



To grasp, excise tissue, degenerated disc material, and trim or sculpt bone.

CONTENTS

Rongeurs

1-11

ORTHO+MED
The Surgical Instrument Specialists

For soft tissue and cancellous bone only.

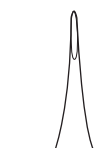
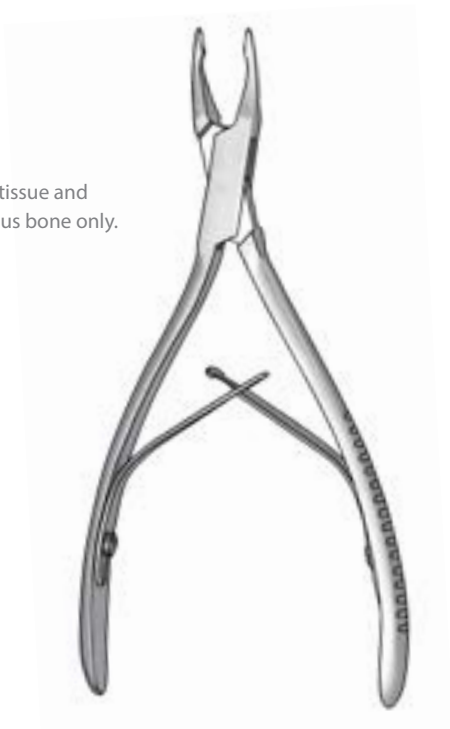

OM 47-0240



OM 47-0242



OM 47-0244

OM 47-0240
OM 47-0242
OM 47-0244

straight 1.5x5mm bite
30° angled 1.5x5mm bite
90° angled 1.5x5mm bite

MICRO FRIEDMAN RONGEUR

Extremely delicate
5 1/2" (152mm)

For soft tissue and cancellous bone only.



OM 47-0252
slight curve
2x5mm bite



OM 47-0253
strong curve
2x5mm bite

SYNOVECTOMY RONGEUR

Extremely delicate
6 3/4" (172mm)

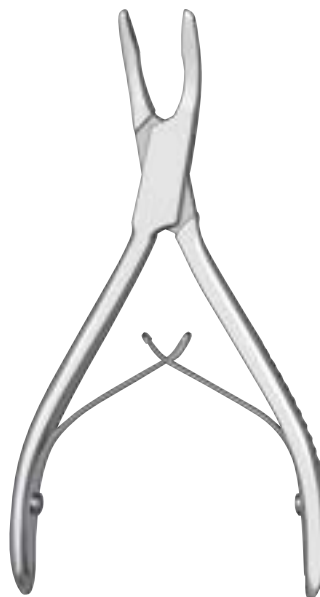

OM 47-0262
5 1/2" (140mm)
curved delicate
4x11mm bite

FRIEDMAN RONGEUR

Curved delicate
5 1/2" (140mm)

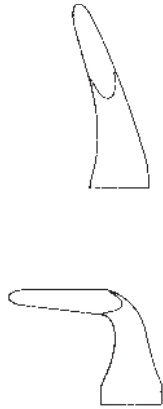

OM 47-0266
30° curved
4x11mm bite

OM 47-0268
90° curved
4x11mm bite

DEAN BLUMENTHAL RONGEUR
6" (152mm)



OM 47-0267
45° curved
4x13mm bite

CHICHIRELLI RONGEUR (BLUMENTHAL)
6" (152mm)



OM 47-0263
straight delicate
2x8mm bite

OM 47-0264
curved delicate
2x8mm bite

MINI FRIEDMAN RONGEUR
6" (152mm)



OM 47-0286
curved
3x10mm bite

DEAN RONGEUR
5 3/4" (146mm)



OM 47-0274
4x9mm bite

RONGEUR #4
5 1/2" (140mm) curved



OM 47-0275
4x7mm bite

RONGEUR #4A
6 1/2" (165mm) curved

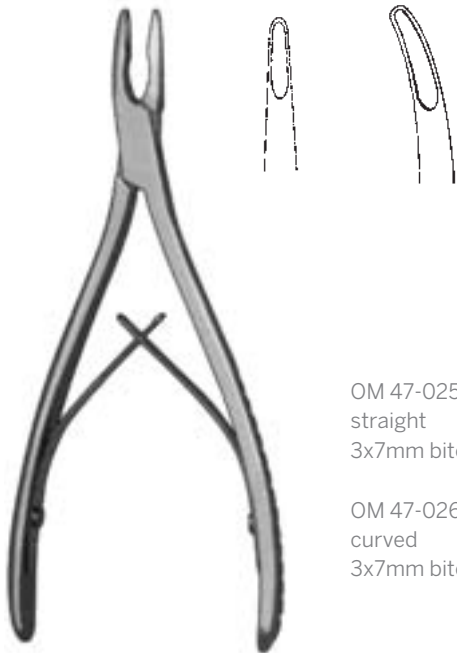

OM 47-0258
straight
3x7mm bite

OM 47-0260
curved
3x7mm bite

LEMPERT RONGEUR
6" (152mm) delicate

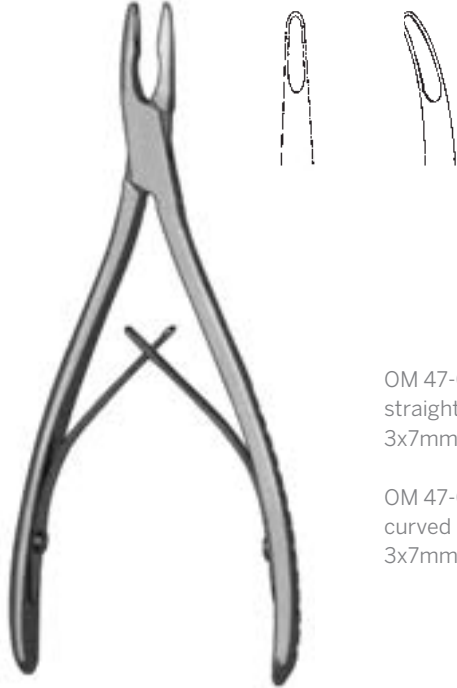

OM 47-0254
straight
3x7mm bite

OM 47-0256
curved
3x7mm bite

LEMPERT RONGEUR
7 1/2" (191mm) delicate

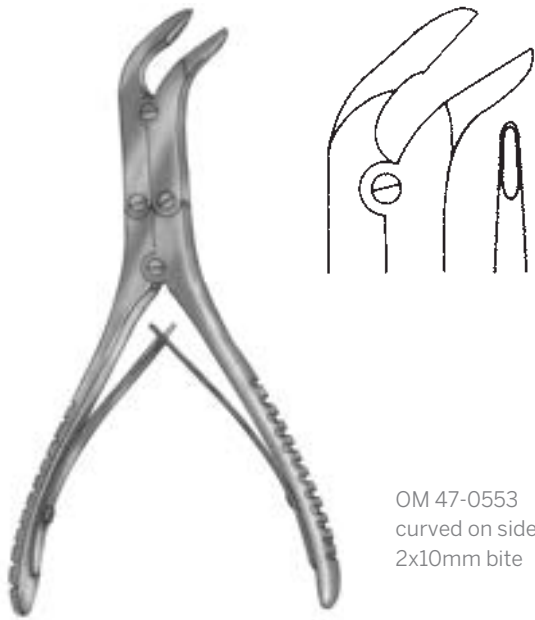

OM 47-0553
curved on side
2x10mm bite

**KLEINERT-KUTZ
SYNOVECTOMY RONGEUR**
6" (152mm) delicate

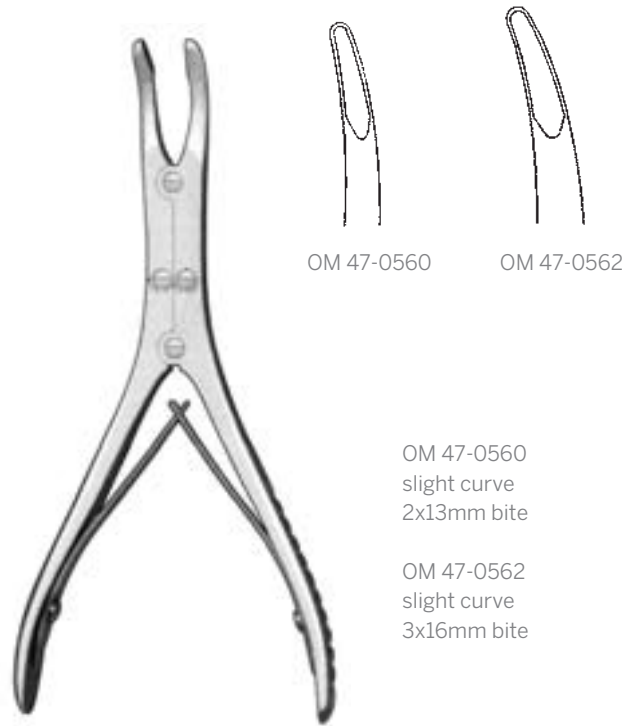

OM 47-0560

OM 47-0562

OM 47-0560
slight curve
2x13mm bite

OM 47-0562
slight curve
3x16mm bite

**KLEINERT-KUTZ
SYNOVECTOMY RONGEUR**
6" (152mm) delicate

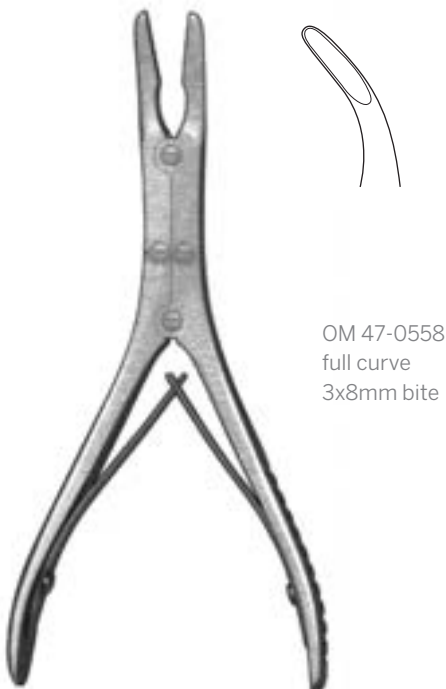

OM 47-0558
full curve
3x8mm bite

**KLEINERT-KUTZ
SYNOVECTOMY RONGEUR**
6" (152mm) delicate

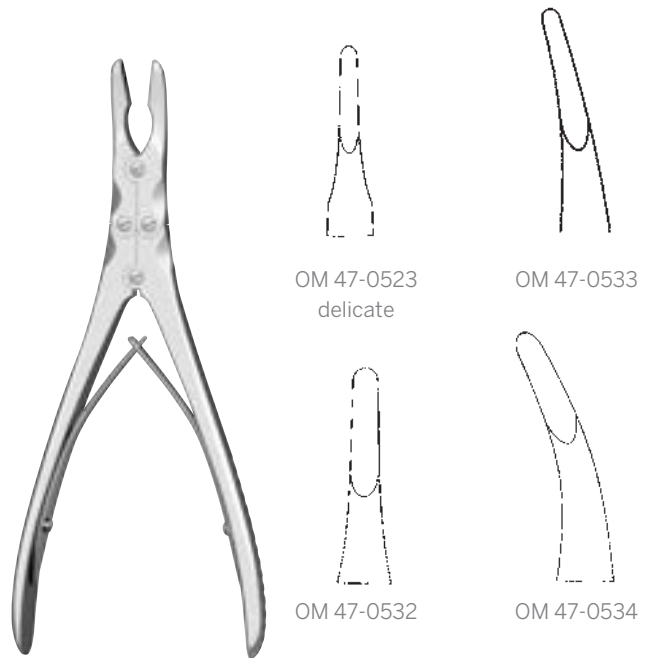

OM 47-0523
delicate

OM 47-0533

OM 47-0532

OM 47-0534

Straight
OM 47-0523 2x14 bite
OM 47-0532 3x15 bite

Curved
OM 47-0533 2x15 bite
OM 47-0534 3x15 bite

RUSKIN RONGEUR
6" (152mm)



Straight
OM 47-0526
4x16mm bite

OM 47-0528
6x16mm bite

Curved
OM 47-0527
4x16mm bite

OM 47-0531
6x16mm bite

RUSKIN RONGEUR
7 1/4" (184mm)

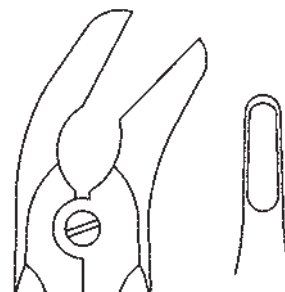
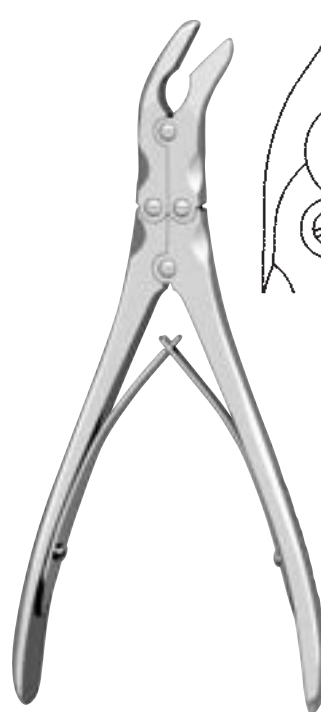

OM 47-0525
5x10mm bite

RUSKIN RONGEUR
7 1/4" (184mm) curved



OM 47-0524
5x15mm bite

ZAUFAL-JANSEN RONGEUR
7" (178mm) curved

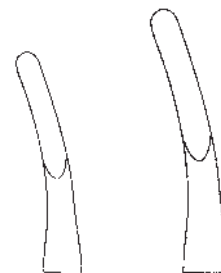

OM 47-0520
3x14mm bite

OM 47-0522
4x15mm bite

BEYER RONGEUR
7" (178mm) curved

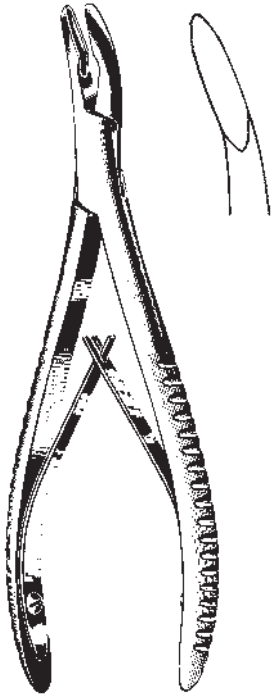

OM 47-0310 7" (178mm)
curved 3x16mm bite

BANE RONGEUR



OM 47-0276 6 1/2" (165mm)
curved 4x13mm bite

MEAD RONGEUR



OM 47-0285 7 1/4" (184mm)
curved 4x16mm bite

HARTMANN RONGEUR



OM 47-0308
5x15mm bite

BACON RONGEUR
8" (203mm) curved on side



Straight
OM 47-0278
8x12mm bite

Curved
OM 47-0284
8x12mm bite

LUER RONGEUR
7" (178mm)

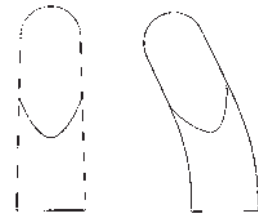

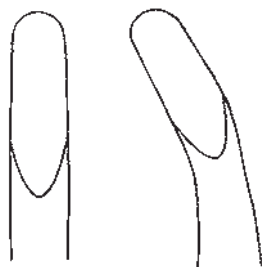
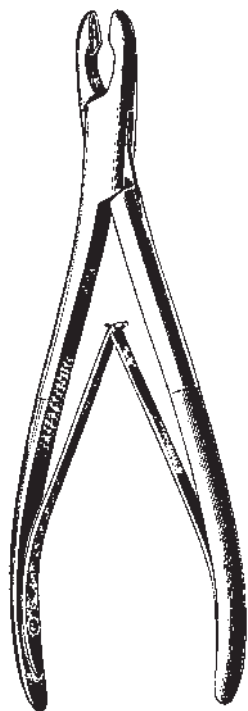

Straight
OM 47-0302
7x15mm bite

Curved
OM 47-0306
7x15mm bite

ADSON RONGEUR
8" (203mm)

Teeth facilitate easier
bone excision.



OM 47-0304
with teeth
8x15mm bite

RAT TOOTH RONGEUR
8" (203mm) straight

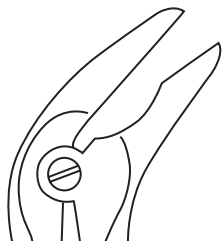

OM 47-0480
2x12mm bite



OM 47-0482
3x12mm bite



OM 47-0484
4x12mm bite

ECHLIN DUCKBILL RONGEUR
9" (229mm) straight, curved on side

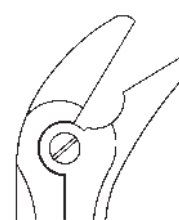



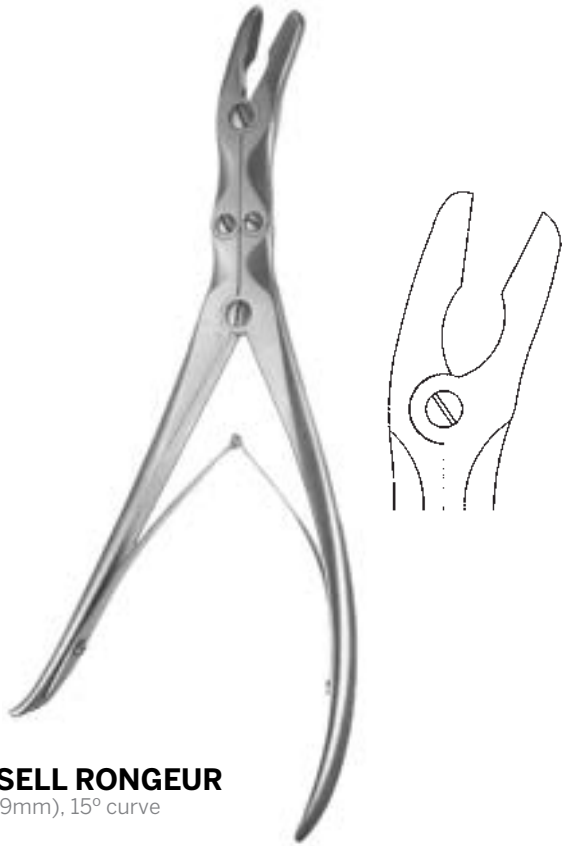

OM 47-0473
6x15mm bite

STILLE-LUER ECHLIN RONGEUR
9" (229mm) straight, curved on side

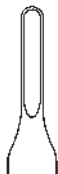

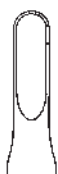



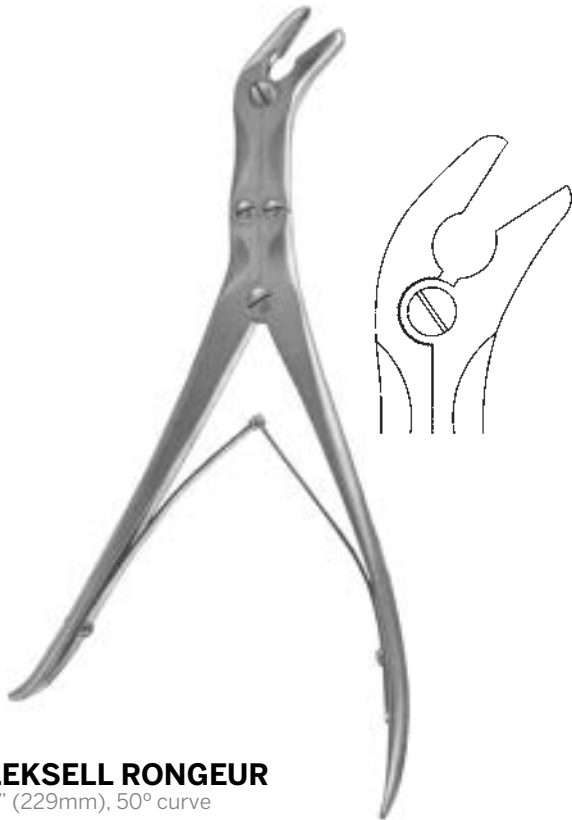

LEKSELL RONGEUR
9" (229mm), 15° curve

- | | | |
|---|---|---|
|  |  |  |
| OM 47-0492
3x16mm bite | OM 47-0486
4x16mm bite | OM 47-0487
5x16mm bite |
|  |  |  |
| OM 47-0488
6x16mm bite | OM 47-0489
7x16mm bite | OM 47-0490
8x16mm bite |

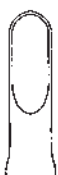

LEKSELL RONGEUR
9" (229mm), 50° curve

- | | | |
|---|---|---|
|  |  |  |
| OM 47-0494
3x13mm bite | OM 47-0495
4x13mm bite | OM 47-0497
5x13mm bite |
|  |  |  |
| OM 47-0498
6x13mm bite | OM 47-0499
7x13mm bite | OM 47-0496
8x16mm bite |

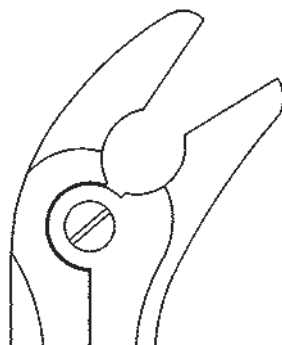

OM 47-0472
curved on side
6x13mm bite

STILLE-LUER DUCKBILL RONGEUR
9" (229mm)

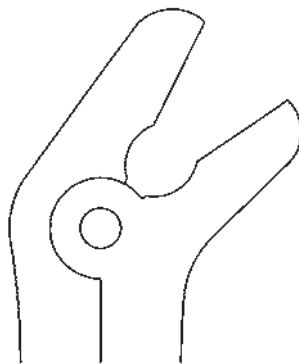

Curved on side
OM 47-0461 8 1/2"

OM 47-0461
10x16mm bite



Straight
OM 47-0458 8 1/2"
OM 47-0462 10 1/2"
10x18mm bite



Curved
OM 47-0460 8 1/2"
OM 47-0464 10 1/2"
10x18mm bite

STILLE-LUER RONGEUR



OM 47-0474
straight
3x16mm bite



OM 47-0476
curved
3x16mm bite

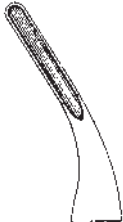
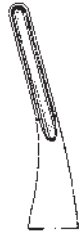

OM 47-0478
fully curved
3x16mm bite

**SMITH-PETERSON
LAMINECTOMY RONGEUR**
9 1/2" (241mm)



OM 47-0396
slight curve
3x16mm bite

DALE THORACIC RONGEUR
14 1/2" (368mm)

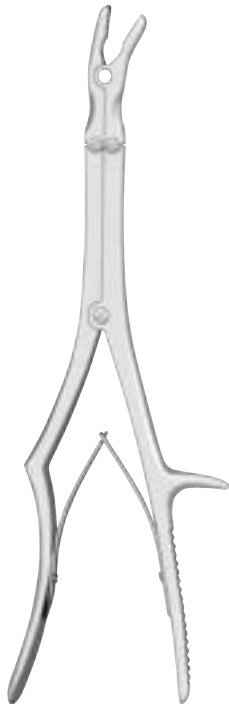

OM 47-0380
4x16mm bite



OM 47-0382
5x16mm bite

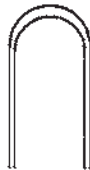

OM 47-0384
8x16mm bite



OM 47-0386
12x16mm bite

SYPERT RONGEUR
14 1/2" (368mm)



OM 55-0990 5mm X 14mm
OM 55-0991 7mm X 16mm
OM 55-0992 10mm X 16mm
8 3/4" handle

ORTHO RONGEUR with PISTOL GRIP

SPINAL RONGEURS AND PUNCHES



SECTION O



To grasp or excise tissue, degenerated disc material or bone during neurological and spinal surgical procedures.

CONTENTS

Identification Chart	1
Handle Styles	2-3
Intervertebral Disc Rongeurs	4-11
Kerrison Punches	12-18
Laminectomy Punches	14-17
Cervical Punches	15
Foramenotomy Punches	16
Endoscopic Punch	18
Swing Apart Ronguers	19
Clean Wave Kerrisons	20

ORTHO+MED
The Surgical Instrument Specialists

IDENTIFICATION CHART

SHAFT LENGTH

Measured in closed position



BITE STYLES

Punch jaws, thin footplate

Forward 40°

Up 90°

Down 90°



BITE STYLES

Punch jaws, regular footplate

Forward 40°

Up 90°

Down 90°

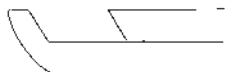

BITE STYLES

Cup jaws

Straight

Up

Down

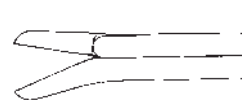

BITE STYLES

Footplate

Bite opening

Bite size

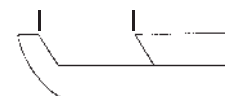
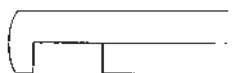

Note: All OrthoMed spinal rongeurs and punches have "bite size" etched on handles for easy identification.

HANDLE STYLES



Style I
Ring handle
Handle height: 4" (102mm)



Style II
Kerrison handle
Handle height: 6 1/4" (159mm)



Style III
Love-Kerrison handle
(Cherry)
Handle height: 6" (152mm)



Style IV
Large Kerrison handle
Handle height: 6 1/4" (159mm)

Note: All OrthoMed spinal rongeurs and punches have "bite size" etched on handles for easy identification.

HANDLE STYLES



Style V
Small Kerrison Handle
Handle height: 5"



Style VI
Ferris-Smith
Kerrison Ring Handle
Handle height: 5"



Style VII
Spurling Kerrison Handle
Wider grip improves comfort and control.
Handle height: 4 3/4"











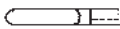

Style VIII
Medium Kerrison Handle
Handle height: 5 1/4"

Note: All OrthoMed spinal rongeurs and punches have "bite size" etched on handles for easy identification.

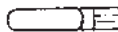
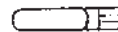
**INTERVERTEBRAL DISC RONGEUR
(HANDLE STYLE I)**



	Straight	Up angle 45°	Down angle 45°
			
	Cushing 1.5x10mm bite straight		
	OM 47-0740		
1/1			
	Cushing 2x10 mm bite straight	Cushing 2x10 mm bite up angle 45°	Cushing 2x10 mm bite down angle 45°
	OM 47-0710 5" OM 47-0730 7" OM 47-0741 9"	OM 47-0712 5" OM 47-0732 7" OM 47-0742 9"	OM 47-0714 5" OM 47-0734 7" OM 47-0744 9"
1/1			
	Love-Gruenwald 3x10 mm bite straight	Love-Gruenwald 3x10 mm bite up angle 45°	Love-Gruenwald 3x10 mm bite down angle 45°
	OM 47-0760 5" OM 47-0780 7"	OM 47-0762 5" OM 47-0782 7"	OM 47-0764 5" OM 47-0784 7"
1/1			
	Spurling 4x10 mm bite straight	Spurling 4x10 mm bite up angle 45°	Spurling 4x10 mm bite down angle 45°
	OM 47-0800 5" OM 47-0840 7"	OM 47-0802 5" OM 47-0842 7"	OM 47-0804 5" OM 47-0844 7"

**CASPAR STYLE
INTERVERTEBRAL DISC RONGEUR
(HANDLE STYLE I)**



Straight



Up angle 45°



Down angle 45°



6" straight
OM 55-0946 2X10mm
OM 55-0947 3X10 mm
OM 55-0948 4X10mm
OM 55-0949 5X10mm



6" up angle 45°
OM 55-0952 2X10mm
OM 55-0953 3X10 mm
OM 55-0954 4X10mm



6" down angle 45°
OM 55-0940 2X10mm
OM 55-0941 3X10 mm
OM 55-0942 4X10mm



6 1/4" straight
Fenestrated jaw, serrated cup
OM 55-0935 2X12mm
OM 55-0936 3X12mm
OM 55-0937 4X14mm
OM 55-0938 5X14mm



7 1/4" up angle 45°
Fenestrated jaw, serrated cup
OM 55-0972 3X12mm
OM 55-0973 4X14mm
OM 55-0974 5X14mm



7 1/4" down angle 45°
Fenestrated jaw, serrated cup
OM 55-0966 3X12mm
OM 55-0967 4X14mm



7 1/4" Straight
Fenestrated jaw, serrated cup
OM 55-0960 2X12mm
OM 55-0961 3X12mm
OM 55-0962 4X14mm
OM 55-0963 5X14mm
OM 55-0964 6X14mm

**FERRIS-SMITH INTERVERTEBRAL DISC RONGEUR
(HANDLE STYLE VI)**

7" (178mm) shaft



Ring handle lessens chance of slippage.

Straight







Up angle 45°





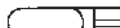

Down angle 45°





7" straight

- 
OM 47-0858 2X10mm
- 
OM 47-0864 3X10 mm
- 
OM 47-0870 4X10
- 
OM 47-0878 6X12mm

7" bite up

- 
OM 47-0860 2X10mm
- 
OM 47-0866 3X10 mm
- 
OM 47-0872 4X10mm
- 
OM 47-0873 6X12mm

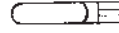
7" bite down

- 
OM 47-0862 2X10mm
- 
OM 47-0868 3X10 mm
- 
OM 47-0874 4X10mm
- 
OM 47-0875 6X12mm

1/1 



OM 55-0842
2x6 mm bite up angle

**PEAPOD INTERVERTEBRAL DISC RONGEUR
(HANDLE STYLE I)**

5 1/2" (140mm) shaft

1/1 



OM 55-0800
3x10 mm bite straight

**TAKAHASHI INTERVERTEBRAL DISC RONGEUR
(HANDLE STYLE I)**

5 1/2" (140mm) shaft



**DECKER INTERVERTEBRAL DISC RONGEUR
(HANDLE STYLE I)**

6" (152mm) shaft



WILDE INTERVERTEBRAL DISC RONGEUR (HANDLE STYLE I)

5" (127mm) shaft
fenestrated jaws straight

1/1 



OM 55-0856
6 mm bite round

**OLDBERG INTERVERTEBRAL DISC RONGEUR
(HANDLE STYLE I)**

7" (178mm) shaft



OM RW4849
2mm with 1X2 teeth

WILLIAMS IVD RONGEUR

5 1/4" (135mm)

SPINAL IVD RONGEURS

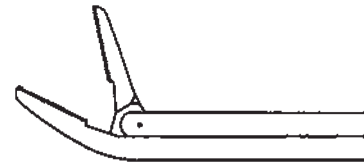
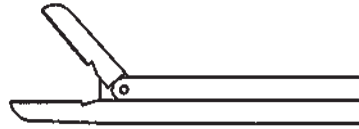

OM 47-0700
2x10 mm bite
straight



OM 47-0702
3x10 mm bite
straight



OM 47-0704
4x10 mm bite
straight



OM 47-0703
3x10 mm bite
up angle



SCHLESINGER INTERVERTEBRAL DISC RONGEUR (HANDLE STYLE I)

6" (152mm) shaft
serrated jaws

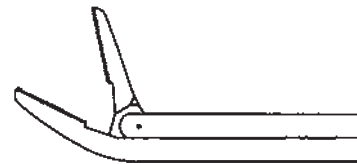
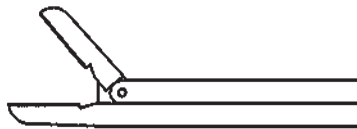

OM 55-0690
3x10 mm bite
straight



OM 55-0691
5x10 mm bite
straight



OM 55-0693
3x10 mm bite
up angle



OM 55-0694
5x10 mm bite
up angle



SCHLESINGER INTERVERTEBRAL DISC RONGEUR (HANDLE STYLE I)

9" (229mm) shaft
serrated jaws

1/1 

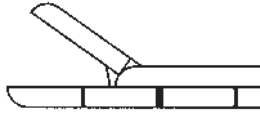

OM 55-0762
2 1/2x10 mm
bite straight

1/1 

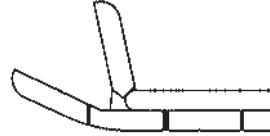

OM 55-0767
4x10 mm
bite up angle

1/1 

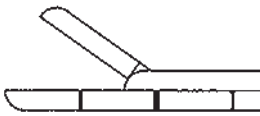

OM 55-0763
4x10 mm
bite straight

1/1 

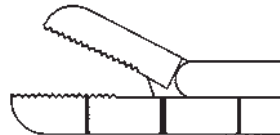

OM 55-0777
8x12 mm
bite straight, serrated

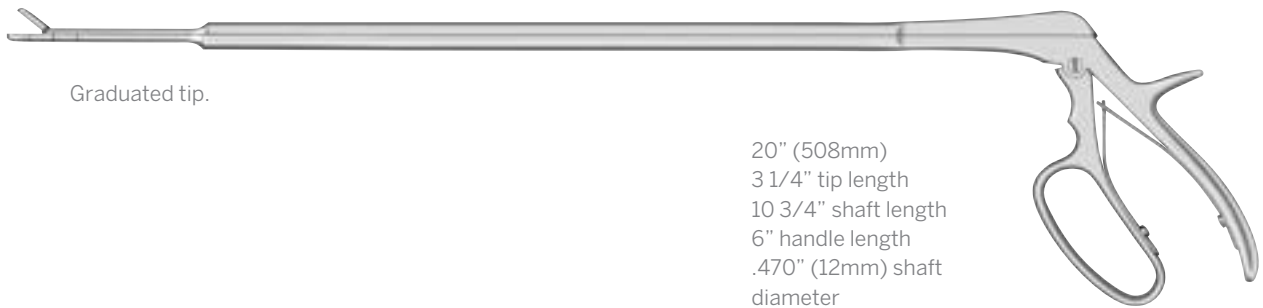

Graduated tip.

20" (508mm)
3 1/4" tip length
10 3/4" shaft length
6" handle length
.470" (12mm) shaft
diameter

**FERRIS-SMITH INTERVERTEBRAL DISC RONGEUR ENDOSCOPIC
(HANDLE STYLE VI)**

SPINAL PUNCHES



Note:

- Thin footplate designed specifically for small bone in the cervical area
- Gold hexagonal screw denotes thin footplate
- "Bite size" etched on handle for quick identification
- Care should be taken when using delicate thin footplate punches
- Do not twist or pry instrument while cutting
- Do not use on large bones

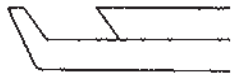

Forward 40° Thin Footplate

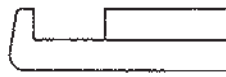

Up 90° Thin Footplate

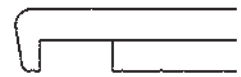

Down 90° Thin Footplate

1/1 □ 1mm bite forward
 OM 55-0891 6" (152mm)
 OM 55-0904 7" (178mm)
 OM 55-0925 8" (203mm)

1/1 □ 1mm bite up
 OM 55-0905 7" (178mm)

1/1 □ 1mm bite down
 OM 55-0906 7" (178mm)

1/1 □ 2mm bite forward
 OM 55-0892 6" (152mm)
 OM 55-0908 7" (178mm)
 OM 55-0926 8" (203mm)

1/1 □ 2mm bite up
 OM 55-0909 7" (178mm)

1/1 □ 2mm bite down
 OM 55-0910 7" (178mm)

1/1 □ 3mm bite forward
 OM 55-0895 6" (152mm)
 OM 55-0911 7" (178mm)
 OM 55-0927 8" (203mm)

1/1 □ 3mm bite up
 OM 55-0912 7" (178mm)

1/1 □ 3mm bite down
 OM 55-0913 7" (178mm)

1/1 □ 4mm bite forward
 OM 55-0898 6" (152mm)
 OM 55-0914 7" (178mm)
 OM 55-0928 8" (203mm)

1/1 □ 4mm bite up
 OM 55-0915 7" (178mm)

1/1 □ 4mm bite down
 OM 55-0916 7" (178mm)

1/1 □ 5mm bite forward
 OM 55-0901 6" (152mm)
 OM 55-0917 7" (178mm)
 OM 55-0929 8" (203mm)

1/1 □ 5mm bite up
 OM 55-0918 7" (178mm)

1/1 □ 5mm bite down
 OM 55-0919 7" (178mm)

1/1 □ 6mm bite forward
 OM 55-0930 8" (203mm)

THIN FOOTPLATE KERRISON PUNCH (HANDLE STYLE V)



Note:

- Thin footplate designed specifically for small bone in the cervical area
- Gold hexagonal screw denotes thin footplate
- "Bite size" etched on handle for quick identification
- Care should be taken when using delicate thin footplate punches
- Do not twist or pry instrument while cutting
- Do not use on large bones

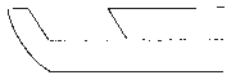



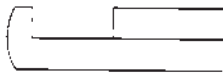













Forward 40° Regular Footplate



Up 90° Regular Footplate



Down 90° Regular Footplate

- | | | | | | |
|-----|--|-----|---|-----|---|
| 1/1 |  1mm bite forward
OM 47-0879 7" (178mm)
OM 48-0015 8" (203mm) | | | | |
| 1/1 |  2mm bite forward
OM 47-0996 7" (178mm)
OM 48-0024 8" (203mm)
OM 47-0685 11" (279mm) | 1/1 |  2mm bite up
OM 47-0988 7" (178mm)
OM 48-0016 8" (203mm) | 1/1 |  2mm bite down
OM 47-0992 7" (178mm)
OM 48-0020 8" (203mm) |
| 1/1 |  3mm bite forward
OM 47-0997 7" (178mm)
OM 48-0025 8" (203mm)
OM 47-0686 11" (279mm) | 1/1 |  3mm bite up
OM 47-0989 7" (178mm)
OM 48-0017 8" (203mm) | 1/1 |  3mm bite down
OM 47-0993 7" (178mm)
OM 48-0021 8" (203mm) |
| 1/1 |  4mm bite forward
OM 47-0998 7" (178mm)
OM 48-0026 8" (203mm)
OM 47-0687 11" (279mm) | 1/1 |  4mm bite up
OM 47-0990 7" (178mm)
OM 48-0018 8" (203mm) | 1/1 |  4mm bite down
OM 47-0994 7" (178mm)
OM 48-0022 8" (203mm) |
| 1/1 |  5mm bite forward
OM 47-0999 7" (178mm)
OM 48-0027 8" (203mm)
OM 47-0688 11" (279mm) | 1/1 |  5mm bite up
OM 47-0991 7" (178mm)
OM 48-0019 8" (203mm) | 1/1 |  5mm bite down
OM 47-0995 7" (178mm)
OM 48-0023 8" (203mm) |
| 1/1 |  6mm bite forward
OM 47-0855 7" (178mm)
OM 48-0028 8" (203mm)
OM 48-0029 11" (279mm) | 1/1 |  6mm bite up
OM 47-0857 7" (178mm) | 1/1 |  6mm bite down
OM 47-0856 7" (178mm) |

**SPURLING KERRISON PUNCH
(HANDLE STYLE V)**

SPINAL PUNCHES

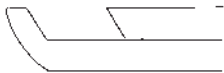

forward 40° Regular Footplate





Up 90° Regular Footplate





Down 90° Regular Footplate

1/1  2mm bite forward
OM 47-0676 8" (203mm)

1/1  3mm bite forward
OM 47-0670 6" (152mm)
OM 47-0678 8" (203mm)

1/1  4mm bite forward
OM 47-0680 8" (203mm)

1/1  5mm bite forward
OM 47-0674 6" (152mm)
OM 47-0682 8" (203mm)

1/1  6mm bite forward
OM 47-0689 11" (279mm)

1/1  3mm bite up
OM 47-0644 6" (152mm)
OM 47-0652 8" (203mm)

1/1  4mm bite up
OM 47-0645 6" (152mm)
OM 47-0853 8" (203mm)

1/1  5mm bite up
OM 47-0646 6" (152mm)
OM 47-0654 8" (203mm)

1/1  3mm bite down
OM 47-0648 6" (152mm)
OM 47-0656 8" (203mm)

1/1  4mm bite down
OM 47-0649 6" (152mm)
OM 47-0657 8" (203mm)

1/1  5mm bite down
OM 47-0650 6" (152mm)
OM 47-0658 8" (203mm)

LOVE-KERRISON LAMINECTOMY PUNCH (HANDLE STYLE IV) LARGE HANDLE



up bite regular footplate

1/1  3mm bite up
OM 47-0610

1/1  5mm bite up
OM 47-0612

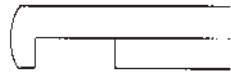

down bite regular footplate

1/1  3mm bite down
OM 47-0614

1/1  5mm bite down
OM 47-0616



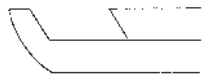

SCHLESINGER CERVICAL LAMINECTOMY PUNCH (HANDLE STYLE IV) LARGE HANDLE

6" (152mm) shaft
regular footplate



forward 40° regular footplate

1/1  3mm bite
OM 55-0813 7"
OM 55-0823 8"

1/1  5mm bite
OM 55-0815 7"
OM 55-0825 8"

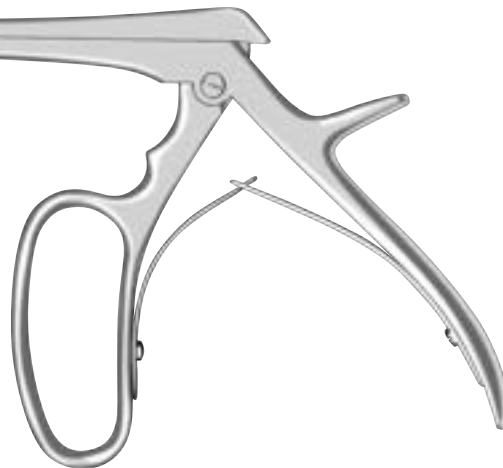

FERRIS SMITH KERRISON PUNCH (HANDLE STYLE V)

Regular footplate

SPINAL PUNCHES

- 1/1  2mm curved bite up
OM 48-0030
- 1/1  3mm curved bite up
OM 48-0033
- 1/1  4mm curved bite up
OM 48-0032

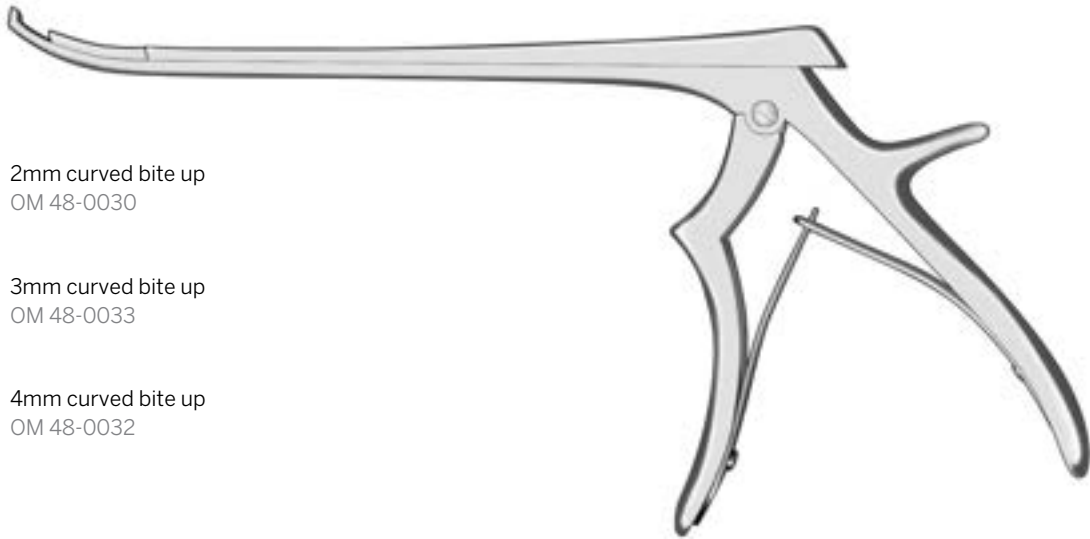

FORAMENOTOMY PUNCH (HANDLE STYLE V)

8" (203mm) shaft
regular footplate

- 1/1 

Fenestrated upper shaft ejects cut pieces of bone and tissue.

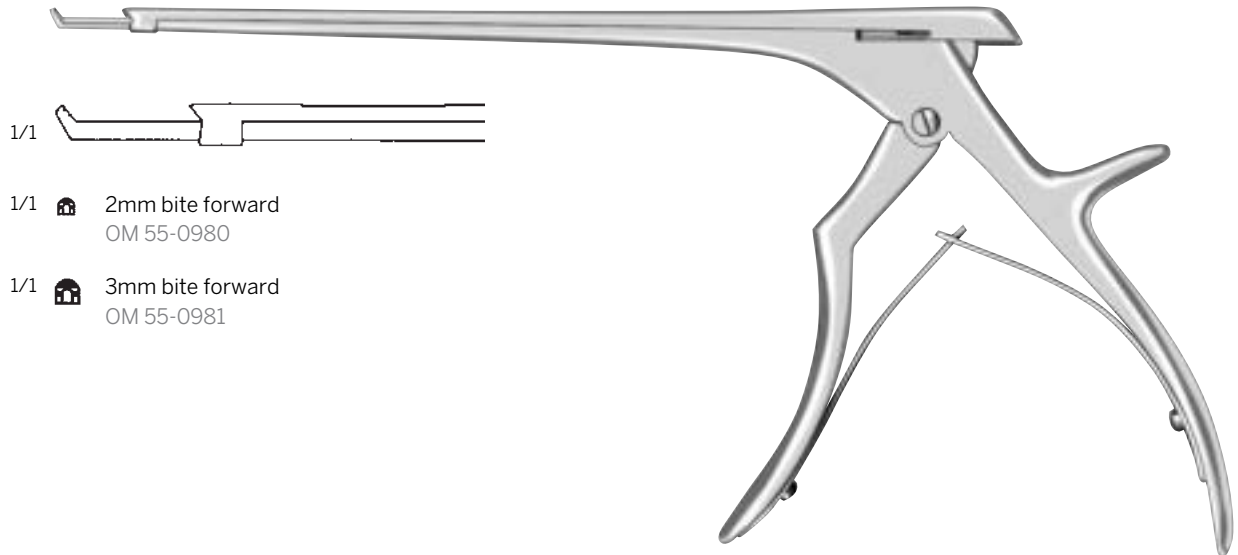

- 1/1 

- 1/1  2mm bite forward
OM 55-0980



- 1/1  3mm bite forward
OM 55-0981

MULTI-BITE KERRISON PUNCH (HANDLE STYLE VIII)

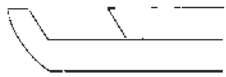
7" (178mm) shaft
delicate thin footplate. For cervical use only.



forward 40° regular footplate

- 1/1  2mm bite
OM 47-0685
- 1/1  3mm bite
OM 47-0686
- 1/1  4mm bite
OM 47-0687
- 1/1  5mm bite
OM 47-0688
- 1/1  6mm bite
OM 48-0029



Compact handle designed to accommodate smaller hands.

SPURLING KERRISON PUNCH (HANDLE STYLE V)

11" (280mm) shaft
regular footplate

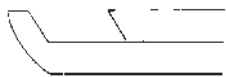

forward 40° regular footplate

- 1/1 



OM 47-0689
11" (280mm) shaft
6mm bite forward
regular footplate

LOVE-KERRISON LAMINECTOMY PUNCH (HANDLE STYLE IV) LARGE HANDLE

Regular footplate

SPINAL PUNCHES

1/1 



OM 55-0788
2.5mm bite forward
forward 40°

1/1 

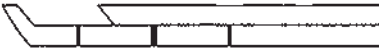

OM 55-0790
4mm bite forward
forward 40°

1/1 



OM 55-0782
4mm bite down
down 90°

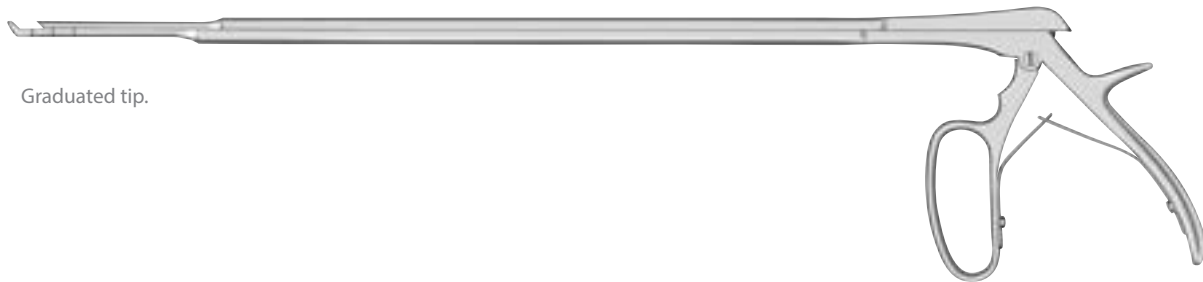

Graduated tip.

20" (508mm)
3 1/4" tip length
10 3/4" shaft length
6" handle length
.470" (12mm) shaft diameter
regular footplate

FERRIS-SMITH KERRISON PUNCH ENDOSCOPIC



40 degree forward with 15mm opening small handle
 OM 59-0111 1mm
 OM 59-0112 2mm
 OM 59-0113 3mm
 OM 59-0114 4mm
 OM 59-0115 5mm
 OM 59-0116 6mm

thin foot plate
 OM 59-0121 1mm
 OM 59-0122 2mm
 OM 59-0123 3mm
 OM 59-0124 4mm
 OM 59-0125 5mm
 OM 59-0126 6mm

FERRIS SMITH KERRISON RONGEUR



OM 59-0313 1mm
 OM 59-0315 2mm
 OM 59-0316 3mm
 OM 59-0321 4mm
 OM 59-0322 5mm

matte black ceramic finish
 OM 59-0313E 1mm
 OM 59-0315E 2mm
 OM 59-0316E 3mm
 OM 59-0321E 4mm
 OM 59-0322E 5mm

SWING APART KERRISON RONGEUR TFP
 8" 40 degree forward

CATCH THE NEW WAVE IN EASY CLEANING.

In most spinal punches, tissue and debris can collect and remain trapped between the main body and slider. This build-up can impede the smooth function of the instrument and prevent proper sterilization as a result of not being completely cleaned prior to sterilization.

The Clean Wave Kerrison Punch has a slider with a wavelike shaped design which allows cleaning brushes easy access through the recesses and openings between the slider and main body for cleaning prior to sterilization.

- Wavelike shape also helps to reduce friction between the slider and main body, providing a smooth function.
- Forward angled foot plate provides precise and controlled cutting action.
- Features a thin foot plate design.
- Bone ejector is incorporated into the design of 2mm-5mm bite sizes.
- Made from German stainless steel.
- Satin finish helps to reduce glare.



CLEAN WAVE KERRISON RONGEUR

8" (203mm)

Ferris-Smith-Kerrison handle, thin foot plate

OM 62-0411	1mm without ejector
OM 62-0412	2mm without ejector
OM 62-0413	3mm without ejector
OM 62-0414	4mm without ejector
OM 62-0415	5mm without ejector

7" (178mm)

Ferris-Smith-Kerrison handle, thin foot plate

OM 62-0221	1mm without ejector
OM 62-0222	2mm without ejector
OM 62-0223	3mm without ejector
OM 62-0224	4mm without ejector
OM 62-0225	5mm without ejector

CARTILAGE AND TENDON INSTRUMENTS



SECTION P



To retrieve, grasp, hold, cut and separate cartilage and tendons.

CONTENTS

Cartilage Instruments	1-2
Tendon Instruments	2-3
Tendon Grasping Forceps	4
Tendon Strippers	5
Cartilage Knives	5
Tissue Graspers	6

ORTHO+MED
The Surgical Instrument Specialists



OM 46-0828
8" (203mm)
two serrated blades

MARTIN CARTILAGE SCISSORS



OM 46-0821
9 1/2" (241mm)
angular

MUELLER CAPSULE SCISSORS



OM 46-0804
7 1/2" (191mm)
angular
2x2 sharp
teeth
serrated jaws

DINGMAN FORCEPS

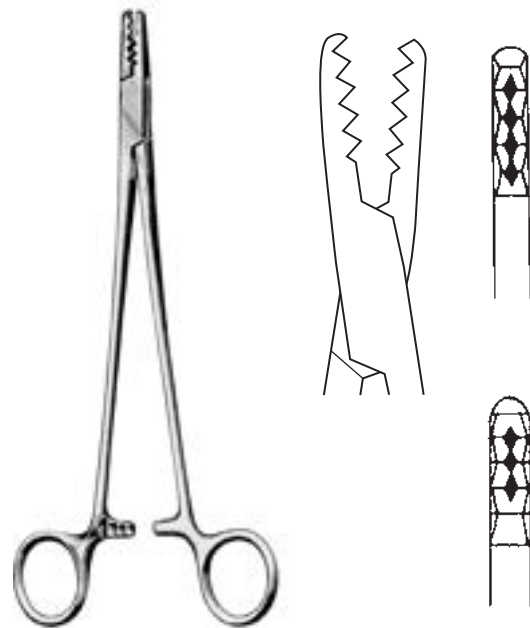

OM 46-0802 7 1/4" (174mm) deep teeth
OM 46-0814 8" (203mm) deep teeth

MARTIN CARTILAGE CLAMP



OM 46-0818
8" (203mm)
slightly curved

WALTON CARTILAGE CLAMP



OM 46-0744
5 3/8" (137mm)
serrated, straight

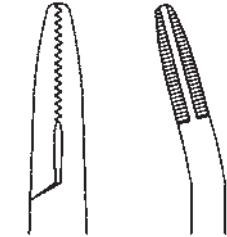

OM 46-0746
5 3/8" (137mm)
serrated, angled 20°

MENISCUS CLAMP

For grasping tags of
the meniscus.

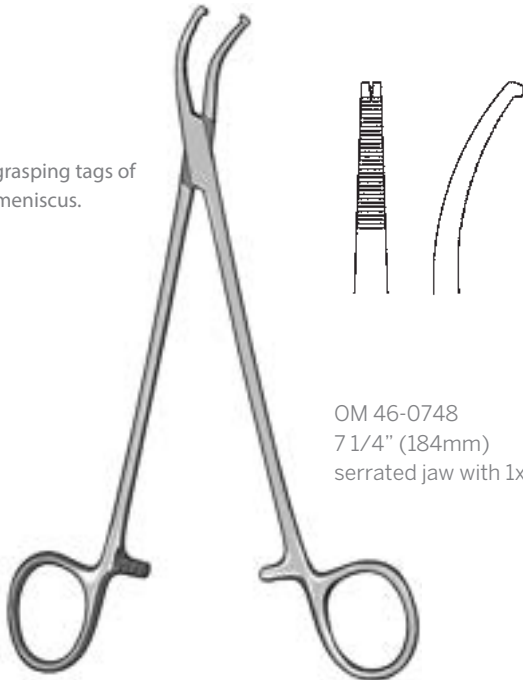

OM 46-0748
7 1/4" (184mm)
serrated jaw with 1x2 tip

**PRESTON LIGAMENTUM FLAVUM
FORCEPS (MENISCUS)**

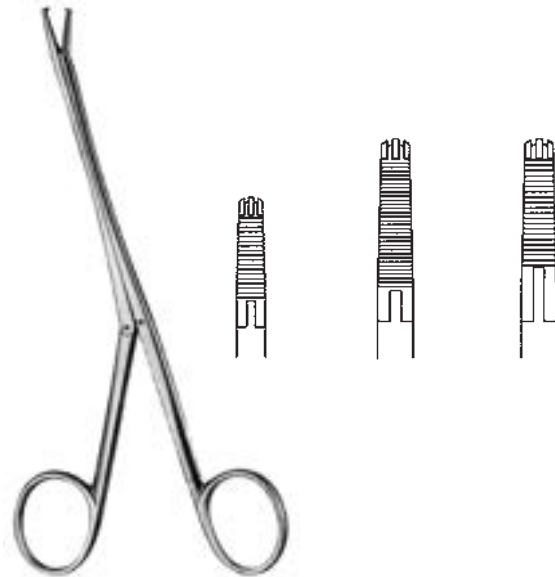

OM 46-0736 6" (152mm) angular shaft
OM 46-0737 7 1/2" (191mm) angular shaft
OM 46-0738 9 1/2" (241mm) angular shaft

BRAND TENDON PULLING FORCEPS



OM 90-1883 sharp
OM 90-1884 blunt

MENISCAL CLAMP 7"



OM 46-0739 8" (203mm)
serrated
with sharp teeth
OM 46-0735 8" (203mm)
serrated
with sharp teeth
flexible shaft

**KLEINERT-KUTZ
TENDON RETRIEVER**

INLET CLOSURE NON-DISPOSABLE

OM 1700040
9 1/2" (241mm)
with cleaning port



CAROLL TENDON PULLING FORCEPS

OM 46-0740
5" (127mm)
curved shaft
serrated



SUTURE GUIDE

OM 6060 10mm
OM 6070 12mm

TENDON GRASPING FORCEPS

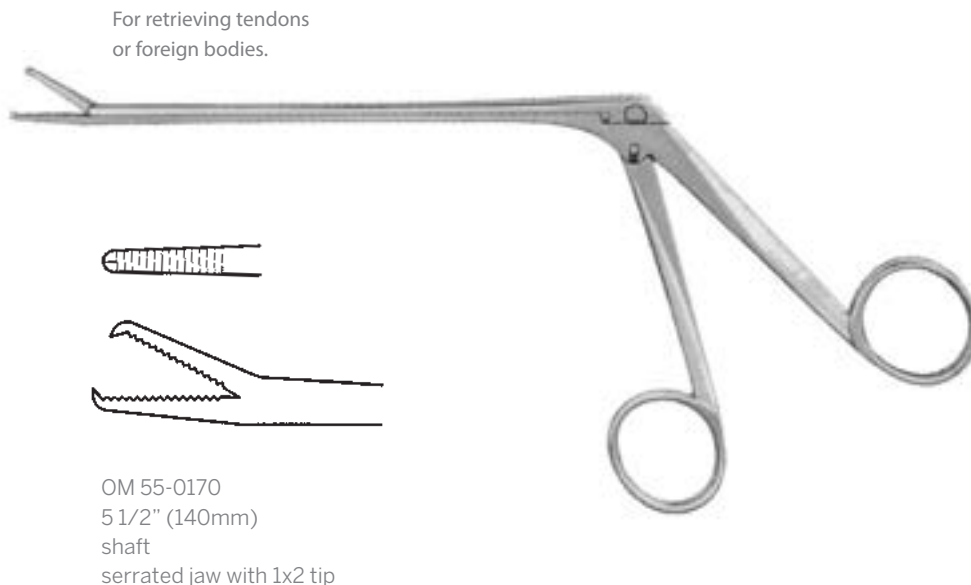

HOEN GRASPING FORCEPS

Designed with one long jaw. Longer jaw extends 5mm and pierces the host tendon. The jaw then grasps the graft. When pulled back it draws the graft through the host to complete the first weave.



OM 46-0742 straight
OM 46-0743 curved

TENDON WEAVING FORCEPS

6 1/4" (159mm)



- OM 46-0730
3mm
- OM 46-0731
4mm
- OM 46-0732
5mm
- OM 46-0733
6mm
- OM 46-0734
7mm

BUNNELL TENDON STRIPPER
6" (152mm)

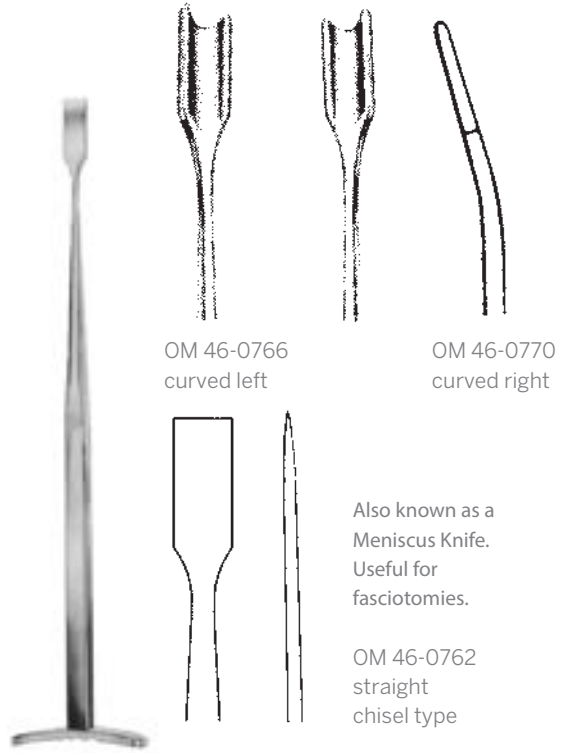

OM 46-0766
curved left

OM 46-0770
curved right

Also known as a
Meniscus Knife.
Useful for
fasciotomies.

OM 46-0762
straight
chisel type

SMILLIE KNIFE
6 3/4" (172mm)



OM 46-0741
10" (254mm)
straight edge with guards
curved blade

**LOWE-BRECK
CARTILAGE KNIFE**

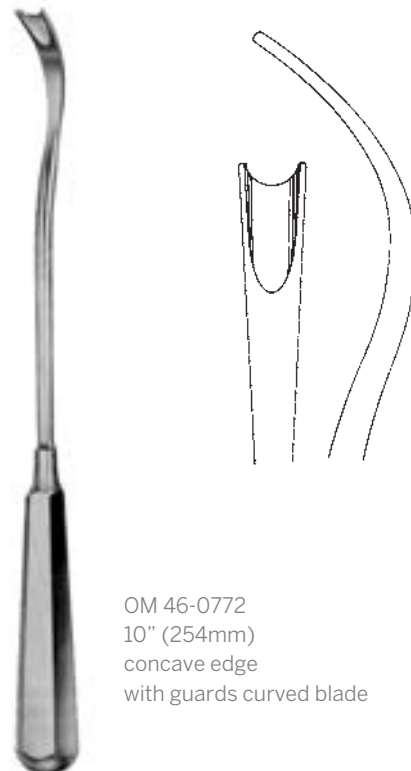

OM 46-0772
10" (254mm)
concave edge
with guards curved blade

DOWNING CARTILAGE KNIFE



CEMENT GRASPER

OM RW8800 9 3/4" overall length (7" shaft, 15mm x 3.5mm cup)



INTRA-ARTICULAR TISSUE GRASPER/RONGEUR

- OM 90-1790-01 8" overall length (5" shaft length)
- OM 90-1790-03 10" overall length (7" shaft length)
- OM 90-1790-02 12" overall length (9" shaft length)



WILLIAMS IVD RONGEUR

5 1/4" (135mm)
OM RW4849
2mm with 1X2 teeth

ARTHROSCOPIC INSTRUMENTS



SECTION Q



To grasp, hold, rotate, excise, trim, and cut ligaments and tendons during arthroscopic procedures.

CONTENTS

Arthroscopic Instruments	1
Biopsy Scissors and Punches	2-8
Grasping Forceps	9
Rinsing Cannula	10
Micro Fracture Picks	10

ORTHO+MED
The Surgical Instrument Specialists



ROUND KNURLED HANDLE

TRI HANDLE

	ROUND KNURLED HANDLE	TRI HANDLE	
MENISCUS PROBE	OM 80-0005 2.5mm	OM 80-0003 3.0mm	
MENISCUS PROBE	OM 80-0010 3.5mm	OM 80-0012 5.0mm	
BAYONET KNIFE	OM 80-0015 OM	OM 80-0017	
SCALPEL KNIFE	OM 80-0020 OM	OM 80-0022	
SMILLIE MENISCOTOME	OM 80-0025 3.0mm	OM 80-0027	
SMILLIE MENISCOTOME	OME OM 80-0030 5.0mm	OM 80-0032	
SMILLIE MENISCOTOME	OME OM 80-0035 7.0mm	OM 80-0036	
RING CURETTE	OM 80-0040 3.0mm	OM 80-0042	
RING CURETTE	OM 80-0045 7.0mm	OM 80-0047	
SPOON	OM 80-0050 3.0mm	OM 80-0053	
BANANA KNIFE	OM 80-0055 smooth	OM 80-0057	
	OM 80-0060 serrated	OM 80-0062	
HOOK KNIFE	OM 80-0065	OM 80-0067	
PLANING KNIFE	OM 80-0070	OM 80-0072	
SICKLE KNIFE	OM 80-0075	OM 80-0077	
ROSETTE KNIFE	OM 80-0080 5.0mm	OM 80-0083	
CARTILAGE FILE	OM 80-0085 fine	OM 80-0087	
SMILLIE MENISCOTOME	OM 80-0090 3.0mm 60° right		
SMILLIE MENISCOTOME	OM 80-0095 3.0mm 60° left		

SCISSORS AND PUNCHES



HANDLE STYLE A



HANDLE STYLE B

Please indicate handle style by adding corresponding letter after part number when placing an order.

Shaft Length 5 1/8" (130mm)	Shaft Diameter	 Hook Scissors	 Hook Punch with Scoop 1.6mm	 Hook Punch Set Down 1.6mm	 Hook Punch Cut Angular 1.6mm
 Straight	2.7mm 3.5mm	OM 80-0100 OM 80-0105	OM 80-0190 OM 80-0195	OM 80-0280 OM 80-0285	OM 80-0370
 30° Right	2.7mm 3.5mm	OM 80-0110 OM 80-0115	OM 80-0200 OM 80-0205	OM 80-0290 OM 80-0295	OM 80-0375
 30° Left	2.7mm 3.5mm	OM 80-0120 OM 80-0125	OM 80-0210 OM 80-0215	OM 80-0300 OM 80-0305	OM 80-0380
 45° Right	2.7mm 3.5mm	OM 80-0130 OM 80-0135	OM 80-0220 OM 80-0225	OM 80-0310 OM 80-0315	OM 80-0385
 45° Left	2.7mm 3.5mm	OM 80-0140 OM 80-0145	OM 80-0230 OM 80-0235	OM 80-0320 OM 80-0325	OM 80-0390
 7° Upward	2.7mm 3.5mm	OM 80-0150 OM 80-0155	OM 80-0240 OM 80-0245	OM 80-0330 OM 80-0335	OM 80-0395
 7° Downward	2.7mm 3.5mm	OM 80-0160 OM 80-0165	OM 80-0250 OM 80-0255	OM 80-0340 OM 80-0345	OM 80-0400
 15° Upward	2.7mm 3.5mm	OM 80-0170 OM 80-0175	OM 80-0260 OM 80-0265	OM 80-0350 OM 80-0355	OM 80-0405
 15° Downward	2.7mm 3.5mm	OM 80-0180 OM 80-0185	OM 80-0270 OM 80-0275	OM 80-0360 OM 80-0365	OM 80-0410















HANDLE STYLE A



HANDLE STYLE B

Please indicate handle style by adding corresponding letter after part number when placing an order.

Shaft Length 5 1/8" (130mm)	Shaft Diameter	 Hook Punch 15° Upwards 1.6mm	 Wide Jaw Punch Large 4.5mm	 Wide Jaw Punch Medium 3.5mm	 Wide Jaw Punch Small 2.5mm
 Straight	3.5mm	OM 80-0415	OM 80-0460	OM 80-0505	OM 80-0550
 30° Right	3.5mm	OM 80-0420	OM 80-0465	OM 80-0510	OM 80-0555
 30° Left	3.5mm	OM 80-0425	OM 80-0470	OM 80-0515	OM 80-0560
 45° Right	3.5mm	OM 80-0430	OM 80-0475	OM 80-0520	OM 80-0565
 45° Left	3.5mm	OM 80-0435	OM 80-0480	OM 80-0525	OM 80-0570
 7° Upward	3.5mm	OM 80-0440	OM 80-0485	OM 80-0530	OM 80-0575
 7° Downward	3.5mm	OM 80-0445	OM 80-0490	OM 80-0535	OM 80-0580
 15° Upward	3.5mm	OM 80-0450	OM 80-0495	OM 80-0540	OM 80-0585
 15° Downward	3.5mm	OM 80-0455	OM 80-0500	OM 80-0545	OM 80-0590

SCISSORS AND PUNCHES















HANDLE STYLE A

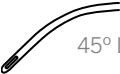

HANDLE STYLE B

Please indicate handle style by adding corresponding letter after part number when placing an order.

Shaft Length 5 1/8" (130mm)	Shaft Diameter	 Wide Jaw Punch 15° Upwards 4.5mm	 Wide Jaw Punch 15° Upwards 3.5mm	 Wide Jaw Punch 15° Upwards 2.5mm	 Wide Jaw Punch 45° Upwards 2.0mm
 Straight	3.5mm	OM 80-0595	OM 80-0640	OM 80-0685	OM 80-0730
 30° Right	3.5mm	OM 80-0600	OM 80-0645	OM 80-0690	
 30° Left	3.5mm	OM 80-0605	OM 80-0650	OM 80-0695	
 45° Right	3.5mm	OM 80-0610	OM 80-0655	OM 80-0700	
 45° Left	3.5mm	OM 80-0615	OM 80-0660	OM 80-0705	
 7° Upward	3.5mm	OM 80-0620	OM 80-0665	OM 80-0710	
 7° Downward	3.5mm	OM 80-0625	OM 80-0670	OM 80-0715	
 15° Upward	3.5mm	OM 80-0630	OM 80-0675	OM 80-0720	
 15° Downward	3.5mm	OM 80-0635	OM 80-0680	OM 80-0725	









HANDLE STYLE A



HANDLE STYLE B

Please indicate handle style by adding corresponding letter after part number when placing an order.

Shaft Length 5 1/8" (130mm)	Shaft Diameter				
Right angled	2.7mm	Punch 45° with Scoop 1.6mm	Punch 45° Blunt 1.6mm	Punch 90° with Scoop 1.6mm	Punch 90° Blunt 1.6mm
		OM 80-0775	OM 80-0785	OM 80-0795	OM 80-0805
Left angled	2.7mm	OM 80-0780	OM 80-0790	OM 80-0800	OM 80-0810

Shaft Length 5 1/8" (130mm)	Shaft Diameter					
Right angled	3.5mm	Hook Scissors 45°	Punch 45° with Scoop 1.6mm	Punch 45° Blunt 1.6mm	Punch 90° with Scoop 1.6mm	Punch 90° Blunt 1.6mm
		OM 80-0815	OM 80-0825	OM 80-0835	OM 80-0845	OM 80-0855
Left angled	3.5mm	OM 80-0820	OM 80-0830	OM 80-0840	OM 80-0850	OM 80-0860

SCISSORS AND PUNCHES



HANDLE STYLE A



HANDLE STYLE B

Please indicate handle style by adding corresponding letter after part number when placing an order.

Shaft Length 5 1/8" (130mm)	Shaft Diameter	Wide Jaw Punch 90° Medium 3.0mm	Wide Jaw Punch 90° Small 2.0mm
Right angled	3.5mm	OM 80-0865	OM 80-0875
Left angled	3.5mm	OM 80-0870	OM 80-0880

Basket punches are available in this handle style in straight, upbite, curved right and left, upswept and many tips and tip sizes. If you would like to check if we offer this handle in the size you need please contact us.



BASKET PUNCH DUCKBILL

OM ATH 0120133
8 3/4" (220mm)
2.7mm straight















HANDLE STYLE A



HANDLE STYLE B

Please indicate handle style by adding corresponding letter after part number when placing an order.

Shaft Length 5 1/8" (130mm)	Shaft Diameter	 Scissors Punch 0.8mm	 Scissors Punch 15° Upwards 0.8mm	 PunchRetrograde Cut Left 2.5mm	 PunchRetrograde Cut Right 2.5mm
 Straight	3.5mm	OM 80-0885	OM 80-0912	OM 80-0930	OM 80-0932
 30° Right	3.5mm	OM 80-0890	OM 80-0914		
 30° Left	3.5mm	OM 80-0895	OM 80-0916		
 45° Right	3.5mm	OM 80-0900	OM 80-0918		
 45° Left	3.5mm	OM 80-0902	OM 80-0920		
 7° Upward	3.5mm	OM 80-0904	OM 80-0922		
 7° Downward	3.5mm	OM 80-0906	OM 80-0924		
 15° Upward	3.5mm	OM 80-0908	OM 80-0926		
 15° Downward	3.5mm	OM 80-0910	OM 80-0928		

SCISSORS AND PUNCHES



HANDLE STYLE A



HANDLE STYLE B



HANDLE STYLE C

Please indicate handle style by adding corresponding letter after part number when placing an order.

Shaft Length 5 1/8" (130mm)	Shaft Diameter	 Grasping Forceps	 Grasping Forceps 1 x 2 Teeth	 Grasping Forceps 1 x 2 Teeth	 Grasping and Biopsy Forceps
without Ratchet	2.7mm	OM 80-0934	OM 80-0938	OM 80-0942	OM 80-0946
with Ratchet	2.7mm	OM 80-0936	OM 80-0940	OM 80-0944	OM 80-0948

Shaft Length 5 1/8" (130mm)	Shaft Diameter	 Grasping Forceps	 Grasping Forceps 1 x 2 Teeth	 Grasping Forceps 1 x 2 Teeth	 Grasping and Biopsy Forceps	 Biopsy Spoon Forceps
without Ratchet	3.5mm	OM 80-0950	OM 80-0954	OM 80-0958	OM 80-0962	OM 80-0966
with Ratchet	3.5mm	OM 80-0952	OM 80-0956	OM 80-0960	OM 80-0964	OM 80-0968

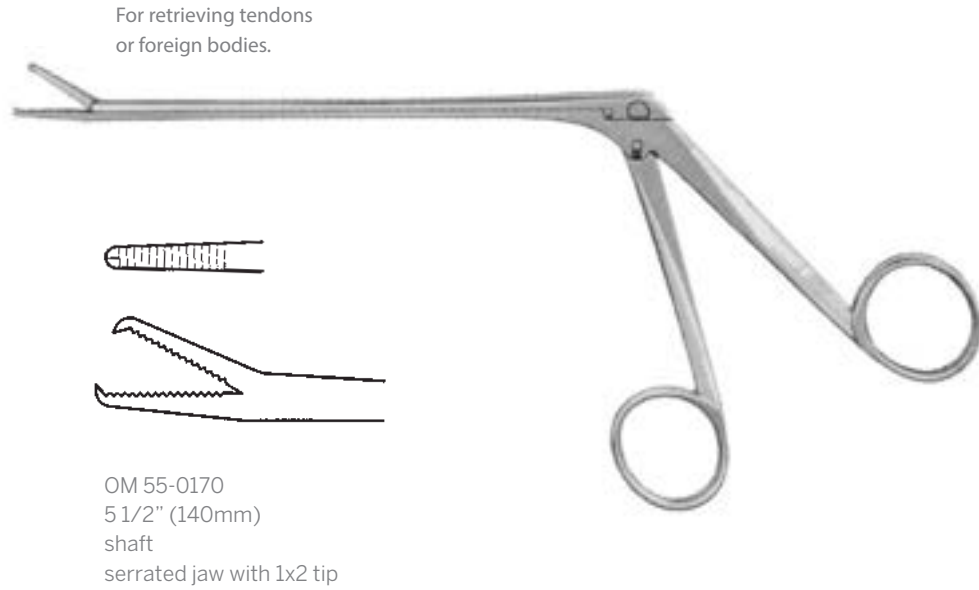

HOEN GRASPING FORCEPS



LOOSE BODY GRASPER



RINSING CANNULA with STOPCOCK

OM TO 579-260-00 Complete Set 3.2mm
Includes Cannula with Stopcock with Sharp and Blunt Trocar

OM TO 579-270-00 Complete Set 4.5mm
Includes Cannula with Stopcock with Sharp and Blunt Trocar

OM TO 579-260-01 Cannula Only 3.2mm
OM TO 579-260-02 Trocar Pyramidal
OM TO 579-260-03 Trocar Blunt

OM TO 579-270-01 Cannula Only 4.5mm
OM TO 579-270-02 Trocar Pyramidal
OM TO 579-270-03 Trocar Blunt



Picks feature an ergonomic carbon fiber handle with integrated impact protection for use with mallet. 5 different tip angles give surgeon full flexibility in micro fracture approaches.

MICRO FRACTURE CHONDRO PICKS

OM 89-0310 Straight tip
OM 89-0313 25 degree tip
OM 89-0316 40 degree tip
OM 89-0318 60 degree tip
OM 89-0319 90 degree tip

WIRE AND PIN IMPLANTS



SECTION R



To aid in alignment, reduction, and fixation of fractured bone.

CONTENTS

Kirschner Wire	1
Steinmann Pin	2
Guide Wires	3
Shanz Pin	3
Cerclage Wire	3
Jurgan Pin Balls and General Set	4
Wire & Pin Sterilization Container	5-8
TKA Cutting Block Fixation Pins	9

Note: An internal fixation device must never be reused.

ORTHO+MED
The Surgical Instrument Specialists

ORTHOMED WIRE AND PIN IMPLANTS

- Precision manufactured in Germany from certified implant stainless steel.
- Longer, gently tapered points for easier penetration.
- Smoothly hand polished, causing less trauma when removed.
- K-Wire and Steinmann pins are sold six (6) to a package.

Please inquire about the availability of any sizes and styles not shown in the catalog.

KIRSCHNER WIRES SMOOTH

LENGTH	DIAMETER AND PRODUCT NUMBER				
	.028" (.7mm)	.035" (.9mm)	.045" (1.1mm)	.054" (1.4mm)	.062" (1.6mm)

DOUBLE END TROCAR

4"	OM 71-0100	OM 71-0101	OM 71-0102	OM 71-0104	OM 71-0103
5"	OM 71-0105	OM 71-0106	OM 71-0107	OM 71-0108	OM 71-0109
6"	OM 71-0021	OM 71-0022	OM 71-0023	OM 71-0024	OM 71-0025
9"	OM 71-0110	OM 71-0111	OM 71-0112	OM 71-0114	OM 71-0113
12"	OM 71-0120	OM 71-0121	OM 71-0122	OM 71-0124	OM 71-0123

SINGLE TROCAR Round end

4"	OM 71-0130	OM 71-0131	OM 71-0132	OM 71-0133	OM 71-0134
5"	OM 71-0170	OM 71-0171	OM 71-0172	OM 71-0174	OM 71-0175
6"	OM 71-0178	OM 71-0180	OM 71-0182	OM 71-0183	OM 71-0185
9"	OM 71-0150	OM 71-0151	OM 71-0152	OM 71-0154	OM 71-0153
12"	OM 71-0160	OM 71-0161	OM 71-0162	OM 71-0164	OM 71-0163

DOUBLE END DIAMOND

4"	OM 71-0200	OM 71-0201	OM 71-0202	OM 71-0203	OM 71-0204
5"	OM 71-0205	OM 71-0206	OM 71-0207	OM 71-0208	OM 71-0209
6"	OM 71-0030	OM 71-0031	OM 71-0032	OM 71-0034	OM 71-0033
9"	OM 71-0210	OM 71-0211	OM 71-0212	OM 71-0214	OM 71-0213

SINGLE DIAMOND Round end

4"	OM 71-0230	OM 71-0231	OM 71-0232	OM 71-0233	OM 71-0234
9"	OM 71-0240	OM 71-0241	OM 71-0242	OM 71-0244	OM 71-0243
12"	OM 71-0250	OM 71-0251	OM 71-0252	OM 71-0254	OM 71-0253

SUTURE PASSER SINGLE DIAMOND With suture hole

9"	—	—	OM 71-0262	—	OM 71-0263
----	---	---	------------	---	------------

KIRSCHNER WIRE FULLY THREADED

LENGTH	DIAMETER AND PRODUCT NUMBER			
	—	—	—	.062" (1.6mm)

DOUBLE END TROCAR

6"	—	—	—	OM 71-0293
9"	—	—	—	OM 71-0303

SINGLE TROCAR

9"	—	—	—	OM 71-0310
----	---	---	---	------------

DOUBLE END DIAMOND

9"	—	—	—	OM 71-0313
----	---	---	---	------------

SINGLE DIAMOND

9"	—	—	—	OM 71-0307
----	---	---	---	------------



Bend K-Wire up to .062" in diameter easily with our Gratloch™ Wire Bender OM 48-0370. See Section S.

Drawings shown on this page are not actual size.

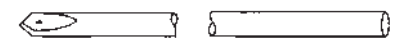

STEINMANN PINS

STEINMANN PINS SMOOTH

LENGTH	DIAMETER AND PRODUCT NUMBER							
	5/64" (2.0mm)	3/32" (2.4mm)	7/64" (2.8mm)	1/8" (3.2mm)	9/64" (3.5mm)	5/32" (4.0mm)	.177" (4.5mm)	3/16" (4.8mm)

DOUBLE END TROCAR

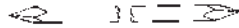

9"	OM 71-0450	OM 71-0453	OM 71-0456	OM 71-0459	OM 71-0462	OM 71-0465	OM 71-0468	OM 71-0469
----	------------	------------	------------	------------	------------	------------	------------	------------

SINGLE TROCAR Round end

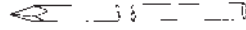

9"	OM 71-0510	OM 71-0513	OM 71-0516	OM 71-0519	OM 71-0522	OM 71-0525	OM 71-0528	OM 71-0529
12"	OM 71-0674	OM 71-0676	OM 71-0677	OM 71-0680	OM 71-0681	OM 71-0682	OM 71-0683	—

DOUBLE END DIAMOND

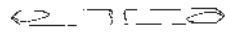

9"	OM 71-0600	OM 71-0603	OM 71-0606	OM 71-0609	OM 71-0612	OM 71-0615	OM 71-0618	OM 71-0619
----	------------	------------	------------	------------	------------	------------	------------	------------

SINGLE DIAMOND Round end

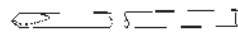

9"	OM 71-0660	OM 71-0663	OM 71-0666	OM 71-0669	OM 71-0672	OM 71-0675	OM 71-0678	OM 71-0679
----	------------	------------	------------	------------	------------	------------	------------	------------

SINGLE TROCAR 3 shank end

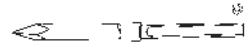

9"	OM 71-0480	OM 71-0483	OM 71-0486	OM 71-0489	OM 71-0492	OM 71-0495	OM 71-0498	—
----	------------	------------	------------	------------	------------	------------	------------	---

SINGLE DIAMOND 3 shank end

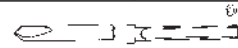

9"	OM 71-0630	OM 71-0633	OM 71-0636	OM 71-0639	OM 71-0642	OM 71-0645	OM 71-0648	—
----	------------	------------	------------	------------	------------	------------	------------	---

SINGLE DIAMOND With suture hole, 3 shank end

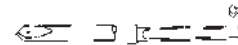

9"	OM 71-0880	OM 71-0883	OM 71-0886	OM 71-0889	OM 71-0892	OM 71-0895	OM 71-0898	—
----	------------	------------	------------	------------	------------	------------	------------	---

STEINMANN PINS FULLY THREADED

LENGTH	DIAMETER AND PRODUCT NUMBER							
	5/64" (2.0mm)	3/32" (2.4mm)	7/64" (2.8mm)	1/8" (3.2mm)	9/64" (3.5mm)	5/32" (4.0mm)	.177" (4.5mm)	3/16" (4.8mm)

DOUBLE END TROCAR



9"	OM 71-0750	OM 71-0753	OM 71-0756	OM 71-0759	OM 71-0762	OM 71-0765	OM 71-0768	OM 71-0769
----	------------	------------	------------	------------	------------	------------	------------	------------

SINGLE TROCAR Round end



9"	OM 71-0770	OM 71-0773	OM 71-0776	OM 71-0779	OM 71-0782	OM 71-0785	OM 71-0788	OM 71-0789
----	------------	------------	------------	------------	------------	------------	------------	------------

DOUBLE END DIAMOND



9"	OM 71-0730	OM 71-0733	OM 71-0736	OM 71-0739	OM 71-0742	OM 71-0745	OM 71-0748	OM 71-0749
----	------------	------------	------------	------------	------------	------------	------------	------------

SINGLE DIAMOND Round end



9"	OM 71-0700	OM 71-0703	OM 71-0706	OM 71-0709	OM 71-0712	OM 71-0715	OM 71-0718	OM 71-0719
----	------------	------------	------------	------------	------------	------------	------------	------------

Drawings shown on this page are not actual size.

STEINMANN PINS CALIBRATED (GUIDE WIRES) with 1/2" graduations

LENGTH	DIAMETER AND PRODUCT NUMBER			
	5/64" (2.0mm)	3/32" (2.4mm)	7/64" (2.8mm)	1/8" (3.2mm)

SINGLE TROCAR 3 shank end

9"	—	OM 71-0833	—	—
----	---	------------	---	---



SINGLE DIAMOND 3 shank end

9"	—	OM 71-0853	OM 71-0856	OM 71-0859
----	---	------------	------------	------------



SINGLE DIAMOND Round end

9"	—	OM 71-0873	—	—
----	---	------------	---	---



SCHANZ PINS (Partially Threaded)

PRODUCT NUMBER	OVERALL LENGTH	THREAD LENGTH	DIAMETER
OM 72-0220	6"	45mm	5mm
OM 72-0222	6 3/4"	45mm	5mm
OM 72-0230	7 1/2"	45mm	5mm
OM 72-0224	8"	45mm	5mm
OM 72-0226	10"	45mm	5mm

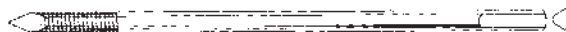

CERCLAGE WIRE 10 meters in length

PRODUCT NUMBER	DIAMETER	APPROX. GAUGE
OM 72-0102	0.2mm	36
OM 72-0103	0.3mm	30
OM 72-0104	0.4mm	27
OM 72-0105	0.5mm	25
OM 72-0106	0.6mm	23
OM 72-0107	0.7mm	22
OM 72-0108	0.8mm	21
OM 72-0109	0.9mm	20
OM 72-0110	1.0mm	19
OM 72-0112	1.2mm	18
OM 72-0115	1.5mm	17
OM 72-0116	1.8mm	13





**JURGAN REFILL RACKS
STANDARD WHITE**

W-Series pin balls

Six balls of one size per rack

OM JR-W028	.028" (.7mm)
OM JR-W035	.035" (.9mm)
OM JR-W045	.045" (1.1mm)
OM JR-W062	.054" -.062" (1.6mm)
OM JR-W564	5/64" (2mm, .065")
OM JR-W332	3/32" (2.5mm)

**JURGAN REFILL RACKS
COLOR CODED**

W-Series pin balls

Six balls of one size per rack

(red, dark blue, yellow, green, light blue, cream)

OM JR-W028-RD	.028" (.7mm)
OM JR-W035-DB	.035" (.9mm)
OM JR-W045-YL	.045" (1.1mm)
OM JR-W062-GN	.054" -.062" (1.6mm)
OM JR-W564-LBL	5/64" (2mm, .065")
OM JR-W332-CR	3/32" (2.5mm)



JURGAN SCREWDRIVER

Standard - for use with W and X series balls
OM JR-S200



JURGAN PIN BALL GENERAL SET

For capping K-Wires
OM JR-C50 standard white

Set includes:

OM JR-W045	.045" (1.1mm)
OM JR-W062	.054" -.062" (1.6mm)
OM JR-W564	5/64" (2mm, .065")
OM JR-W332	3/32" (2.5mm)
OM JR-S200	Screwdriver
OM JR-C10	Sterilization Case

OM JR-C50-COL Colored Set

Set includes:

OM JR-W045-YL	.045" (1.1mm)
OM JR-W062-GN	.054" -.062" (1.6mm)
OM JR-W564-LBL	5/64" (2mm, .065")
OM JR-W332-CR	3/32" (2.5mm)
OM JR-S200	Screwdriver
OM JR-C10-COL	Sterilization Case



Designed to provide easy access and identification.

The OrthoMed K-Wire and Steinmann Pin Sterilization Case holds popular 4" (102mm), 6" (152mm) and 9" (229mm) K-Wires and 9" (229mm) Steinmann Pins.

Accommodates four each of the following

K-Wire diameters:

- .028" (.7mm)
- .035" (.9mm)
- .045" (1.1mm)
- .062" (1.6mm)

Accommodates two each of the following

Steinmann Pin diameters:

- 5/64" (2.0mm)
- 3/32" (2.4mm)
- 7/64" (2.8mm)
- 1/8" (3.2mm)
- 9/64" (3.5mm)
- 5/32" (4.0mm)
- .177" (4.5mm)

- Removable lid fits under case – taking up less room in the O.R.
- Nylon coated brackets prevent metal-to-metal contact – protecting sharp ends.
- Contents are held in place when closed – preventing shifting.
- Secure locking side brackets help prevent accidental opening.
- Handles at each end for easy transport.
- Anodized aluminum case is lightweight and built to withstand abuse.
- Fully autoclavable to 270°F (132°C).

ORTHOMED K-WIRE AND STEINMANN PIN STERILIZATION CASE

OM 71-0010

11 3/4" x 5 1/4" x 2" (closed)

(298mm x 133mm x 51mm)



Case in closed position.

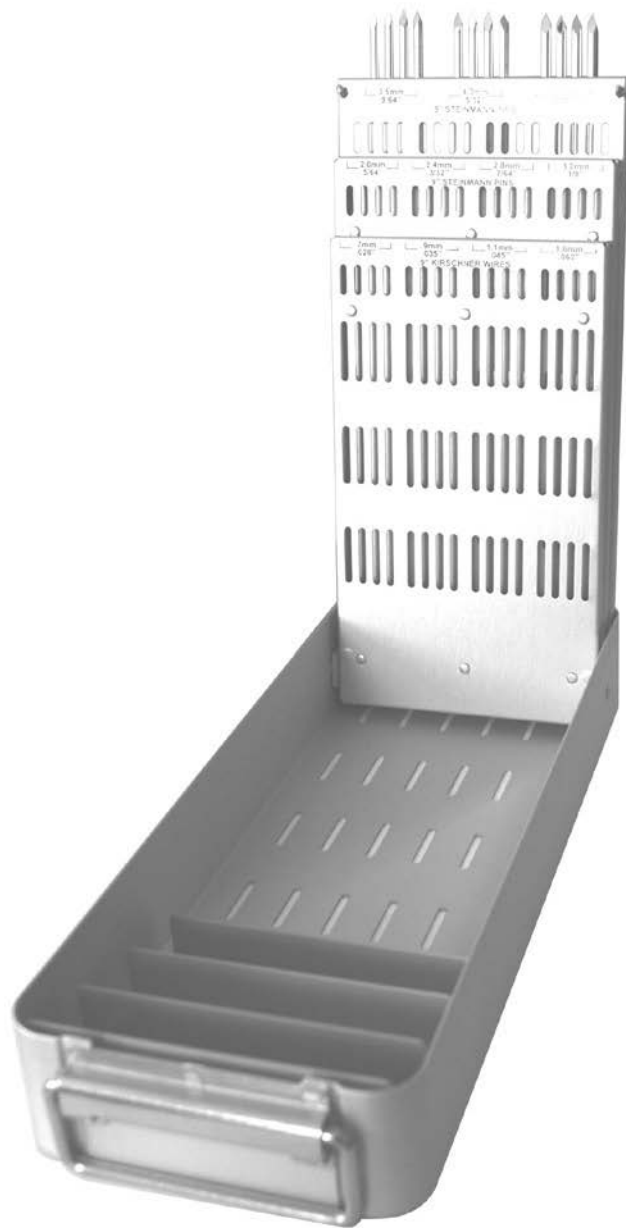

ORTHOMED K-WIRE AND STEINMANN PIN STERILIZATION CASE

OM 71-0009

13 5/8" x 5 1/4" x 2 1/4" (closed)

(346mm x 133mm x 57mm)

The OrthoMed, Inc. K-Wire and Steinmann Pin Sterilization Case holds popular 9" K-Wires and Steinmann Pins.

Accommodates four each of the following K-Wire diameters:

.028" (.7mm)
 .035" (.9mm)
 .045" (1.1mm)
 .062" (1.6mm)

Accommodates four each of the following Steinmann Pin diameters:

5/64" (2.0mm)
 3/32" (2.4mm)
 7/64" (2.8mm)
 1/8" (3.2mm)
 9/64" (3.5mm)
 5/32" (4.0mm)
 .177" (4.5mm)

- Removable lid fits under case – taking up less room in the O.R.
- Nylon coated brackets prevent metal-to-metal contact – protecting sharp ends.
- Contents are held in place when closed – preventing shifting.
- Secure locking side brackets help prevent accidental opening.
- Handles at each end for easy transport.
- Anodized aluminum case is lightweight and built to withstand abuse.
- Fully autoclavable to 270°F (132°C).

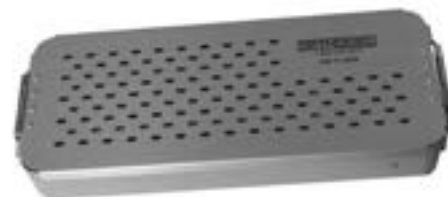

Case in closed position.

The OrthoMed, Inc. K-Wire sterilization container holds 4", 5", or 6" K-Wires.

Accommodates six each of the following K-Wire diameters:

.028" (.7mm)
.035" (.9mm)
.045" (1.1mm)
.054" (1.4mm)
.062" (1.6mm)

- K-Wire sizes are clearly noted on the inside of case for quick identification and reordering.
- Lid folds back and acts as a support to hold the case in an upright position – taking up less room in the O.R.
- Top of case locks when closed helping to prevent accidental opening.
- Case has a one piece design – eliminates the possibility of losing or switching case parts.
- Anodized aluminum case is lightweight and built to withstand abuse.
- Fully autoclavable to 270°F.



Designed to provide easy access and identification.

Case in open upright position

ORTHOMED K-WIRE STERILIZATION CONTAINER

OM 71-0008

6 1/4" x 4 1/8" x 3/4" (closed)
(158mm x 105mm x 19mm)



Case in closed position.



ORTHOMED K-WIRE AND STEINMANN PIN STERILIZATION CASE

OM 71-0011
13 5/8" x 5 1/4" x 2 1/4" (closed)
(346mm x 133mm x 57mm)

The OrthoMed, Inc. K-Wire and Steinmann Pin Sterilization Case holds popular 9" K-Wires and Steinmann Pins.

Accommodates twelve each of the following K-Wire diameters:

- .035" (.9mm)
- .045" (1.1mm)
- .062" (1.6mm)

Accommodates four each of the following Steinmann Pin diameters:

- 5/64" (2.0mm)
- 3/32" (2.4mm)

Accommodates two each of the following Steinmann Pin diameters:

- 7/64" (2.8mm)
- 1/8" (3.2mm)
- 9/64" (3.5mm)
- 5/32" (4.0mm)

- Removable lid fits under case – taking up less room in the O.R.
- Nylon coated brackets prevent metal-to-metal contact – protecting sharp ends.
- Contents are held in place when closed – preventing shifting.
- Secure locking side brackets help prevent accidental opening.
- Handles at each end for easy transport.
- Anodized aluminum case is lightweight and built to withstand abuse.
- Fully autoclavable to 270°F (132°C).



Case in closed position.



TKA BONE PIN WITH 3 FLUTES

OM 72-0300
3.2mm Diameter x 3½" (89mm) Length, Round End

OM 72-0305
3.2mm Diameter x 2 ½" (63mm) Length, Square End



TKA BONE PIN WITH FLUTES

OM 72-0315
3.2mm Diameter x 3" (76mm) Length, Square End



TKA BONE PIN WITH TROCAR TIP

OM 72-0330
3.2mm Diameter x 1¾" (45mm) Length, Tri End

TKA BONE PIN WITH TWO-FLUTES

OM 72-0335
3.2mm Diameter x 2¾" (70mm) Length, Tri End



TKA BONE PIN WITH TROCAR TIP

OM 72-0338
3.2mm Diameter x 2.63" (67mm) Length, Tri End



TKA BONE PIN WITH TROCAR TIP AND STOP

OM 72-0346
3.2mm Diameter x 2.63" (67mm) Length, Tri End



TKA BONE PIN

OM 72-0360
3.2mm Diameter x 3" (76mm) Length, Smooth, Round End



TKA BONE PIN WITH TROCAR TIP

OM 72-0366
3.2mm Diameter x 3" (76mm) Length, Smooth, Tri End

WIRE AND PIN MANAGEMENT



SECTION S



To store, autoclave, dispense, insert, hold, bend, pull, twist, cut, and tighten K-Wires, guidewires, Steinmann pins and rods.

CONTENTS

Wire Storage and Sterilization	1
Wire Drivers and Benders	2-4
Hand Drills	5-9
Wire and Pin Cutters	10-17
Rod Cutters	16-18
Cable Cutter	19
Plate Cutting Forceps	20
Pliers	20-24
Double Action Pliers	24
Locking Pliers	25-26
Locking Pliers with Slaphammers	27-28
Wire Tighteners and Twisters	29-31
Wire Guides and Tractors	32

ORTHO+MED
The Surgical Instrument Specialists

K-WIRE DISPENSER 6 1/4"

OM#	LENGTH	DIAMETER	QTY HELD
OM 72-0001	up to 6"	.028" (0.7mm)	100
OM 72-0002	up to 6"	.035" (0.9mm)	50
OM 72-0003	up to 6"	.045" (1.1mm)	40
OM 72-0004	up to 6"	.054" (1.4mm)	25
OM 72-0006	up to 6"	.062" (1.6mm)	20

Note:

- Stores, sterilizes, and dispenses one size at a time.
- Sharp points are protected by nylon cap.
- To avoid injury, load wire with blunt end down.
- Diameter is marked for easy identification.
- Perforation allows for proper sterilization.

K-WIRE DISPENSER 12 1/4"

OM#	LENGTH	DIAMETER	QTY HELD
OM 72-0012	up to 12"	.035" (0.9mm)	50
OM 72-0013	up to 12"	.045" (1.1mm)	40
OM 72-0014	up to 12"	.054" (1.4mm)	25
OM 72-0016	up to 12"	.062" (1.6mm)	20

For our selection of K-WIRES and pins see Section R.

STEINMANN PIN DISPENSER 12 1/4"

OM#	LENGTH	DIAMETER	QTY HELD
OM 72-0017	up to 12"	5/64" (2.0mm)	10
OM 72-0019	up to 12"	3/32" (2.4mm)	5



OM 71-0001 – OM 71-0006 for K-WIRE up to 6" long.



OM 71-0012 – OM 71-0019 for K-WIRE and pins up to 12" long.

VICKERS K-WIRE DISPENSER™

	LENGTH	CHAMBER #1		CHAMBER #2		CHAMBER #3		CHAMBER #4	
		DIAMETER	QTY HELD	DIAMETER	QTY HELD	DIAMETER	QTY HELD	DIAMETER	QTY HELD
OM 46-0542	4"	.028" (0.7mm)	36	.035" (0.7mm)	30	.045" (1.1mm)	24	.062" (1.6mm)	12
OM 46-0543	6"	.028" (0.7mm)	36	.035" (0.7mm)	30	.045" (1.1mm)	24	.062" (1.6mm)	12
OM 46-0538	12"	.028" (0.7mm)	36	.035" (0.7mm)	30	.045" (1.1mm)	24	.062" (1.6mm)	12
OM 46-0539	12"	.028" (0.7mm)	14	5/64" (2.0mm)	12	.086" (2.2mm)	8	3/32" (2.4mm)	6

* Note: For Steinmann Pins.

- Easily stores, sterilizes, and dispenses four different size wires.
- Dial on bottom allows for dispensing of one size at a time.
- To avoid injury, load wire with blunt end down.
- Dial can be locked to avoid accidental dispensing.
- Clearly marked chambers help avoid mix-up.

For our selection of K-Wires and pins see Section R.



OM 46-0542 for K-Wire up to 4" long.



OM 46-0539 and OM 46-0538 for 12" K-Wire.

WIRE, PIN DRIVERS AND BENDERS

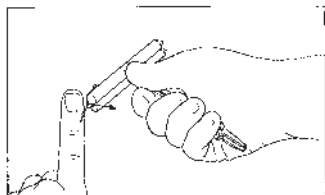
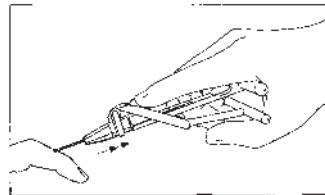
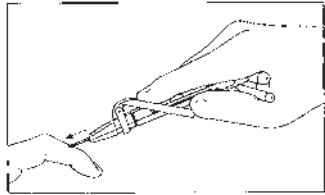

No Manual Device Has Ever Achieved This Function

For years, surgeons have sought a simple pin driver that could actually be fully controlled with one hand. The new Vickers Easidriver™ leaves the other hand free to manipulate tissue, leaving the patient in better hands.

Ideal Back Up Unit For Office and Hospital

What do you use when your power equipment fails during surgery? Now you have the handy Vickers Easidriver™. Without loss of precious time, it is ready for use. In cases where power equipment is not indicated or available, the Vickers can become your primary driver, allowing for feel and control that power units don't offer.

Dr. Vickers, who developed the patented instrument, is a specialist in hand surgery and the Chairman of the Instrumentation and Equipment Committee of the International Federation of Societies for Surgery of the Hand.

Now you can drive, bend and pull K-WIRE for a fraction of the cost of power equipment.

Note:

- Single handed operation
- Chuckless
- Depthscale
- Wire bending facility
- No maintenance
- No Set-Up
- Autoclavable
- For wire from .028" to .062"



VICKERS EASIDRIVER™

OM 46-0540
5 1/2"
German Stainless

No more lost keys! Keyless chuck for insertion and removal of Steinmann pins.

Cannulation accepts wires and pins up to .236 (6.0mm).

Chuck accepts wires and pins up to 1/4" (6.35mm).



OM 47-0903
4" (102mm)
fully cannulated

OM 47-0901
4 1/2" (114mm)
fully cannulated
with reverse lock

UNIVERSAL CHUCK WITH T-HANDLE

For insertion and removal of Steinmann Pins. Includes chuck key.

Cannulation accepts wires and pins up to .236 (6.0mm).

Chuck accepts wires and pins up to following 1/4" Steinmann pin chuck. (6.35mm).



OM 48-0374
4" (102mm)
fully cannulated

STEINMANN PIN CHUCK



Aids in bending
pins and wires

OM 48-0372
accepts wires & pins up to 1/8" (3.2mm)

WIRE & PIN BENDER

6" (152mm)



Use the pin chuck to insert intramedullary pins into the bone marrow cavity. Equipped with stainless steel Jacob's chuck and key which will accept 1/16" to 1/4" diameter pins. Fully cannulated handle with removable extension is made of aluminum for better balance and control.

OM 47-0896 Pin Chuck with Key
OM 47-0897 Key only

INTRAMEDULLARY PIN CHUCK

10" (254mm)



OM 49-0724
4 3/4" (121mm)
bends mini plates up to 1.1mm
(.045") K-Wire to 90° angle
3 prong

K-WIRE & PLATE BENDER



OM 49-0802
5 1/2" (140mm)
bends up to 1.6mm
(.062") K-Wire to 90° angle
3 prong

K-WIRE BENDER



OM 48-0269
6.1" (15.5cm)

WIRE BENDING PLIERS

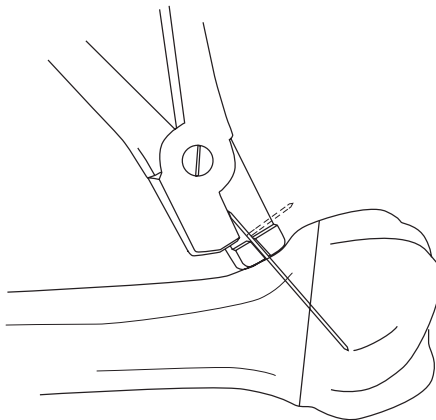

OM 48-0370
7 1/2" (191mm)
maximum capacity .062" (1.6mm)
special hardened, wear-resistant
stainless tool steel
U.S. patent #5,314,431

GRATLOCH™ WIRE BENDER

Bend .062" K-Wire single-handedly
without sacrificing stability.

Note:

The Gratloch Wire Bender can stabilize and bend a Kirschner wire simultaneously. K-Wires can be bent close to the bone singlehandedly without sacrificing fracture or osteotomy stability.

To bend wire:

1. After the insertion of K-Wire in the bone, cut the wire, leaving a piece of 1/2" to 3/4" in length.
2. Insert the K-Wire into angled slot of Gratloch™ Bender as close to the bone as possible.
3. Press handles to bend wire (.062" wire will bend 90°, smaller diameters will bend slightly less than 90°)
4. Additional features of the Gratloch™ Wire Bender include two angled cannulations at the proximal end of each handle for flush bending wire (.045" and .062").



OM 48-0392
 5 3/4" (146mm)
 cannulated
 3-jaw stainless Jacobs chuck
 includes key chuck
 accepts wires and pins up to 4mm
 (5/32")
 store chuck key in handle
 aluminum body
 key for Bunnell drill

Key only
 OM 48-0392P

BUNNELL DRILL

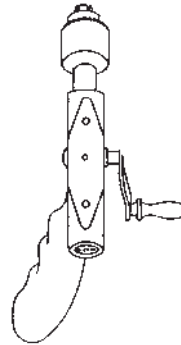

OM 48-0390
 6" (152mm)
 cannulated
 3-jaw stainless chuck
 includes key chuck
 accepts wires and pins up to
 6.35mm (1/4")
 offset handle
 aluminum body
 key for Ralks drill

Key only
 OM 48-0390P

RALKS DRILL

This hand drill has a two to one gear ratio to ensure accurate drilling. The comfortable pistol grip offset handle gives the user perfect control. The chuck shaft and the entire length of the drill are cannulated. The cannulated shaft accepts Steinmann pins, K-Wires, long shank drills, and screwdriver bits up to 4mm (5/32").

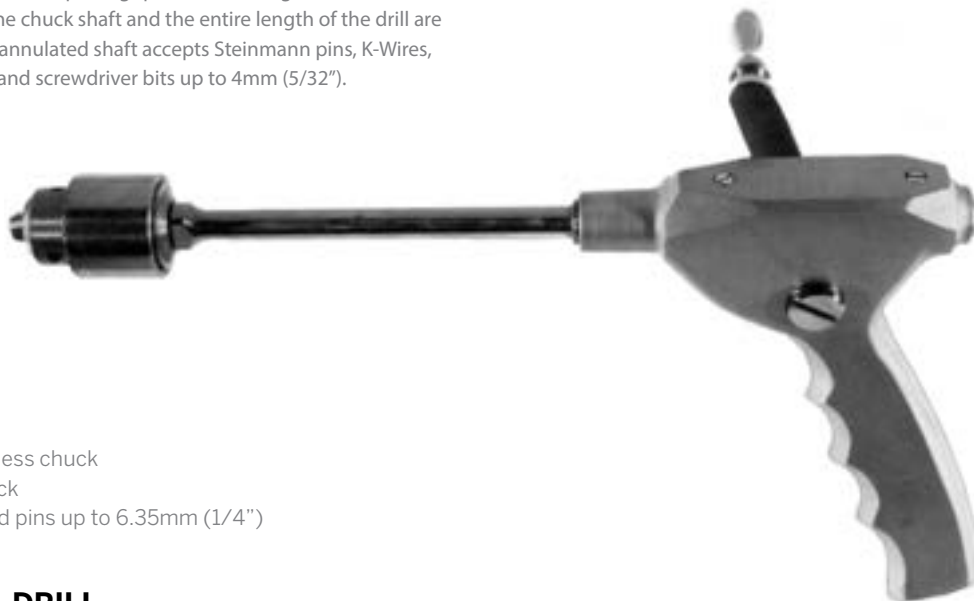

OM 48-0394
 10" (254mm)
 cannulated stainless chuck
 includes key chuck
 accepts wires and pins up to 6.35mm (1/4")
 aluminum body

UNIVERSAL DRILL



OM 48-0466
drill bit
2.5mm

OM 48-0467
drill bit
3mm

OM 48-0468
drill bit
3.5mm

OM 48-0465
9 1/2" (241mm)
drill only
chrome plated gears
stainless handle

OM 48-0469
drill and complete set of
stainless drill bits

STILLE-SHERMAN DRILL

With quick coupling



OM 48-0426
drill bit
2.5mm

OM 48-0427
drill bit
3mm

OM 48-0428
drill bit
3.5mm

OM 48-0429
drill bit
4mm

OM 48-0430
trephine
10mm

OM 48-0431
round burr
5mm

OM 48-0425
8" (203mm)
chrome plated drill only
chrome plated gears
stainless handle

OM 48-0438
drill and
complete set
of stainless
drill bits &
burrs

OM 48-0432
round burr
8mm

OM 48-0433
round burr
12mm

OM 48-0434
round burr
16mm

OM 48-0435
drill bit
1mm

OM 48-0436
drill bit
1.5mm

OM 48-0437
drill bit
2mm

STILLE PATTERN DRILL

With quick coupling



OM 48-0422
drill bit
9 cm length
3.2mm diameter

OM 48-0421
drill bit
7 cm length
3.2mm diameter

OM 48-0420
11" (279mm)
drill only
chrome plated drill
stainless handle

OM 48-0423
drill and complete set of
stainless drill bits

MOORE DRILL



OM 48-0415
10 1/2" (267mm)
stainless drill
anodized aluminum handle

MARTIN DRILL



CHUCK & KEY
OM 48-0443



COUPLING BOW
OM 48-0442



CHUCK & KEY
OM 48-0443



COUPLING BOW
OM 48-0442

DRILL GUIDE
OM 48-0441
shown extended

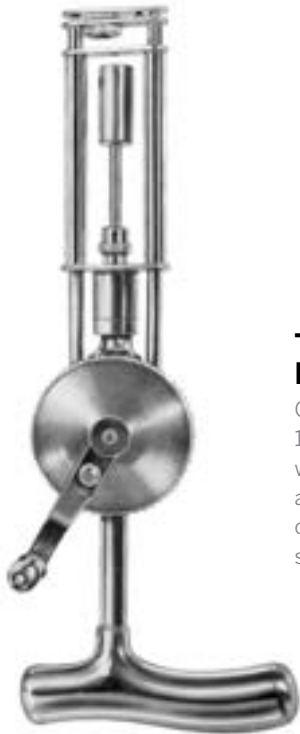

TELESCOPIC HAND DRILL
OM 48-0440
12" (305mm)
with drill guide, coupling bow
and chuck and key
chrome plated gears
stainless handle



DRILL GUIDE
OM 48-0451



KIRSCHNER DRILL
OM 48-0450
15" (381mm)
telescopic drill
with drill guide, coupling bow
and chuck and key
chrome plated gears
stainless handle



EXTENSION PIECE
OM 48-0455



HUDSON BURR
OM 48-0456
9mm



HUDSON BURR
OM 48-0457
14mm



HUDSON BURR
OM 48-0458
16mm



HUDSON BURR
OM 48-0459
22mm



HUDSON DRILL

OM 48-0454
10 1/2" (267mm)
drill only
with improved snap-lock chuck
all stainless handle

OM 48-0464
drill with extension piece and
complete set of stainless
burrs and bits



CUSHING DRILL BIT
OM 48-0460
14mm



DRILL BIT
OM 48-0461
2mm



MCKENZIE DRILL BIT
OM 48-0462
13mm



D'ERRICO DRILL BIT
OM 48-0463
16mm

ABOUT ORTHOMED WIRE AND PIN CUTTERS

In the past, surgeons have often had to rely on hardware store quality cutters made with inferior metals that can contaminate and ruin stainless steel instrumentation. Now OrthoMed can meet all of your wire and pin cutting requirements with our complete line of stainless steel cutting instruments.

Made From Stainless Steel – All of our wire cutters are engineered to meet the demanding needs of cutting rods, pins, cables and wires in the Operating Room. Jaws are made from the toughest specially-tempered tool steel or have tungsten carbide inserts.

More Cutting Power – Cutters designed with double action give you more cutting power and help absorb the shock of wire cutting. For the surgeon there is better control and less fatigue.

Most Extensive Selection – We offer more jaw and handle styles than any other instrument company.

Note on Carbide Instruments – Instruments with carbide inserts can be replaced, however, welded carbide jaws cannot be replaced.

To Achieve the Best Results When Cutting Wires and Pins, Follow these Simple Steps:

- Choose the appropriate cutter for the wire diameter you want to cut.
- Do not exceed the maximum capacity marked on each cutter.
- Cut wire in the middle of the jaw—not on the tip or in the corner.
- Keep the jaw at right angles to the piece being cut. Do not twist or turn cutter.

Caution: Be sure to protect patient and O.R. personnel from flying particles (especially the eyes). The harder the metal, the farther the pieces can fly.

IMPORTANT NOTE ON MAXIMUM CAPACITIES

Modern rods and pins vary greatly in hardness and tensile strength. All maximum capacities noted are based on tests using standard strength implant material. Cutting material which exceeds our standard strength ratings, such as certain high strength spinal rods, may damage or shorten the life of cutting edges and voids the instrument warranty. If you're not sure whether our cutter can handle your material, give us a call at (800) 547-5571.

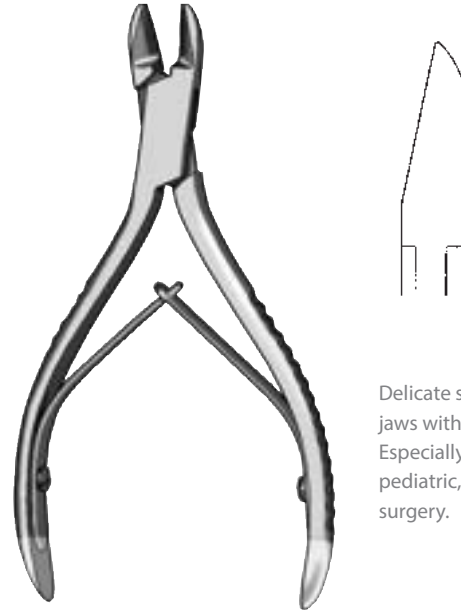

Delicate side-cutting jaws with carbide inserts. Especially useful for pediatric, foot and hand surgery.

DELICATE WIRE CUTTER

OM 46-0622
4 3/4" (121mm)
side cutting
with carbide inserts
maximum capacity .028" (0.7mm)

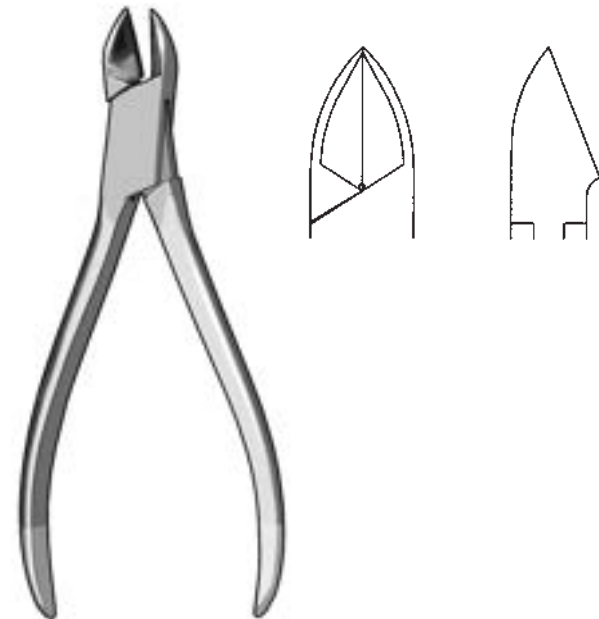

K-WIRE SIDE CUTTER

OM 49-0734
6" (152mm)
side cutting
welded carbide jaws
maximum capacity .045" (1.1mm)

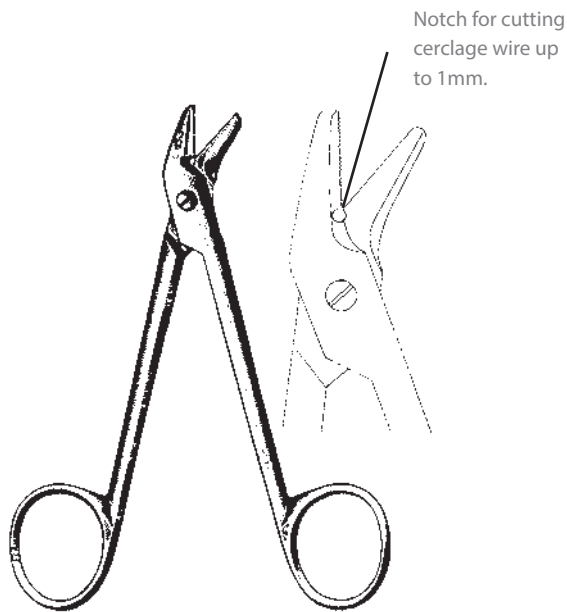

WIRE CUTTING SCISSORS

4 3/4" (121mm)

OM 35-0198

one serrated blade
angular

OM 35-0200

one serrated blade
angular, carbide

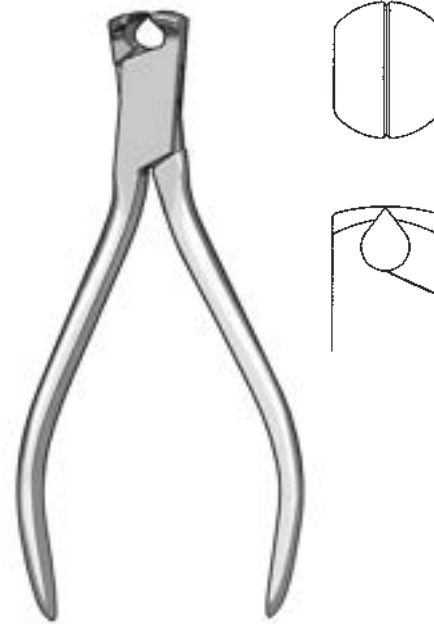

K-WIRE END CUTTER

OM 49-0735

5 1/2" (140mm)

end cutting
maximum capacity .045" (1.1mm)



Disassembles easily
for cleaning.

DIAMOND PIN CUTTER

OM 46-0651

6 1/4" (159mm)

end cutting
maximum capacity 5/64" (2.0mm)



END CUTTER

OM 46-0649

6" (152mm)

end cutting
welded carbide jaws
maximum capacity
.062" (1.6mm)

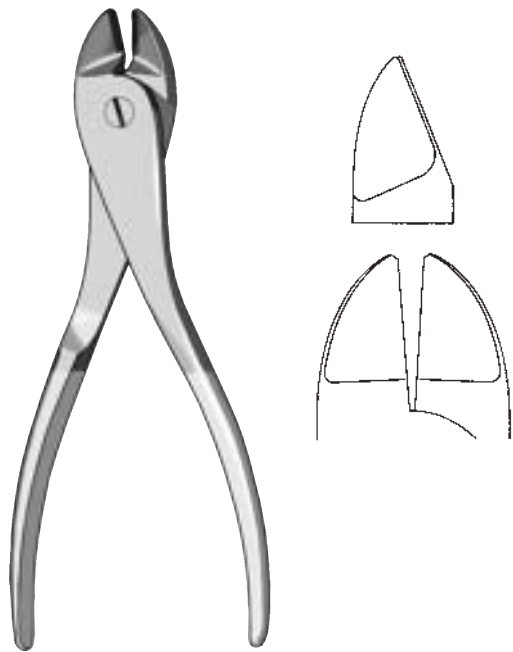

SIDE CUTTER

OM 46-0621
 7" (178mm)
 side cutting
 welded carbide jaws
 maximum capacity .062" (1.6mm)

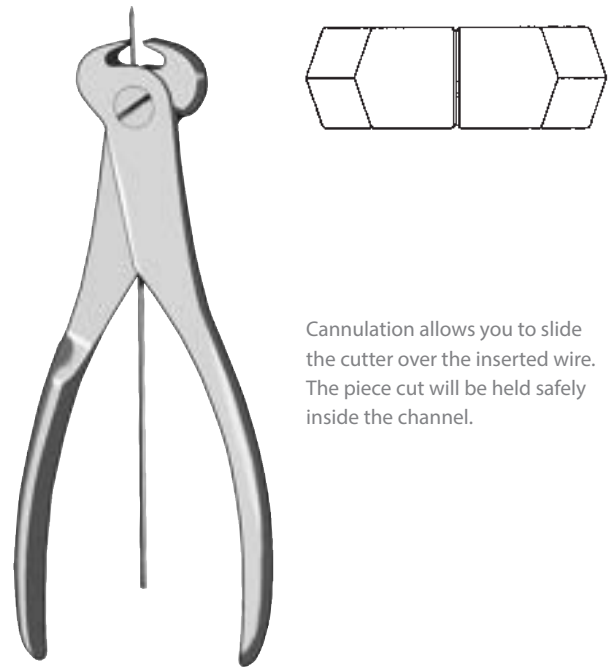

Cannulation allows you to slide the cutter over the inserted wire. The piece cut will be held safely inside the channel.

CANNULATED PIN CUTTER

OM 46-0647
 7 1/2" (191mm)
 end cutting
 maximum capacity .062" (1.6mm)

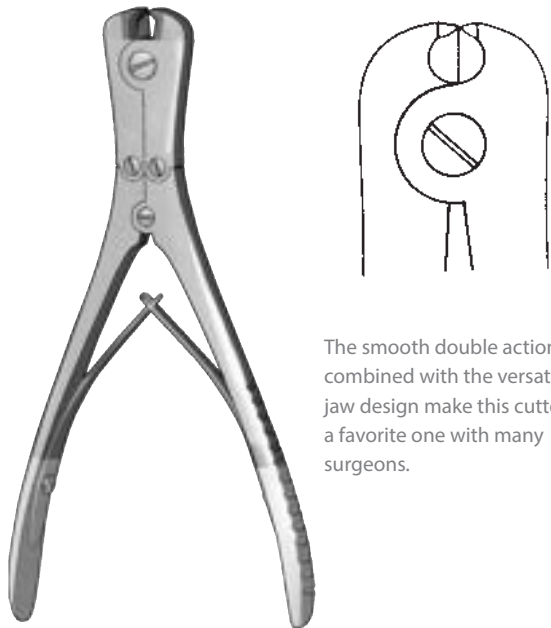

The smooth double action combined with the versatile jaw design make this cutter a favorite one with many surgeons.

FRONT AND SIDE WIRE CUTTER

OM 46-0625
 7" (178mm)
 front and side cutting
 with carbide inserts, double action
 maximum capacity .062" (1.6mm)

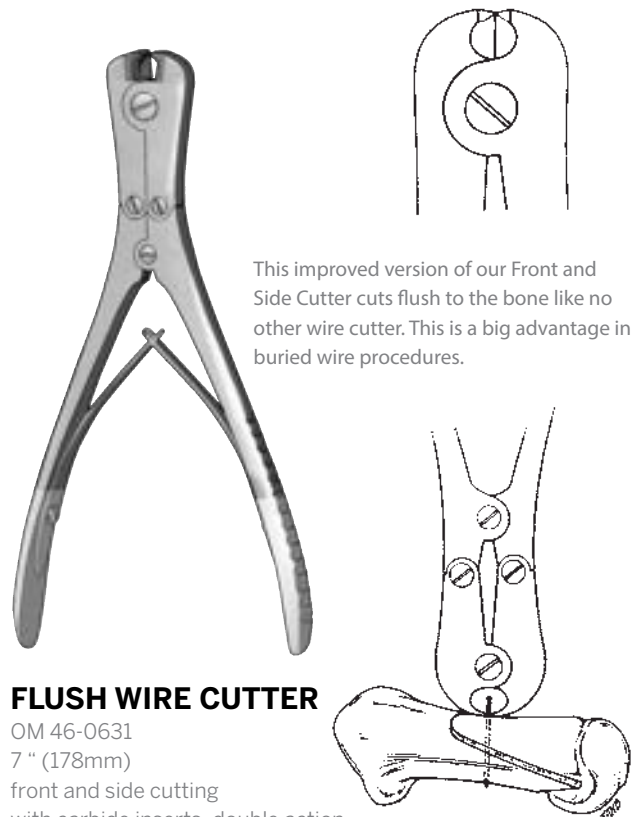

This improved version of our Front and Side Cutter cuts flush to the bone like no other wire cutter. This is a big advantage in buried wire procedures.

FLUSH WIRE CUTTER

OM 46-0631
 7" (178mm)
 front and side cutting
 with carbide inserts, double action
 maximum capacity .062" (1.6mm)

Note: The OrthoMed Wire Cutter with Safety Inserts can help prevent the potentially dangerous occurrence of flying K-Wire pieces in the O.R. This instrument is designed to hold the cut piece of wire in its silicone inserts. After cutting, the remnant wire can be safely disposed of, thus preventing cut pieces from falling into the wound site or flying into the air. The silicone inserts are autoclavable and long lasting. As inserts are not glued into the jaws, replacement is fast and easy. Simply insert the new ones by pressing them into place. Inserts do not fall out or move under normal circumstances.

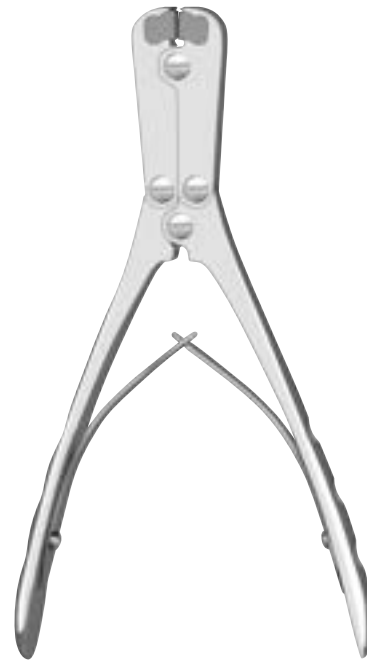
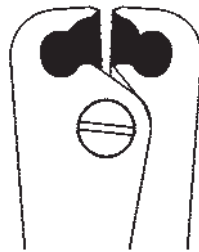

OM 49-0740
7" (178mm) front and side cutting
double action
maximum capacity .062" (1.6mm)
patent pending

OM 49-0740P
set of replacement
silicone inserts

WIRE CUTTER

With safety inserts
Combines maximum leverage and optimum safety.

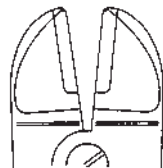
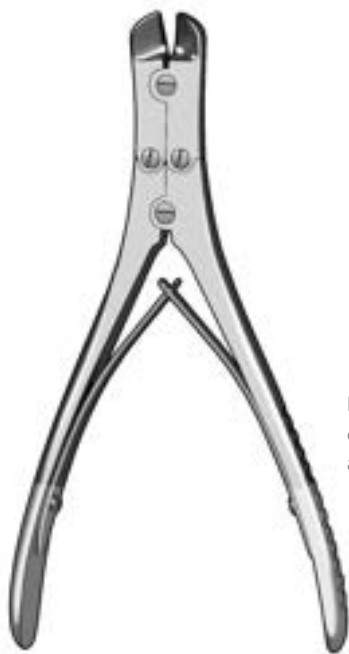

Narrow jaw makes this cutter a favorite with hand and foot surgeons.

DOUBLE ACTION WIRE CUTTER

OM 46-0623
7" (178mm)
angled, side cutting
with carbide inserts
maximum capacity .062" (1.6mm)

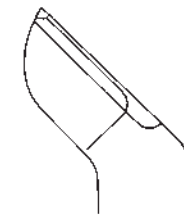
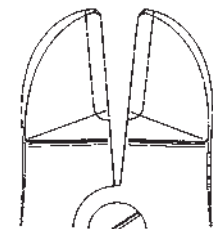

DOUBLE ACTION WIRE CUTTER

OM 46-0624
8 1/2" (216mm)
angled, side cutting
with carbide inserts
maximum capacity 3/32" (2.4mm)



Over 40% less power required for pins and K-Wire of max. 2.2mm (3/32") exchangeable TC blades, exchangeable rubber jaws.

HERCULES WIRE CUTTER

OM 85-0100
7" (178mm)



Over 40% less power required for K-Wire of max. 1.6mm (.062") exchangeable TC blades with integrated rubber jaws.

HERCULES FRONT AND SIDE CUTTER

OM 85-0105
7" (178mm)

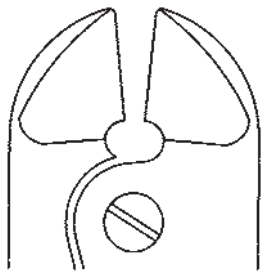

SIDE CUTTER

OM 49-0736
9" (229mm)
side cutting
welded carbide jaws
maximum capacity 3/32" (2.4mm)

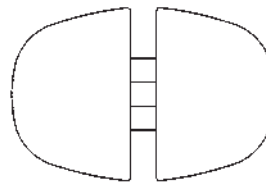

END CUTTER

OM 49-0738
8 1/2" (216mm)
end cutting
welded carbide jaws
maximum capacity 3/32" (2.4mm)

OM 85-0107
9" (230mm)
Maximum cutting capacity - 3mm wire



Over 40% less power required for pins and K-Wires. Exchangeable TC blades and rubber jaws.

GOLD CUT HERCULES WIRE CUTTER

OM 85-0110
11" (280mm)
Maximum cutting capacity - 3.5mm wire



Over 40% less power required for pins and K-Wires. Exchangeable TC blades and rubber jaws.

GOLD CUT HERCULES WIRE CUTTER

WIRE AND PIN CUTTERS

The Orthomed Rod cutter cuts 4.5mm (.177"), 5.5mm (.217"), and 6.35mm (1/4") pins and rods. It will cut clean leaving a smooth surface without sharp edges or burrs. Available with and without detachable handles. Double action makes cutting easier.

ROD CUTTER

OM 60-0180

22" (559mm)

with detachable handles and silicone handle



BASE PLATE FOR ROD CUTTER

OM 60-0185

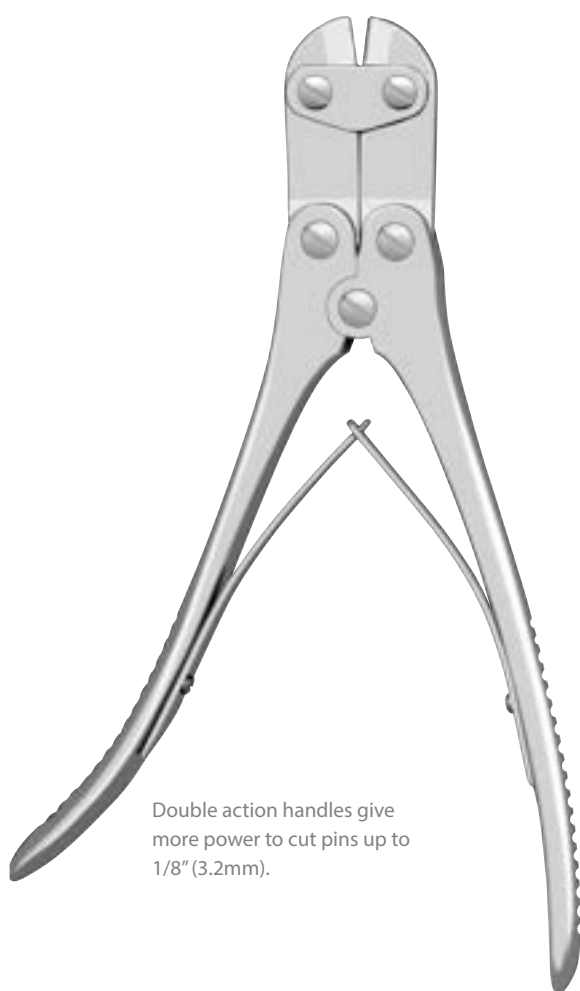
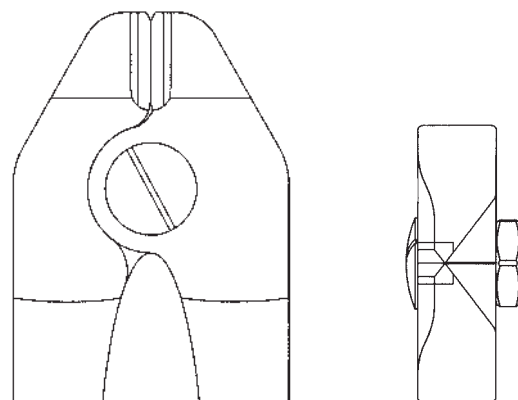
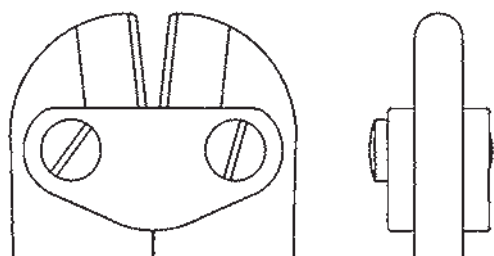

Double action handles give more power to cut pins up to 1/8" (3.2mm).

DOUBLE ACTION PIN CUTTER

OM 49-0800
 9 1/2" (241mm)
 side cutting
 maximum capacity 1/8" (3.2mm)

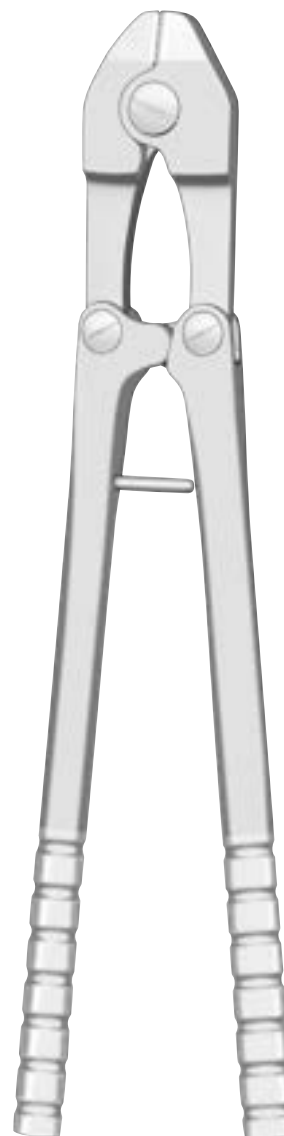

Heavy duty cutter for rods up to 4.0mm and heavy Steinmann pins.

Slightly angled jaws house long-lasting special carbide inserts for cutting hard titanium and stainless steel rods.

SIDE PIN CUTTER

OM 46-0629
 15" (381mm)
 side cutting
 with carbide inserts
 maximum capacity 5/32 " (4.0mm)

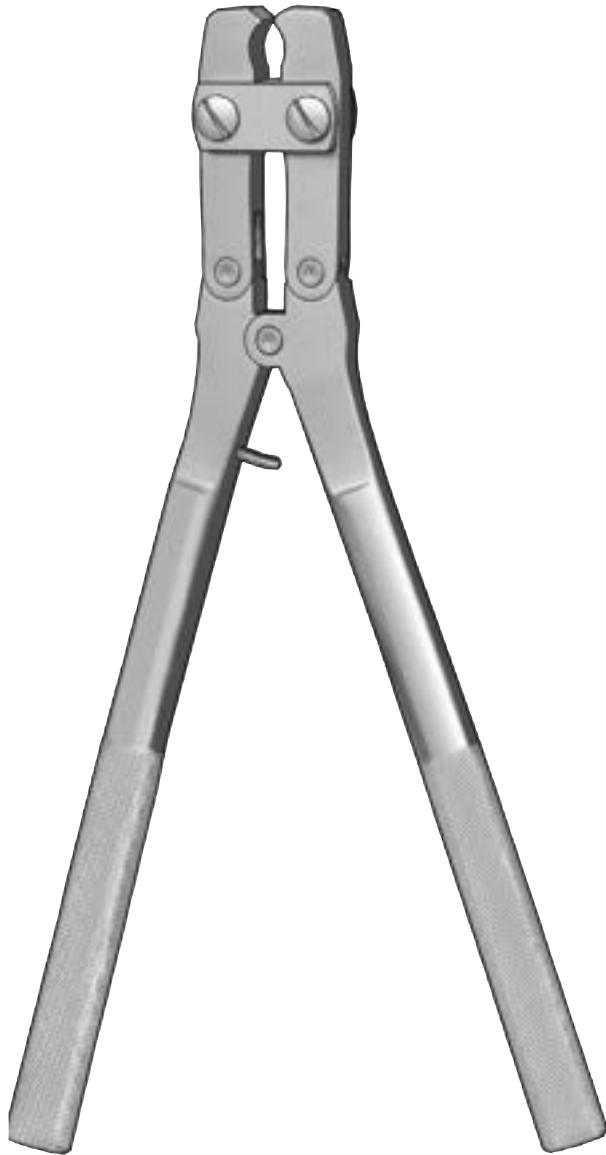
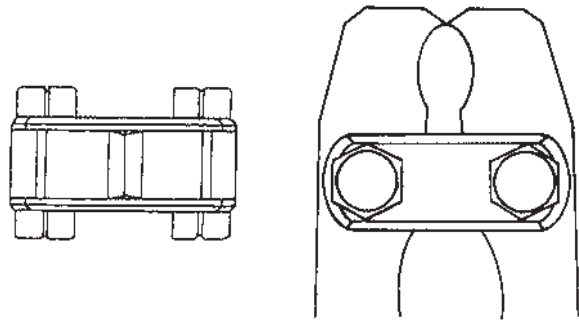

PIN CUTTER (SMALL)

OM 46-0632
10" (254mm)
end cutting
maximum capacity 1/8" (3.2mm)

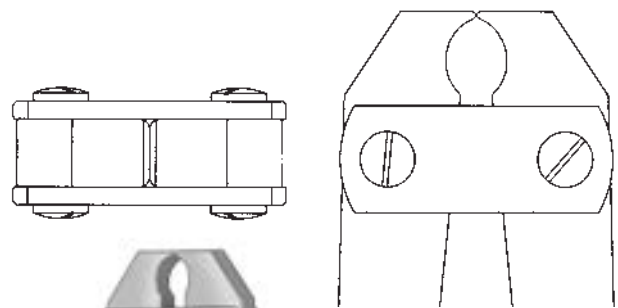

Heavy duty cutters have replaceable jaws.

PIN CUTTER (MEDIUM)

OM 46-0633
16" (406mm)
end cutting
maximum capacity 3/16" (4.7mm)

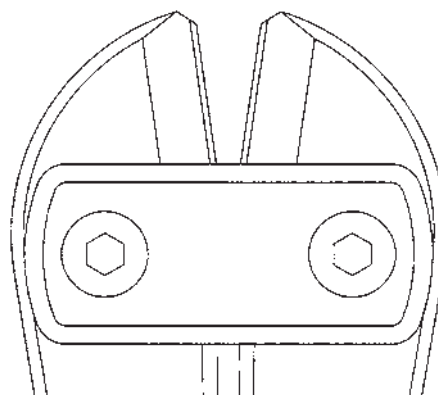
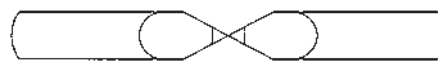

Precisely ground jaws are made from the hardest stainless steel available. This cutter will cut harder spinal rods for a longer period of time.

Please see our note about maximum capacities on page S10.

Important:
This large cutter is not designed to be used inside the patient's body.

PIN CUTTER (LARGE)

OM 46-0626
22" (559mm)
side cutting
maximum capacity 1/4" (6.3mm)
patent pending



TABLE TOP ROD CUTTER

Provides an easy and safe way to cut spinal rods.

OM 46-0628

27" (689mm)

stainless steel with silicone handle

How to use:

1. Lift handle up.
2. Insert rod in proper diameter hole.
3. Press handle down.

Powerful double-action jaw enables surgeons to cut 1/4" rods with one hand.

Shearing action cuts cleanly – no raised burrs or sharp jagged edges.

Unique cutting process can help prevent the potentially dangerous occurrence of flying rod pieces in the O.R.

Ergonomically designed patented Ortho-Grip™ silicone handle provides a comfortable, slip-proof grip.

Base and handle are perfectly balanced to ensure stability and prevent lifting.

Simple efficient design has no folding levers, loose parts, or bearings that can break down.

Cuts rods from:

4.76mm (3/16") to 6.35mm (1/4").



All the benefits of a table top cutter in a hand-held model.

Cuts rods from:

4.76mm (3/16") to 6.35mm (1/4")

HAND-HELD ROD CUTTER

OM 46-0635

27" (686mm)

stainless steel with silicone handle

Important:

This large cutter is not designed to be used inside the patient's body.

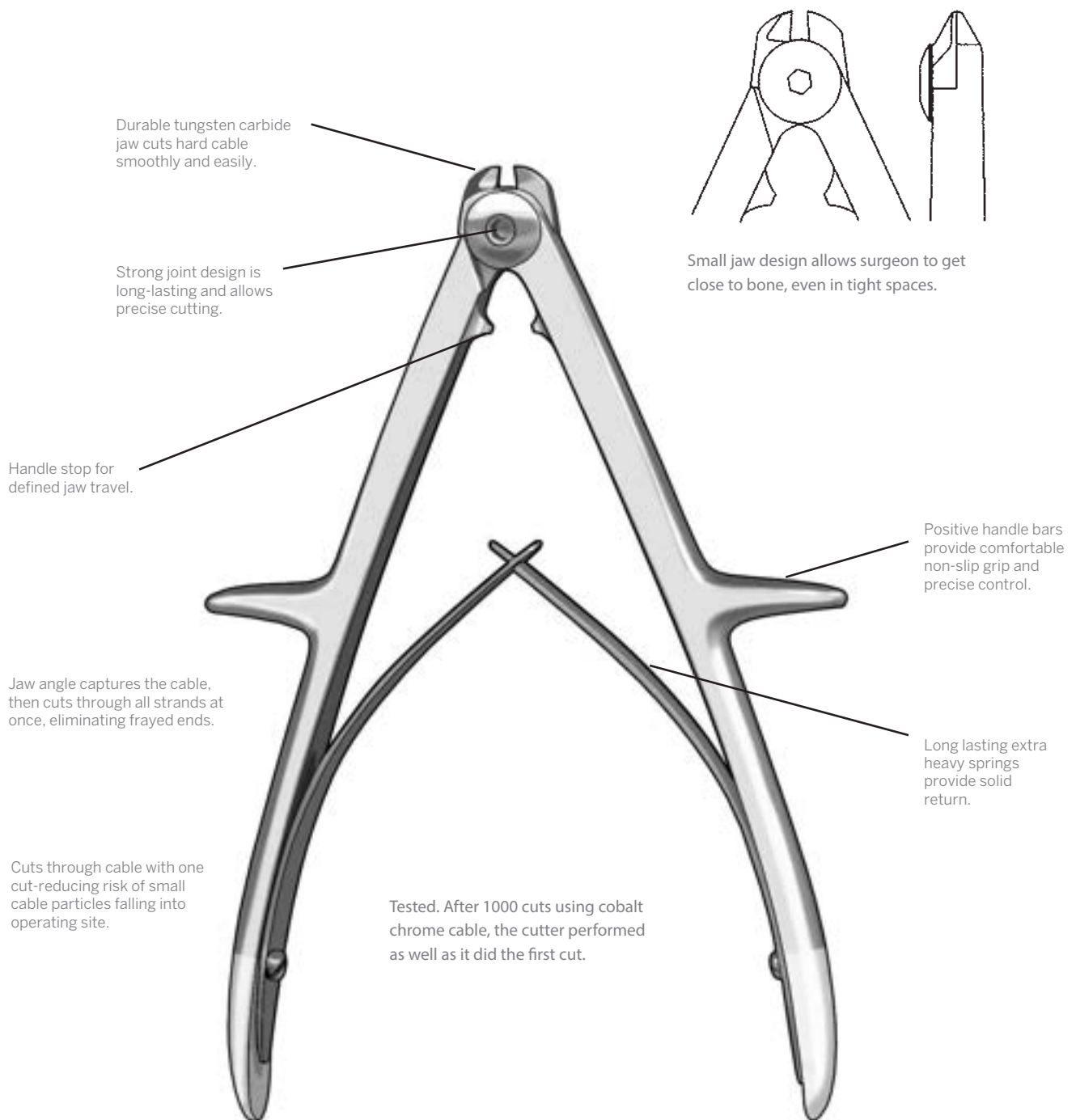

CABLE CUTTER

Cuts cleanly through cables without fraying!
 OM 48-0378
 7" (178mm)
 maximum capacity 2.0 mm
 cable jaws can be resharpened and replaced

Note: This instrument should only be used for cutting cable. Lubricate joint to ensure proper function.

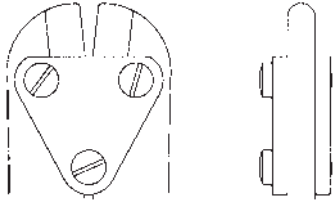

PLATE CUTTING FORCEPS

OM 47-0932
9 1/2" (241mm)
for cutting stainless steel
mini plates up to 1mm

Universal pin extractor
includes a striking pad for pin
insertion. Ergonomic handle
for positive grip.



PIN PULLER

OM 47-0890 2.8mm to 3.2mm pins

ABOUT ORTHOMED PLIERS

We manufacture a wide range of stainless steel pliers. Whether you are bending delicate 0.2mm cerclage wire or removing a 3.2mm Steinmann Pin, we make a pair of pliers to handle the job.

QUALITY ASSURANCE

Every OrthoMed instrument is made for us to exact specifications. Much of our time is spent assuring the quality of the products we sell. The OrthoMed name does not go on any instrument that fails to pass our tough Quality Assurance Standards. We know our reputation depends on providing a quality product that will perform consistently for years.

VALUE

They are built to last! Our instruments are made from the finest German stainless steel. Unlike inferior "hardware store" quality, our pliers won't chip or contaminate fine surgical instruments.

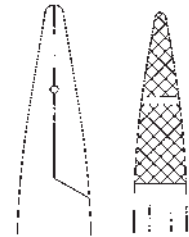

Delicate needle nose jaws specifically
designed to handle cerclage wire.
Jaw tapers to 1mm.

NEEDLE NOSE PLIERS

OM 48-0242
5 1/2" (140mm)
delicate

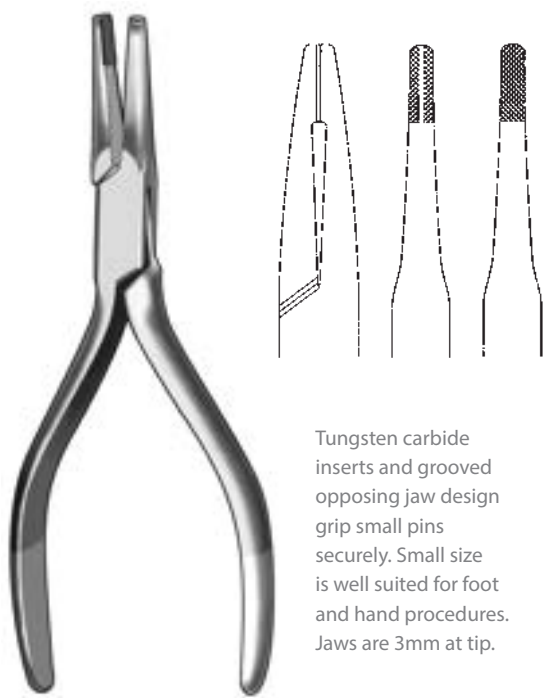

Tungsten carbide inserts and grooved opposing jaw design grip small pins securely. Small size is well suited for foot and hand procedures. Jaws are 3mm at tip.

PIN PULLING PLIERS

OM 46-0578
5 1/2" (140mm)
with tungsten carbide inserts
3mm tip

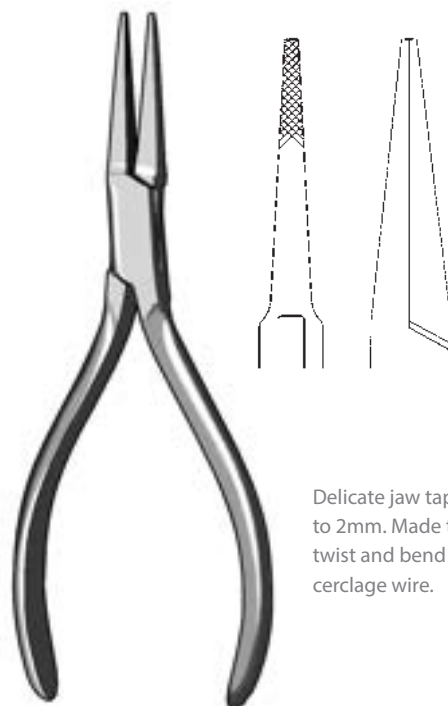

Delicate jaw tapers to 2mm. Made to twist and bend cerclage wire.

FLAT NOSE PLIERS

OM 48-0248
6" (152mm)
delicate
2mm tip

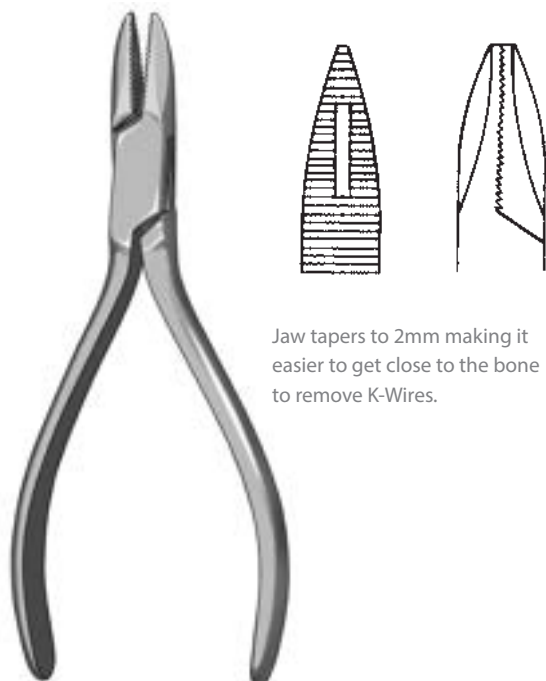

Jaw tapers to 2mm making it easier to get close to the bone to remove K-Wires.

NEEDLE NOSE PLIERS

OM 48-0245
5 1/2" (140mm)
2mm tip

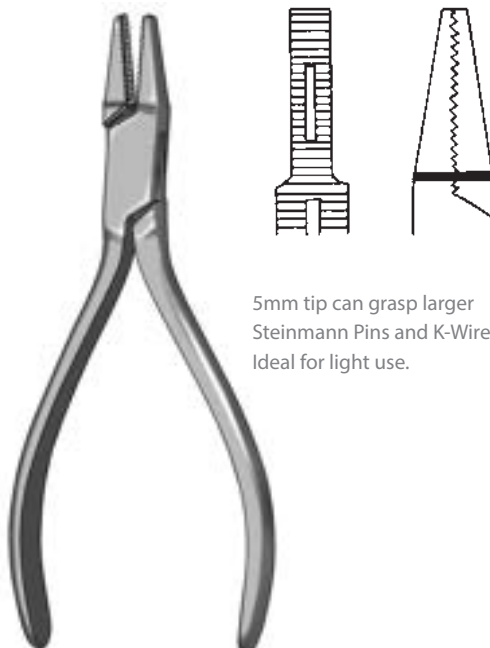

5mm tip can grasp larger Steinmann Pins and K-Wires. Ideal for light use.

FLAT NOSE PLIERS

OM 48-0246
5 1/2" (140mm)
broad
5mm tip

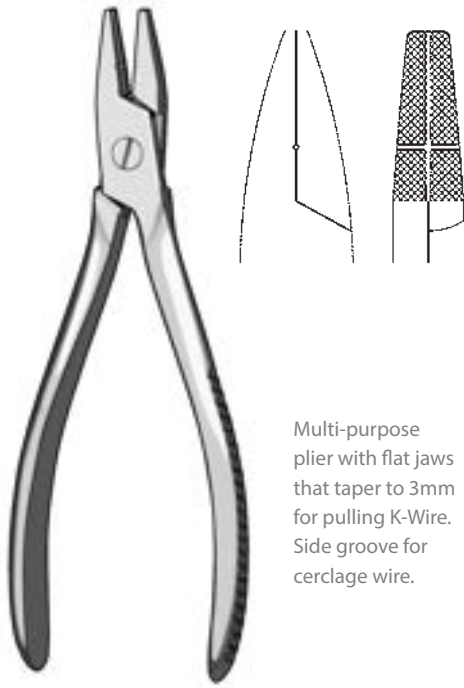

Multi-purpose plier with flat jaws that taper to 3mm for pulling K-Wire. Side groove for cerclage wire.

FLAT NOSE K-WIRE PLIERS

With groove
OM 48-0254
7" (178mm)
3mm tip

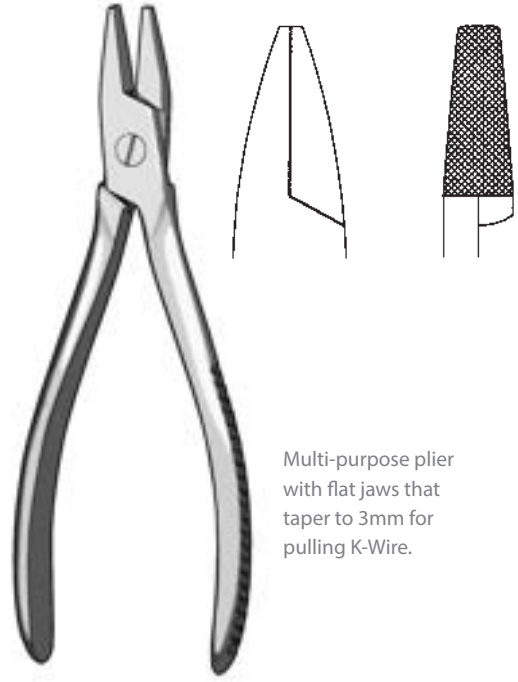

Multi-purpose plier with flat jaws that taper to 3mm for pulling K-Wire.

FLAT NOSE K-WIRE PLIERS

OM 48-0256
7" (178mm)
3mm tip

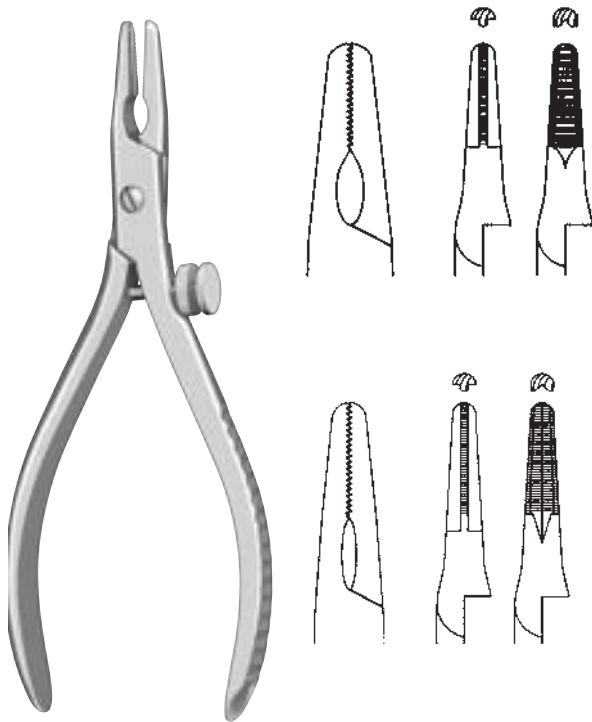

K-WIRE EXTRACTION PLIERS

With screw lock
OM 48-0257 5" (127mm) 3mm tip
OM 48-0258 7" (178mm) 4mm tip

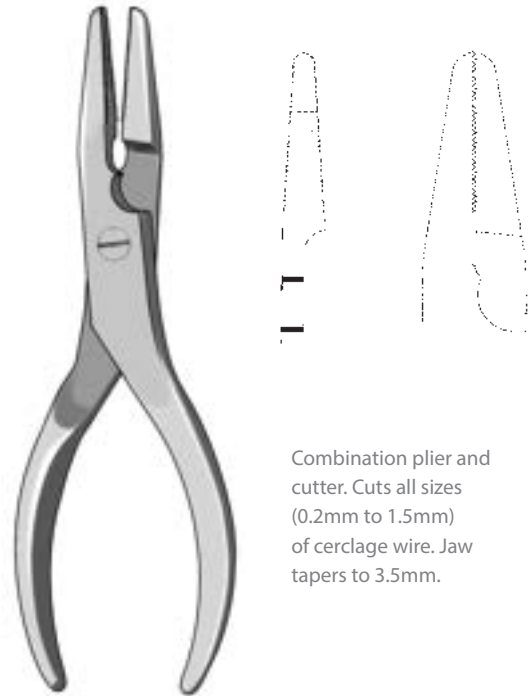

Combination plier and cutter. Cuts all sizes (0.2mm to 1.5mm) of cerclage wire. Jaw tapers to 3.5mm.

FLAT NOSE PLIERS

OM 48-0243
6 1/2" (165mm)
3.5mm tip

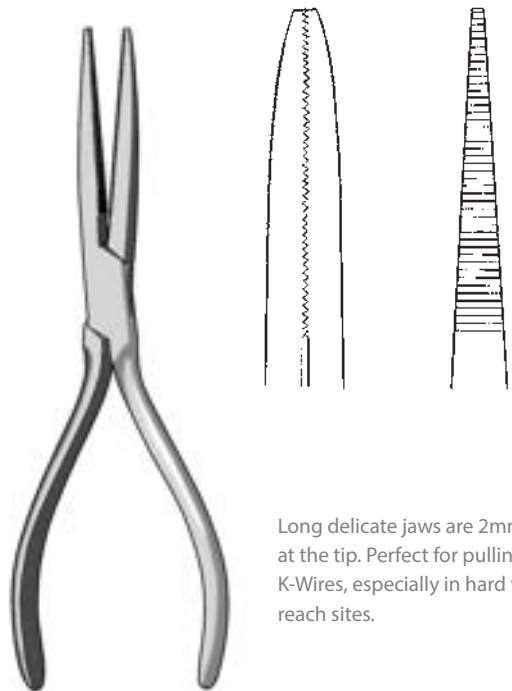

Long delicate jaws are 2mm at the tip. Perfect for pulling K-Wires, especially in hard to reach sites.

LONG JAW NEEDLE NOSE PLIERS

OM 48-0250
7" (178mm) parallel grooved jaws
jaw length: 2 1/4"
2mm tip

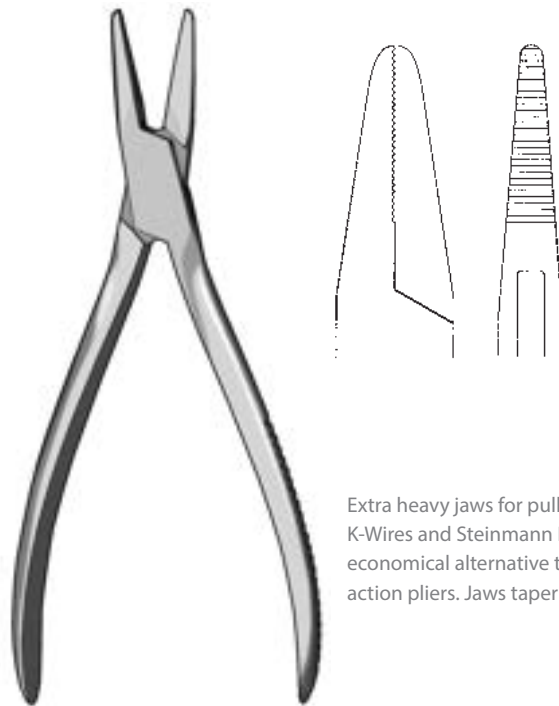

Extra heavy jaws for pulling K-Wires and Steinmann Pins. An economical alternative to double action pliers. Jaws taper to 3mm.

NARROW NOSE WIRE PULLING FORCEPS

OM 48-0253
7 1/2" (191mm)
3mm tip



Useful for removing 3.0mm to 4.5mm screws.

SCREW REMOVAL FORCEPS

With speed lock
OM 49-0920
7" (178mm)
with carbide inserts

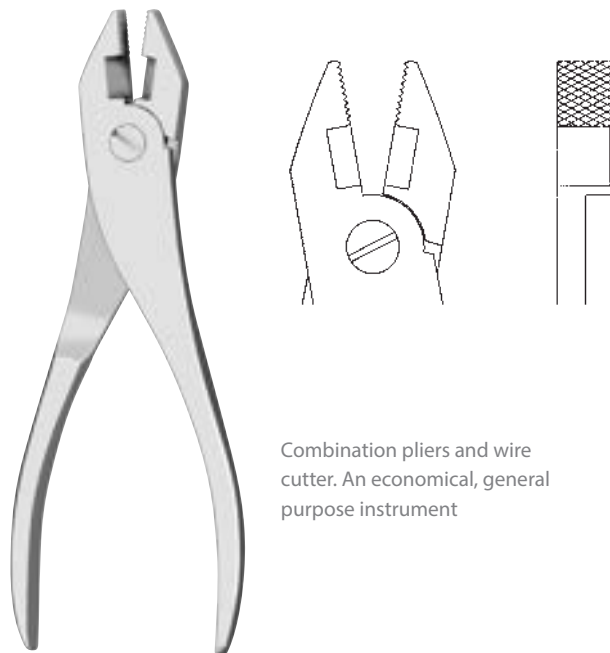

Combination pliers and wire cutter. An economical, general purpose instrument

LINEMAN PLIERS

With cutting edge
OM 48-0259
8 1/2" (216mm)
side cutting
maximum capacity .062" (1.6mm)

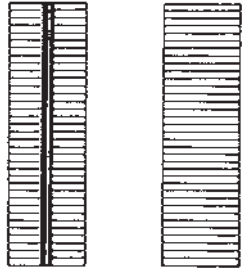

Parallel grooved 10mm jaws provide enormous gripping power. Ideal for pin removal.



PARALLEL PLIERS

OM 48-0604
7" (178mm)
10mm tip
maximum opening 1/2"

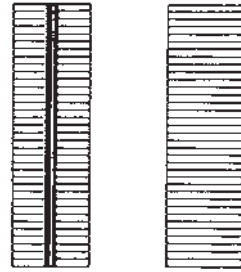

Combination pliers and wire cutter has all the benefits of our Parallel Pliers plus a cutting jaw for K-Wires up to .062" (1.6mm).

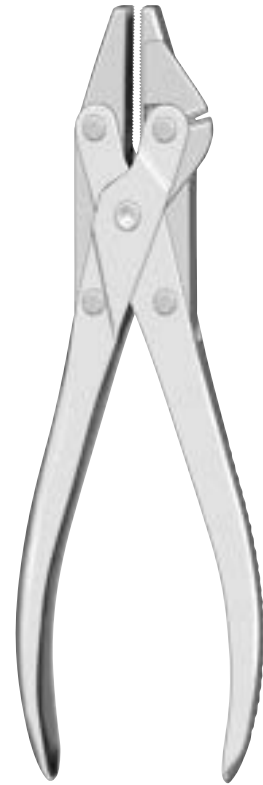

PARALLEL PLIERS

With cutter
OM 48-0605
7" (178mm)
10mm tip
maximum opening 1/2"
maximum capacity .062" (1.6mm)



Traditional design utility pliers have adjustable jaws. Good all purpose plier for handling Steinmann Pins, K-Wires, screws, and rods. 10mm jaw tip.

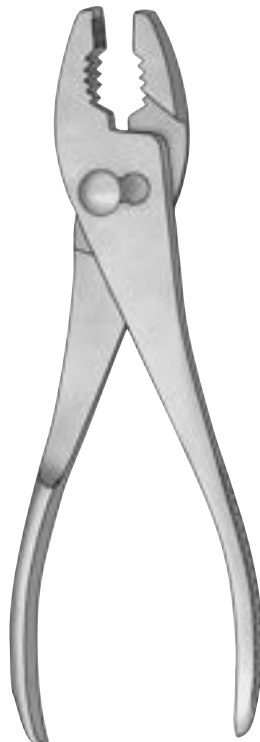

SLIP JOINT PLIERS

OM 48-0262
8" (203mm)
10mm tip
maximum opening 2"

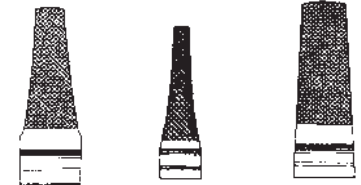

Recommended for heavy use. Double action and finely serrated carbide tips combine to provide a powerful grip on K-Wires and pins.

2mm tip is ideal for removing K-Wire up to .62mm from small, hard-to-reach sites.

4mm to 6mm jaws are ideal for grasping and pulling all sizes of K-Wires and pins.

DOUBLE ACTION WIRE EXTRACTION PLIERS

OM 46-0572 7" (178mm) 2mm delicate jaw, carbide
OM 46-0573 7" (178mm) 4mm jaw, carbide
OM 46-0574 7" (178mm) 6mm jaw, carbide



OM 15-0355

T-HANDLE TORQUE LIMITER

10mm 6" 5 1/2" (140mm)



TORQUE LIMITER



Full line of silicone T or Straight (in-line) handles in a variety of sizes. Standard or custom colors. AO, Hudson, 1/4", or custom couplings available. Ratcheting, non-ratcheting, and torque limiting option which include a 3 year or 6000 click recalibration guarantee. For details on this complete line, call 1-800-547-5571, or e-mail specific handle configuration requirements to custserv@orthomedinc.com

SILICONE T-HANDLE



OM 14-0455A

BLACK SILICONE T-HANDLE RATCHET

4.8" (123MM)



ROD HOLDER

OM 49-0708
5.5mm rods 7 1/4" Str.



ROD HOLDER FOR RODS

OM 60-0230
6.0-6.35mm



ROD HOLDER

OM 60-0220 11" (279mm)
For 5.5mm rods

HEAVY DUTY LOCKING PLIERS
WITH A NEW REINFORCED, MORE DURABLE JAW

- Heavy duty jaws lock securely onto pins
- Reinforced jaw hinge and housing are more rigid to help prevent side to side shifting
- Made from 300 and 400 series surgical grade stainless steel
- Will not chip or contaminate other instrumentation
- Adjustment screw for easy control of jaw opening
- One-handed, quick release self locking lever
- Available in three sizes

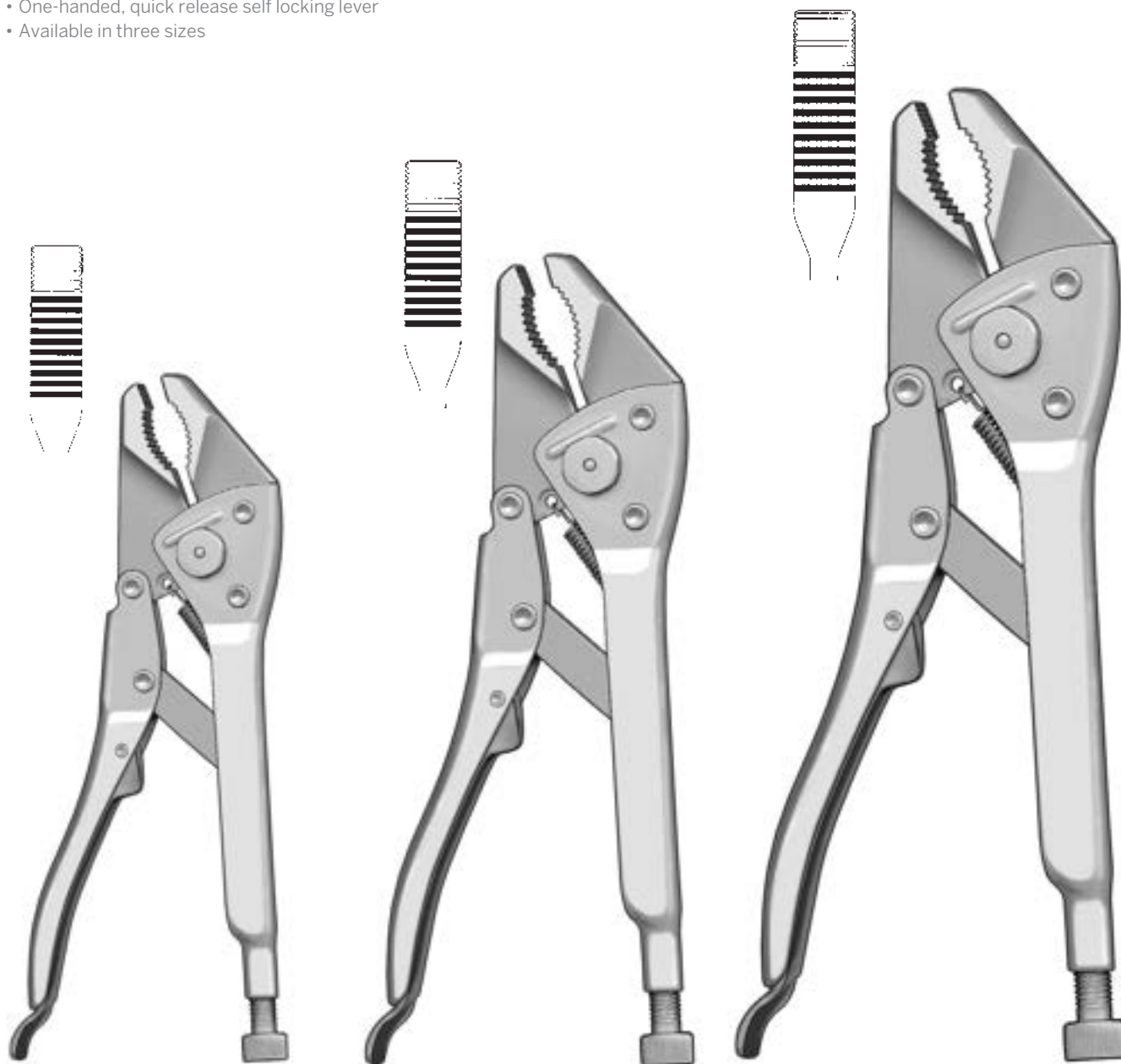

SMALL LOCKING PLIERS

OM 48-0600
6 3/4" (171mm)
tip width 7mm
maximum opening 1"

MEDIUM LOCKING PLIERS

OM 48-0602
8" (203mm)
tip width 9mm
maximum opening 1"

LARGE LOCKING PLIERS

OM 48-0608
10" (254mm)
tip width 13mm
maximum opening 1 1/2"

LOCKING PLIERS

NEEDLE NOSE LOCKING PLIERS WITH A NEW REINFORCED, MORE DURABLE JAW.

- New 12" model has an impressive powerful jaw. The body is made from 2.5mm stainless steel. This plier will hold up better in the O.R. than any other needle nose plier – we guarantee it!
- Both pliers have a more durable reinforced jaw hinge and housing which helps keep the ends in alignment, especially when plier is twisted.
- Other features; one tapered "V" grooved jaw which locks securely onto pins; adjustment screw; and one handed, quick release self-locking lever.
- OrthoMed pliers are made from 300 and 400 series surgical grade stainless steel. Unlike "hardware store" quality, they will not chip or contaminate other instrumentation.



NEEDLE NOSE LOCKING PLIERS

OM 48-0606
9 1/2" (241mm)
length of jaw 2 1/2"
tip width 5mm
jaws are parallel at 3mm



LARGE NEEDLE NOSE LOCKING PLIERS

OM 48-0610
12" (305mm)
length of jaw 3"
tip width 7mm
jaws are parallel at 5mm

LOCKING PLIERS WITH SLAPHAMMERS

- Implants are removed more effectively with well-engineered slaphammer attachments
- Force is applied directly in line with jaws – providing more control during implant removal
- Stable three point contact – reduces the possibility of twisting or turning
- Interchangeable – one slaphammer can be used with two different pliers
- German stainless steel



LOCKING PLIERS

Standard

- | | |
|------------|---|
| OM 48-0630 | 7" (178mm) small for 400gr slaphammer |
| OM 48-0631 | 8" (203mm) medium for 400gr slaphammer |
| OM 48-0632 | 9 1/2" (235mm) large for 700gr slaphammer |

Needle Nose

- | | |
|------------|---|
| OM 48-0633 | 8 1/2" (216mm) small for 400gr slaphammer |
| OM 48-0634 | 10" (254mm) medium for 400gr slaphammer |
| OM 48-0635 | 12" (305mm) large for 700gr slaphammer |

SLAPHAMMER

- | | |
|------------|--|
| OM 48-0625 | 400gr slaphammer for small & medium pliers |
|------------|--|

- | | |
|------------|------------------------------------|
| OM 48-0626 | 400gr slaphammer for medium pliers |
|------------|------------------------------------|

- | | |
|------------|-----------------------------------|
| OM 48-0627 | 700gr slaphammer for large pliers |
|------------|-----------------------------------|



LOCKING PLIERS WITH SLAPHAMMERS

LOCKING PLIERS WITH SLAPHAMMERS
A POWERFUL COMBINATION OF LOCKED GRIPPING STRENGTH AND CONTROLLED HAMMER ACTION.

- These stainless steel heavy duty locking pliers with slaphammers enable surgeons to more easily extract prostheses intramedullary nails and hip fracture plates.
- The large pliers offer maximum versatility- slaphammers can be attached in three places; on the end or either side. Small and medium pliers have end attachments only.
- If additional force is required, a mallet may be used on the hammer plate.
- For jaw length and tip widths refer to pages S25 and S26.



LOCKING PLIERS WITH SLAPHAMMER

OM 48-0612
6 3/4" (171mm) small
end and side attachments

OM 48-0614
8" (203mm) medium
end and side attachments

OM 48-0616
10" (254mm) large
end and side attachments



NEEDLE NOSE LOCKING PLIERS WITH SLAPHAMMER

OM 48-0620
9 1/2" (241mm) medium
end and side attachments

OM 48-0622
12" (305mm) large
end and side attachments

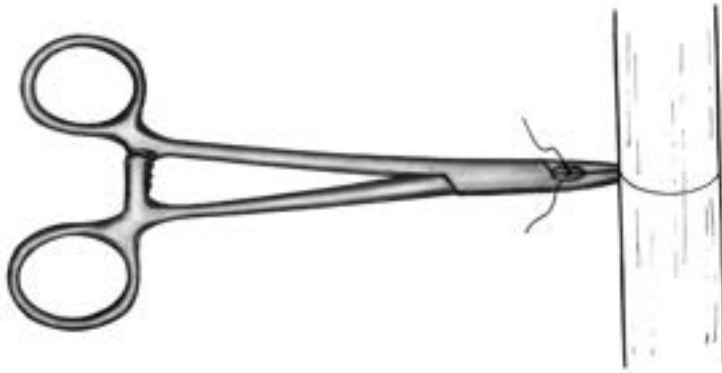

Follow these easy steps to twist and tighten cerclage wire:

1. Position wire around bone. Bend the ends of the wire slightly upwards.
2. Feed both twisted wire ends through the tongue and groove jaw and push out and up through the jaw fenestration.
3. Engage the ratchet. This will lock the wire into place. Turn the entire instrument, tightening the wire around the bone.

WIRE TWISTER AND TIGHTENER

OM 69-0846
6 1/4" (159mm)

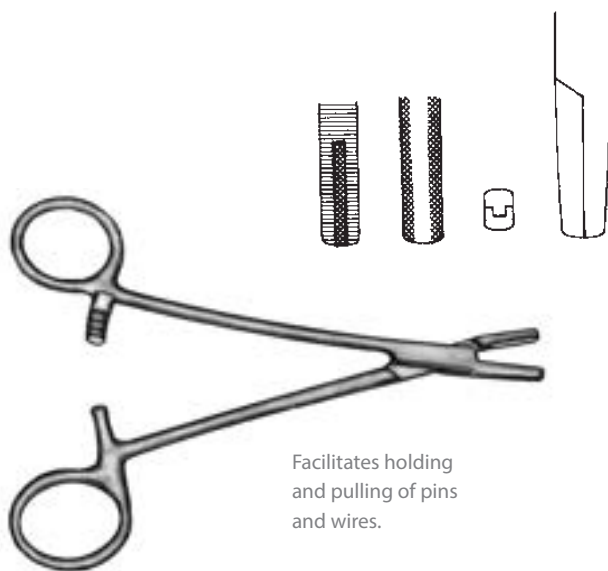

Facilitates holding and pulling of pins and wires.

WIRE PULLING FORCEPS

OM 46-0637
6 1/2" (165mm)
maximum capacity: 1mm



WIRE TWISTING FORCEPS

OM 48-0320
6" (152mm)
with carbide inserts
3mm tip



Carbide inserts provide a slide-proof grip on cerclage wire. Very useful in wiring femurs or greater trochanter.

WIRE TWISTING FORCEPS

OM 48-0322
8" (203mm)
with carbide inserts
4mm tip



Carbide inserts provide a slide-proof grip on cerclage wire. Very useful in wiring femurs or greater trochanter.

WIRE TWISTING FORCEPS

OM 48-0324
7 1/4" (184mm)
with carbide inserts
6mm tip



WIRE TIGHTENER

OM 46-0618
4 3/4" (121mm)



Useful for cerclage work in deep and restricted areas. Disassembles easily for cleaning.

LOUTE WIRE TIGHTENER

OM 46-0619
8 1/2" (216mm)
maximum capacity: 1.5mm
17 gauge cerclage wire

How to Use the Loute Wire Tightener

1. Loosen both knobs by turning counterclockwise until center pin disappears from view.
2. Pass wire around bone and feed both ends into center hole at the tip.
3. Use Wire Pulling Forceps (OM 46-0637) to pull ends through and hold wire taut while pushing the instrument close to the bone.
4. Turn lower (distal) knob clockwise to lock wire in place. Then turn upper (proximal) knob clockwise to pull in remaining slack from wire.
5. Balance instrument in one hand and rotate it with the other hand until resistance is felt. Then hold tightener shaft tight and turn lower (distal) knob clockwise until wire is cut.

Note: Hold instrument straight (do not tilt) while tightening

How to use the Corwin wire twister:

1. Wrap wire around bone and position ends next to each other.
2. Grasp both ends of wire with jaws.
3. Engage the ratchet to enforce solid clamping.
4. Stabilize wiring site.
5. Pull back on center ring repeatedly until wire has reached desired tension.
6. Disengage ratchet.



CORWIN WIRE TWISTER

OM 46-0582
6 1/4" (159mm)
with carbide inserts

This time-saving instrument twists wire quickly and smoothly.

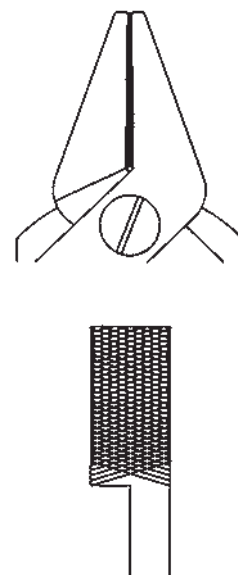

The OrthoMed Jet Wire Twister is designed to provide fast, smooth and even twisting of soft wire, saving time in the O.R. Now available for the first time in stainless steel. Suitable for the entire range of cerclage wire.

How to use the OrthoMed Jet Wire Twister:

1. Wrap wire around bone and position ends next to each other.
2. Grasp both ends of wire with jaw.
3. Engage the ratchet to enforce solid clamping.
4. Stabilize wiring site.
5. Pull back on t-handle repeatedly until wire has reached desired tension.
6. Disengage ratchet.

Note: Jaws can be customized. Please contact us for details.



JET WIRE TWISTER

OM 49-0810
11" (179mm)
10mm tip



Cannulation allows for easy feeding of wire around the bone.

WIRE PASSER (CANNULATED)

OM 48-0386 7" (178mm) 45mm diameter
 OM 48-0388 9 1/2" (241mm) 70mm diameter



DEMEL WIRE GUIDE

OM 48-0380 10 1/2" (267mm) 30mm diameter
 OM 48-0382 11 1/2" (292mm) 47mm diameter
 OM 48-0384 12 1/2" (318mm) 57mm diameter

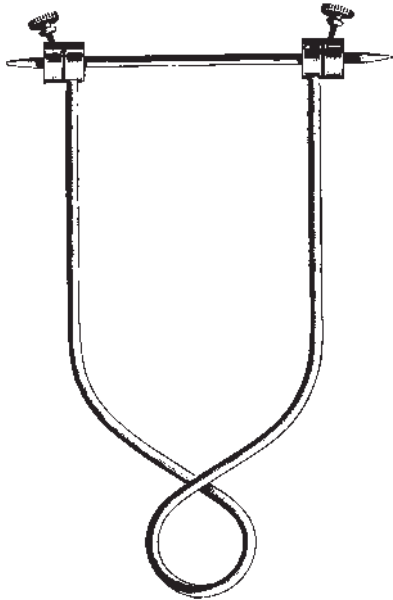

WIRE AND PIN TRACTOR (BOEHLER)

	inside length	inside width	pin included	pin size and dia.
OM 48-0326 small	90mm	75mm	OM 71-0432	5" 2.4mm
OM 48-0328 medium	160mm	90mm	OM 71-0434	7" 3.2mm
OM 48-0330 large	210mm	150mm	OM 71-0525	9" 4.0mm

Note: Each Wire and Pin Tractor comes with one single trocar round end Steinmann Pin as listed.



KIRSCHNER BOW

		max. jaw opening
OM 48-0270	5 3/4" (146mm) small	5" (127mm)
OM 48-0272	7 1/2" (191mm) large	8 1/2" (216mm)
OM 48-0274	9 1/2" (241mm) extra large	10" (254mm)

Note: Each Kirschner bow comes with three hooks.

BONE SCREWS AND PLATES



SECTION T

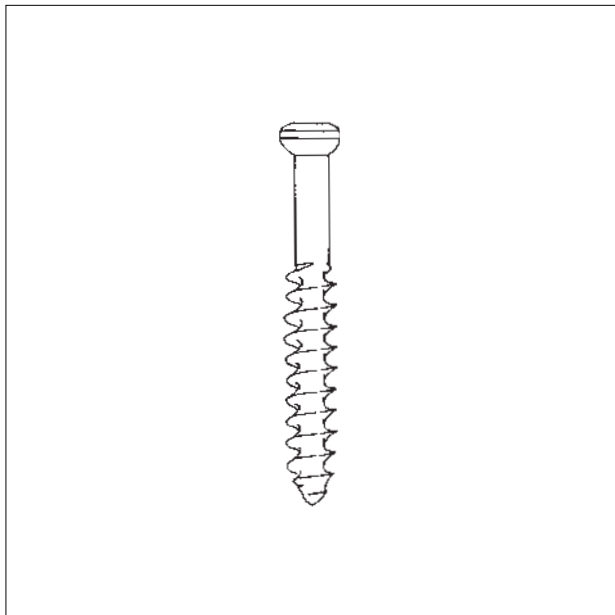





To fasten fractured bone segments together.

CONTENTS

Master Guide	1-2
Cortical Bone Screws	3-6
Malleolar Bone Screws	6
Cancellous Bone Screws	5-8
Cortex Self-Tapping Bone Screws	8-10
Bone Plates	11-19

TYPE OF SCREW	CORTICAL				CANCELOUS		CORTICAL	MALLEOLAR	CANCELOUS		
	OM NO.	SYN210006-20	SYN210006-38	SYN202006-40	SYN204010-110	SYN206010-60	SYN207010-60	SYN215025-30	SYN216030-120	SYN217045-150	SYN218020-06
thread diameter	1.5mm	2.0mm	2.7mm	2.5mm	3.5mm	4.0mm	4.0mm	4.5mm	6.5mm	6.5mm	6.5mm
	1.5mm	1.5mm	2.5mm	2.5mm	2.5mm	2.5mm	2.5mm	3.5mm	3.5mm	3.5mm	3.5mm
hexagonal socket size											
DRILL FOR GLIDING HOLE	OM NO.	48-0052	48-0054	48-0058	48-0063	48-0063	—	—	48-0067	48-0068	48-0068
	diameter	1.5mm	2.0mm	2.7mm	3.5mm	3.5mm	NONE	NONE	4.5mm	4.5mm	4.5mm
DRILL FOR THREADED HOLE	OM NO.	48-0051	48-0052	48-0054	48-0057	48-0054 or 48-0057	48-0054 or 48-0057	48-0061	48-0061	48-0061	48-0061
	diameter	1.1mm	1.5mm	2.0mm	2.5mm	2.0mm or 2.5mm	2.0mm or 2.5mm	3.2mm	3.2mm	3.2mm	3.2mm
TAP	OM NO.	48-0106	48-0108	48-0110	48-0112	48-0114	48-0114	48-0116	48-0122	48-0122	48-0122
	diameter	1.5mm	2.0mm	2.7mm	3.5mm	3.5mm	3.5mm	4.5mm	6.5mm	6.5mm	6.5mm

MASTER GUIDE - SCREWS, DRILL BITS, TAPS, INSTRUMENTS

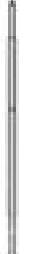
TYPE OF SCREW	CORTICAL				CANCELOUS		CORTICAL	MALLEOLAR	CANCELOUS		
	SYN210006-20	SYN211006-38	SYN202000-40	SYN2104010-110	SYN206010-60	SYN207010-60			SYN214014-095	SYN215025-30	SYN216030-120
thread diameter	1.5mm	2.0mm	2.7mm	3.5mm	4.0mm	4.0mm	4.5mm	4.5mm	6.5mm	6.5mm	6.5mm
hexagonal socket size	1.5mm	1.5mm	2.5mm	2.5mm	2.5mm	2.5mm	3.5mm	3.5mm	3.5mm	3.5mm	3.5mm
COUNTERSINK 	47-0920	47-0920	47-0922	47-0922	47-0922	47-0922	47-0926	47-0924	47-0926	47-0926	47-0926
pilot diameter	1.1mm	1.1mm	2.0mm	2.0mm	2.0mm	2.0mm	4.5mm	3.2mm	4.5mm	4.5mm	4.5mm
DEPTH GAUGE 	47-0934	47-0934	47-0936	47-0936	47-0936	47-0936	47-0940	47-0940	47-0940	47-0940	47-0940
graduation	24mm	24mm	50mm	50mm	50mm	50mm	100mm	100mm	100mm	100mm	100mm
QUICK COUPLING HANDLE 	47-0902	47-0902	47-0904	47-0904	47-0904	47-0904	47-0904	47-0904	47-0904	47-0904	47-0904
SCREWDRIVERS 	47-0950	47-0950	47-0953	47-0953	47-0953	47-0953	47-0954	47-0954	47-0954	47-0954	47-0954
			47-0952	47-0952	47-0952	47-0952	48-0352	48-0352	48-0352	48-0352	48-0352
			48-0350	48-0350	48-0350	48-0350	48-0479	48-0479	48-0479	48-0479	48-0479
			48-0480	48-0480	48-0480	48-0480					
RATCHETING HANDLE 	48-0052	48-0054	48-0058	48-0063	48-0063	48-0063	48-0067	—	48-0067	48-0068	48-0068
Ratcheting handle and hex shafts are designed to work together.											
HEX SHAFTS 											

Note: For the correct instrumentation, please refer to the chart at the beginning of this section.

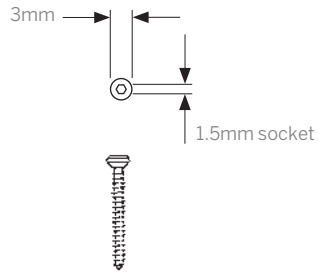

1.5MM CORTICAL SCREWS

Thread diameter: 1.5mm
Hexagonal socket: 1.5mm

	Total length
OM SYN210006	6mm
OM SYN210007	7mm
OM SYN210008	8mm
OM SYN210009	9mm
OM SYN210010	10mm
OM SYN210011	11mm
OM SYN210012	12mm
OM SYN210014	14mm
OM SYN210016	16mm
OM SYN210018	18mm
OM SYN210020	20mm

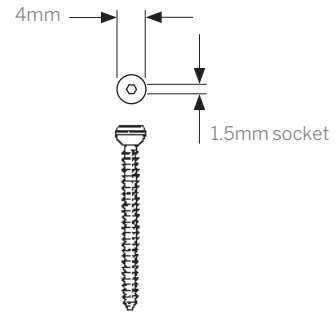

2.0MM CORTICAL SCREWS

Thread diameter: 2mm
Hexagonal socket: 1.5mm

	Total length
OM SYN211006	6mm
OM SYN211008	8mm
OM SYN211010	10mm
OM SYN211012	12mm
OM SYN211014	14mm
OM SYN211016	16mm
OM SYN211018	18mm
OM SYN211020	20mm
OM SYN211022	22mm
OM SYN211024	24mm
OM SYN211026	26mm
OM SYN211028	28mm
OM SYN211030	30mm
OM SYN211032	32mm
OM SYN211034	34mm
OM SYN211036	36mm
OM SYN211038	8mm

CORTICAL BONE SCREWS

Note: For the correct instrumentation, please refer to the chart at the beginning of this section.

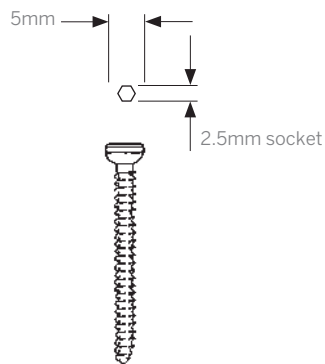

2.7MM CORTICAL SCREWS

Thread diameter: 2.7mm
Hexagonal socket: 2.5mm
Core diameter: 1.9mm
Head diameter: 5.0mm

	Total length
OM SYN202006	6mm
OM SYN202008	8mm
OM SYN202010	10mm
OM SYN202012	12mm
OM SYN202014	14mm
OM SYN202016	16mm
OM SYN202018	18mm
OM SYN202020	20mm
OM SYN202022	22mm
OM SYN202024	24mm
OM SYN202026	26mm
OM SYN202028	28mm
OM SYN202030	30mm
OM SYN202032	32mm
OM SYN202034	34mm
OM SYN202036	36mm
OM SYN202038	38mm
OM SYN202040	40mm

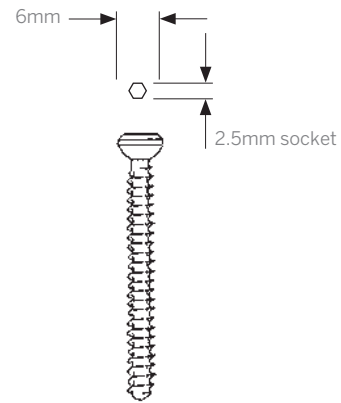

3.5MM CORTICAL SCREWS

Thread diameter: 3.5mm
Pitch: 1.25mm (fine thread)
Hexagonal socket: 2.5mm
Core diameter: 2.4mm
Head diameter: 6.0mm

	Total length
OM SYN204010	10mm
OM SYN204012	12mm
OM SYN204014	14mm
OM SYN204016	16mm
OM SYN204018	18mm
OM SYN204020	20mm
OM SYN204022	22mm
OM SYN204024	24mm
OM SYN204026	26mm
OM SYN204028	28mm
OM SYN204030	30mm
OM SYN204032	32mm
OM SYN204034	34mm
OM SYN204036	36mm
OM SYN204038	38mm
OM SYN204040	40mm
OM SYN204045	45mm
OM SYN204050	50mm
OM SYN204055	55mm
OM SYN204060	60mm
OM SYN204065	65mm
OM SYN204070	70mm
OM SYN204075	75mm
OM SYN204080	80mm
OM SYN204085	85mm
OM SYN204090	90mm
OM SYN204095	95mm
OM SYN204100	100mm
OM SYN204105	105mm
OM SYN204110	110mm

Note: For the correct instrumentation, please refer to the chart at the beginning of this section.

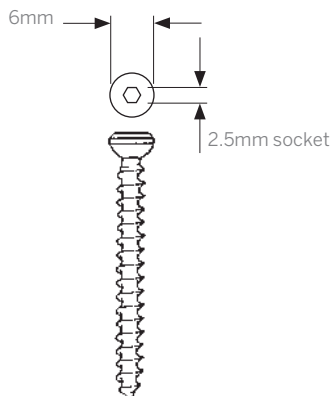

4.0MM CANCELLOUS SCREWS

Thread diameter: 4.0mm
 Pitch: 1.75mm (coarse thread)
 Hexagonal socket: 2.5mm
 Core diameter: 1.9mm
 Head diameter: 6.0mm

	Total length
OM SYN206010	12mm
OM SYN206012	14mm
OM SYN206014	16mm
OM SYN206016	18mm
OM SYN206018	20mm
OM SYN206020	22mm
OM SYN206022	24mm
OM SYN206024	26mm
OM SYN206026	28mm
OM SYN206028	30mm
OM SYN206030	32mm
OM SYN206032	35mm
OM SYN206035	40mm
OM SYN206040	45mm
OM SYN206045	50mm
OM SYN206050	55mm
OM SYN206055	60mm
OM SYN206060	65mm
OM SYN206065	70mm
OM SYN206070	75mm

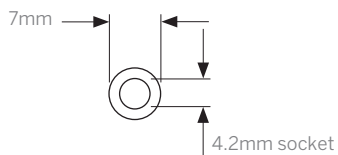

WASHER

OM 73-0509
 for 4mm cancellous screws

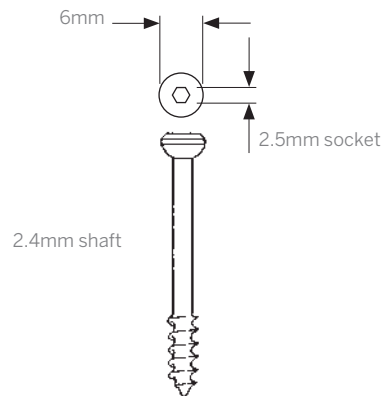

4.0MM CANCELLOUS SCREWS

Partially threaded
 Thread diameter: 4.0mm
 Shaft diameter: 2.4mm
 Hexagonal socket: 2.5mm
 Core diameter: 1.9mm
 Head diameter: 6.0mm

	Total length
OM SYN207010	10mm
OM SYN207012	12mm
OM SYN207014	14mm
OM SYN207016	16mm
OM SYN207018	18mm
OM SYN207020	20mm
OM SYN207022	22mm
OM SYN207024	24mm
OM SYN207026	26mm
OM SYN207028	28mm
OM SYN207030	30mm
OM SYN207035	35mm
OM SYN207040	40mm
OM SYN207045	45mm
OM SYN207050	50mm
OM SYN207055	55mm
OM SYN207060	60mm

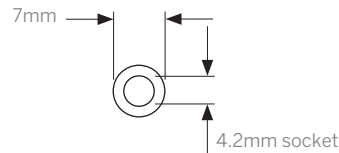

WASHER

OM 73-0509
 for 4mm cancellous screws

CORTICAL BONE SCREWS

Note: For the correct instrumentation, please refer to the chart at the beginning of this section.

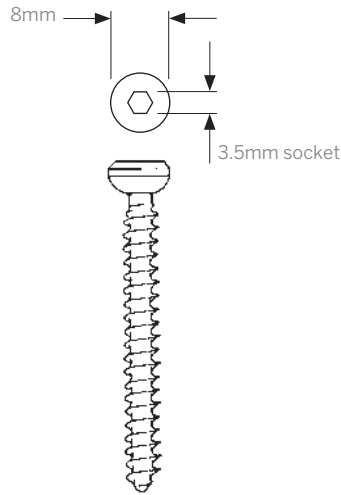

4.5MM CORTICAL SCREWS

Fully threaded
Thread diameter: 4.5mm
Hexagonal socket: 3.5mm

	Total length		Total length
OM SYN214014	14mm	OM SYN214058	58mm
OM SYN214016	16mm	OM SYN214060	60mm
OM SYN214018	18mm	OM SYN214062	62mm
OM SYN214020	20mm	OM SYN214064	64mm
OM SYN214022	22mm	OM SYN214066	66mm
OM SYN214024	24mm	OM SYN214068	68mm
OM SYN214026	26mm	OM SYN214070	70mm
OM SYN214028	28mm	OM SYN214072	72mm
OM SYN214030	30mm	OM SYN214076	76mm
OM SYN214032	32mm	OM SYN214080	80mm
OM SYN214034	34mm	OM SYN214085	85mm
OM SYN214036	36mm	OM SYN214090	90mm
OM SYN214038	38mm	OM SYN214095	95mm
OM SYN214040	40mm	OM SYN214100	100mm
OM SYN214042	42mm	OM SYN214105	105mm
OM SYN214044	44mm	OM SYN214110	110mm
OM SYN214046	46mm	OM SYN214115	115mm
OM SYN214048	48mm	OM SYN214120	120mm
OM SYN214050	50mm	OM SYN214125	125mm
OM SYN214052	52mm	OM SYN214130	130mm
OM SYN214054	54mm	OM SYN214135	135mm
OM SYN214056	56mm	OM SYN214140	140mm

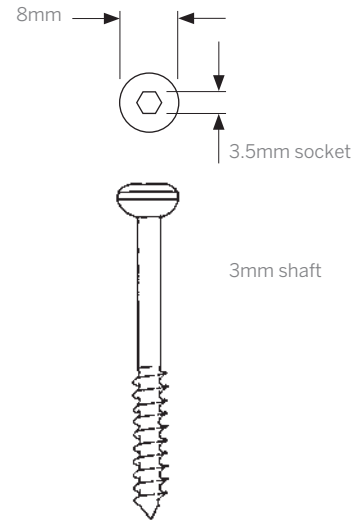

4.5MM MALLEOLAR SCREWS

Partially threaded
Thread diameter: 4.5mm
Shaft diameter: 3mm
Hexagonal socket: 3.5mm

	Total length
OM SYN215025	25mm
OM SYN215030	30mm
OM SYN215035	35mm
OM SYN215040	40mm
OM SYN215045	45mm
OM SYN215050	50mm
OM SYN215055	55mm
OM SYN215060	60mm
OM SYN215065	65mm
OM SYN215070	70mm

Note: For the correct instrumentation, please refer to the chart at the beginning of this section.



6.5MM CANCELLOUS SCREWS

Thread diameter: 6.5mm
 Shaft diameter: 4.5mm
 Partially threaded: 16mm
 Hexagonal socket: 3.5mm

	Total length
OM SYN216030	30mm
OM SYN216035	35mm
OM SYN216040	40mm
OM SYN216045	45mm
OM SYN216050	50mm
OM SYN216055	55mm
OM SYN216060	60mm
OM SYN216065	65mm
OM SYN216070	70mm
OM SYN216075	75mm
OM SYN216080	80mm
OM SYN216085	85mm
OM SYN216090	90mm
OM SYN216095	95mm
OM SYN216100	100mm
OM SYN216105	105mm
OM SYN216110	110mm

6.5MM CANCELLOUS SCREWS

Thread diameter: 6.5mm
 Shaft diameter: 4.5mm
 Partially threaded: 32mm
 Hexagonal socket: 3.5mm

	Total length
OM SYN217045	45mm
OM SYN217050	50mm
OM SYN217055	55mm
OM SYN217060	60mm
OM SYN217065	65mm
OM SYN217070	70mm
OM SYN217075	75mm
OM SYN217080	80mm
OM SYN217085	85mm
OM SYN217090	90mm
OM SYN217095	95mm
OM SYN217100	100mm
OM SYN217105	105mm
OM SYN217110	110mm
OM SYN217115	115mm
OM SYN217120	120mm
OM SYN217125	125mm
OM SYN217130	130mm
OM SYN217135	135mm
OM SYN217140	140mm
OM SYN217145	145mm
OM SYN217150	150mm

CANCELLOUS AND CORTEX SELF-TAPPING BONE SCREWS

Note: For the correct instrumentation, please refer to the chart at the beginning of this section.

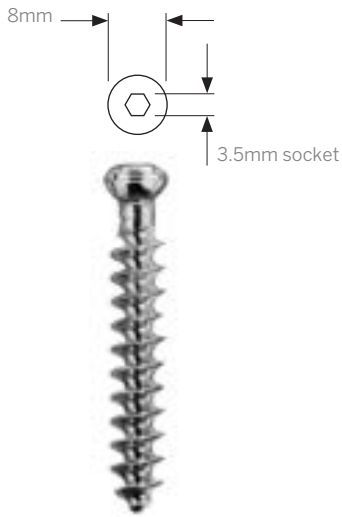

6.5MM CANCELLOUS SCREWS

Fully threaded
Thread diameter: 6.5mm
Hexagonal socket: 3.5mm

	Total length
OM SYN218020	20mm
OM SYN218025	25mm
OM SYN218030	30mm
OM SYN218035	35mm
OM SYN218040	40mm
OM SYN218045	45mm
OM SYN218050	50mm
OM SYN218055	55mm
OM SYN218060	60mm
OM SYN218065	65mm
OM SYN218070	70mm
OM SYN218075	75mm
OM SYN218080	80mm
OM SYN218085	85mm
OM SYN218090	90mm
OM SYN218095	95mm
OM SYN218100	100mm
OM SYN218105	105mm
OM SYN218110	110mm



NUT

OM 73-0813
for 4.5mm cortical and malleolar screws
8mm across flats

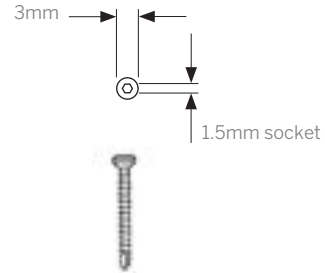

1.5MM CORTEX SELF-TAPPING SCREWS

Thread diameter: 1.5mm
Hexagonal socket: 1.5mm

	Total length
OM SYN210806	6mm
OM SYN210807	7mm
OM SYN210808	8mm
OM SYN210809	9mm
OM SYN210810	10mm
OM SYN210811	11mm
OM SYN210812	12mm
OM SYN210814	14mm
OM SYN210816	16mm
OM SYN210818	18mm
OM SYN210820	20mm

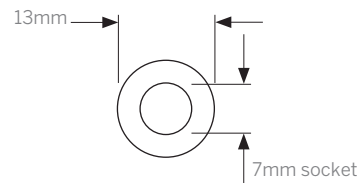

WASHER

OM 73-0724
for 4.5mm malleolar screws and 6.5mm cancellous screws



WRENCH

OM 47-0914
for nut OM 73-0813

Note: For the correct instrumentation, please refer to the chart at the beginning of this section.

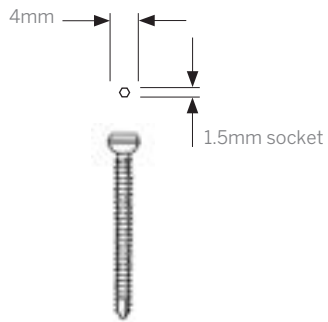

2.0MM CORTEX SELF-TAPPING SCREWS

Thread diameter: 2mm
Hexagonal socket: 1.5mm

	Total length
OM SYN211806	6mm
OM SYN211808	8mm
OM SYN211810	10mm
OM SYN211812	12mm
OM SYN211814	14mm
OM SYN211816	16mm
OM SYN211818	18mm
OM SYN211820	20mm
OM SYN211822	22mm
OM SYN211824	24mm
OM SYN211826	26mm
OM SYN211828	28mm
OM SYN211830	30mm
OM SYN211832	32mm
OM SYN211834	34mm
OM SYN211836	36mm
OM SYN211840	40mm

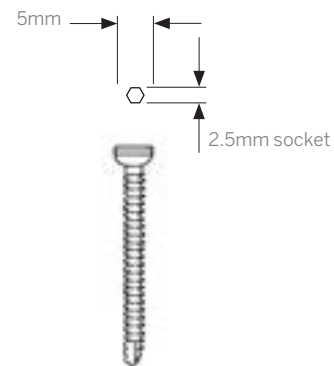

2.7MM CORTEX SELF-TAPPING SCREWS

Thread diameter: 2.7mm
Hexagonal socket: 2.5mm

	Total length
OM SYN202806	6mm
OM SYN202808	8mm
OM SYN202810	10mm
OM SYN202812	12mm
OM SYN202814	14mm
OM SYN202816	16mm
OM SYN202818	18mm
OM SYN202820	20mm
OM SYN202822	22mm
OM SYN202824	24mm
OM SYN202826	26mm
OM SYN202828	28mm
OM SYN202830	30mm
OM SYN202832	32mm
OM SYN202834	34mm
OM SYN202840	40mm

Note: For the correct instrumentation, please refer to the chart at the beginning of this section.

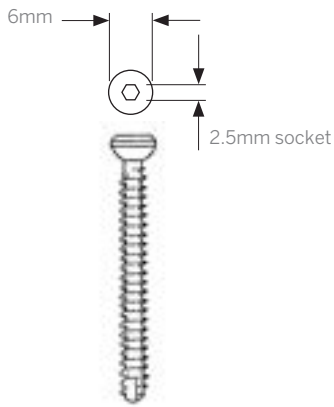

3.5MM CORTEX SELF-TAPPING SCREWS

Thread diameter: 3.5mm
Pitch: 1.25mm (fine thread)
Hexagonal socket: 2.5mm

	Total length		Total length
OM SYN 204810	10mm	OM SYN204840	40mm
OM SYN204812	12mm	OM SYN204845	45mm
OM SYN204814	14mm	OM SYN204850	50mm
OM SYN204816	16mm	OM SYN204855	55mm
OM SYN204818	18mm	OM SYN204860	60mm
OM SYN204820	20mm	OM SYN204865	65mm
OM SYN204822	22mm	OM SYN204870	70mm
OM SYN204824	24mm	OM SYN204875	75mm
OM SYN204826	26mm	OM SYN204880	80mm
OM SYN204828	28mm	OM SYN204885	85mm
OM SYN204830	30mm	OM SYN204890	90mm
OM SYN204832	32mm	OM SYN204895	95mm
OM SYN204834	34mm	OM SYN204900	100mm
OM SYN204836	36mm	OM SYN204905	105mm
OM SYN204838	38mm	OM SYN204910	110mm

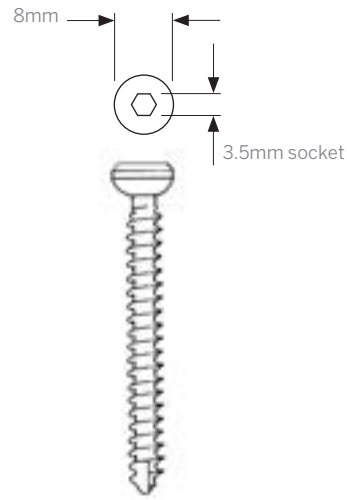

4.5MM CORTEX SELF-TAPPING SCREWS

Fully threaded
Thread diameter: 4.5mm
Hexagonal socket: 3.5mm

	Total length		Total length
OM SYN214814	14mm	OM SYN214844	44mm
OM SYN214816	16mm	OM SYN214846	46mm
OM SYN214818	18mm	OM SYN214848	48mm
OM SYN214820	20mm	OM SYN214850	50mm
OM SYN214822	22mm	OM SYN214852	52mm
OM SYN214824	24mm	OM SYN214854	54mm
OM SYN214826	26mm	OM SYN214856	56mm
OM SYN214828	28mm	OM SYN214858	58mm
OM SYN214830	30mm	OM SYN214860	60mm
OM SYN214832	32mm	OM SYN214862	62mm
OM SYN214834	34mm	OM SYN214864	64mm
OM SYN214836	36mm	OM SYN214866	66mm
OM SYN214838	38mm	OM SYN214868	68mm
OM SYN214840	40mm	OM SYN214870	70mm
OM SYN214842	42mm		



MINI PLATES STRAIGHT

Width: 5mm
 Thickness: 1mm
 Distance between holes: 6mm
 Recommended screws:
 2mm Cortical (OM SYN211006 through OM SYN211038)

	Total Length	Number of holes
OM SYN243130	17mm	3
OM SYN243140	23mm	4
OM SYN243150	29mm	5
OM SYN243160	35mm	6

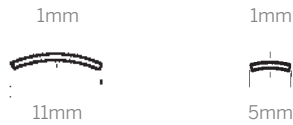

MINI L- AND T-PLATES

Width: 11mm/5mm
 Thickness: 1mm
 Distance between holes: 6mm
 Recommended screws:
 2mm Cortical (OM SYN211006 through OM SYN211038)

	Total Length	Number of holes
OM SYN243330	20mm	4
OM SYN243340	20mm	4
OM SYN243310	19mm	4
OM SYN243320	19mm	4
OM SYN243410	18mm	4

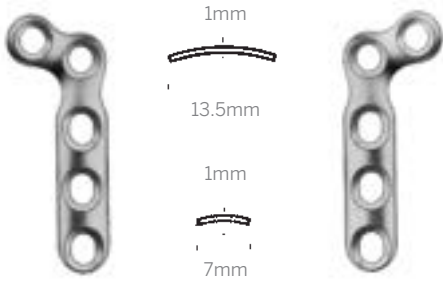

OM SYN242440
"L" oblique left

OM SYN242340
"L" oblique right

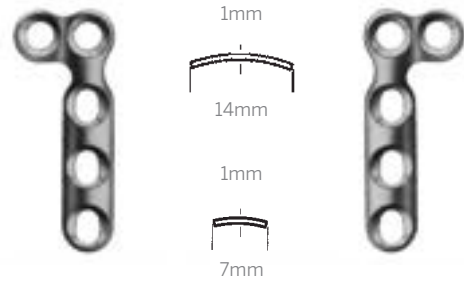

OM SYN242310
"L" left

OM SYN242320
"L" right

L-PLATES

Width: 13.5mm/7mm and 14mm/7mm

Thickness: 1mm

Recommended screws:

2.7mm Cortical (OM SYN202006 through OM SYN202040)

	Length	Number of holes
OM SYN242330	35mm	5 "L" oblique left
OM SYN242340	35mm	5 "L" oblique right
OM SYN242310	32mm	5 "L" left
OM SYN242320	32mm	5 "L" right

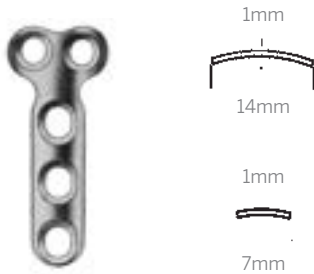

T-PLATES

Width: 14mm/7mm

Thickness: 1mm

Recommended screws:

2.7mm Cortical (OM SYN202006 through OM SYN202040)

	Length	Number of holes
OM SYN242410	32mm	5



MULTIPLE FRAGMENT PLATES

Width: 15mm

Thickness: 1.2mm

Recommended screws:

2.7mm Cortical (OM SYN202006 through OM SYN202040)

	Length	Number of holes
OM 76-0262	44mm	7



	Length	Number of holes
OM SYN244020	20mm	2
OM SYN244040	36mm	4
OM SYN244050	44mm	5
OM SYN244060	52mm	6

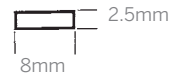

MINI COMPRESSION PLATES

Width: 8mm
 Thickness: 2mm/2.5mm
 Distance between holes: 8mm
 Distance between center holes: 12mm
 Recommended screws:
 2.7mm Cortical (OM SYN202006 through OM SYN202040)

	Length	Number of holes
OM SYN244070	60mm	7
OM SYN244080	68mm	8
OM SYN244090	76mm	9
OM SYN244100	84mm	10
OM SYN244120	100mm	12

Diameter of holes: 3.3mm

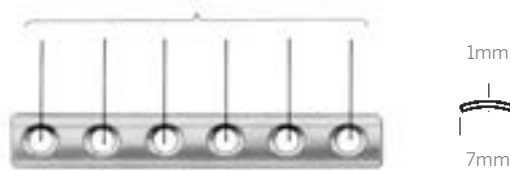

QUARTER TUBULAR PLATES

Width: 7mm
 Thickness: 1mm
 Distance between holes: 8mm
 Recommended screws:
 2.7mm Cortical (OM SYN202006 through OM SYN202040)

	Length	Number of holes
OM SYN242030	23mm	3
OM SYN242040	31mm	4
OM SYN242050	39mm	5
OM SYN242060	47mm	6
OM SYN242070	55mm	7
OM SYN242080	63mm	8
OM SYN242090	71mm	9



SMALL COMPRESSION PLATES

Width: 10mm

Thickness: 3mm

Distance between holes: 12mm

Distance between center holes: 16mm

Recommended screws:

3.5mm Cortical (OM SYN204010 through OM SYN204110)

4.0mm Cancellous (OM SYN206010 through OM SYN206060)

	Length	Number of holes
OM SYN248020	25mm	2
OM SYN248030	37mm	3
OM SYN248040	49mm	4
OM SYN248050	61mm	5
OM SYN248060	73mm	6
OM SYN248070	85mm	7
OM SYN248080	97mm	8
OM SYN248100	121mm	10
OM SYN248120	145mm	12

CLOVERLEAF PLATES

Width: 36mm/15mm

Thickness: 1.2mm

Recommended screws:

head: 3.5mm Cancellous (OM SYN206010 through OM SYN206060)

shaft: 4.5mm Cortical (OM SYN214014 through OM SYN214095)

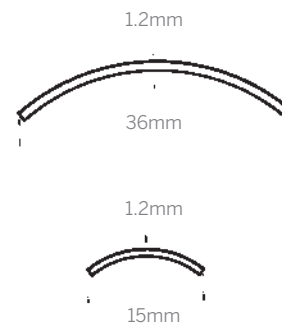

	Length	Number of holes
OM SYN241830	88mm	3
OM SYN241840	105mm	4



SMALL T-PLATES

Width: 10mm
 Thickness: 1.2mm
 Recommended screws:
 3.5mm Cortical (OM SYN204010 through OM SYN204110)

	Length	Number of holes
OM SYN241130	45mm	3 X 3
OM SYN241140	58mm	4 X 4
OM SYN241150	66mm	3 X 5
OM SYN241160	78mm	4 X 6

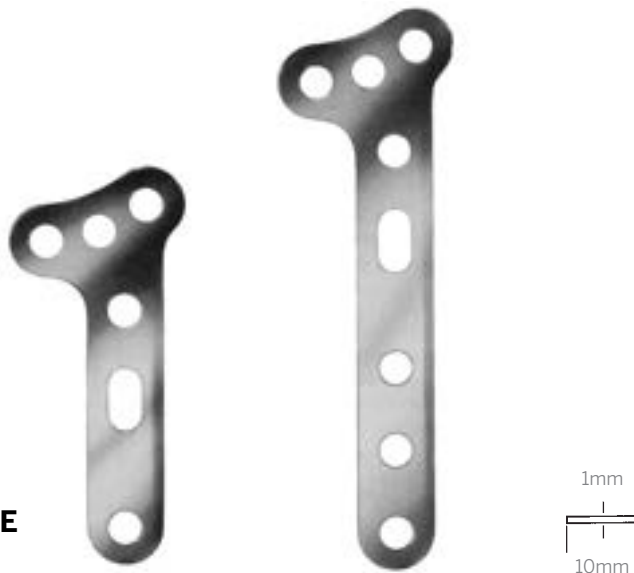

SMALL T-PLATES OBLIQUE

Width: 10mm
 Thickness: 1.5mm
 Recommended screws:
 3.5mm Cortical (OM SYN204010 through OM SYN204110)

	Length	Number of holes
OM SYN241230	54mm	3 X 3
OM SYN241250	75mm	3 X 5

BONE PLATES FOR 3.5MM AND 4.5MM SCREWS

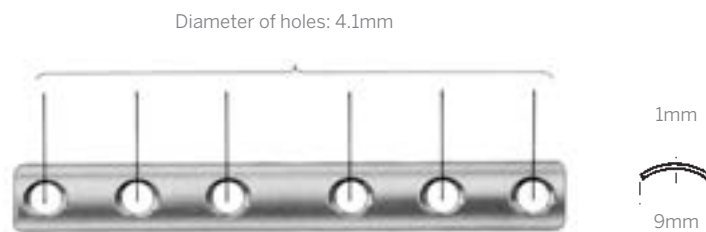

ONE-THIRD TUBULAR PLATES

Width: 9mm

Thickness: 1mm

Distance between holes: 12mm

Distance between center holes: 16mm

Recommended screws:

3.5mm Cortical (OM SYN204010 through OM SYN204110)

4.0mm Cancellous (OM SYN206010 through OM SYN206060)

4.0mm Cancellous (OM SYN207010 through OM SYN207060)

	Length	Number of holes
OM SYN241320	25mm	2
OM SYN241330	37mm	3
OM SYN241340	49mm	4
OM SYN241350	61mm	5
OM SYN241360	73mm	6
OM SYN241370	85mm	7
OM SYN241380	97mm	8

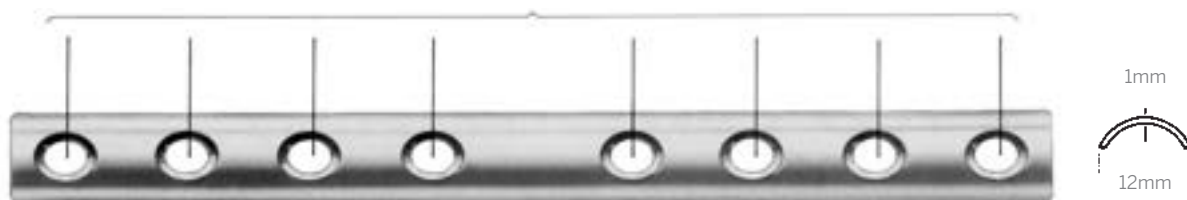

SEMI-TUBULAR PLATES

Width: 12mm

Thickness: 1mm

Distance between holes: 16mm

Distance between center holes: 26mm

Recommended screws:

4.5mm Cortical (OM SYN214014 through OM SYN214095)

4.5mm Malleolar (OM SYN215015 through OM SYN215070)

	Length	Number of holes
OM SYN222020	39mm	2
OM SYN222030	55mm	3
OM SYN222040	71mm	4
OM SYN222050	87mm	5
OM SYN222060	103mm	6
OM SYN222070	119mm	7
OM SYN222080	135mm	8
OM SYN222090	151mm	9
OM SYN222100	167mm	10
OM SYN222110	183mm	11
OM SYN222120	199mm	12

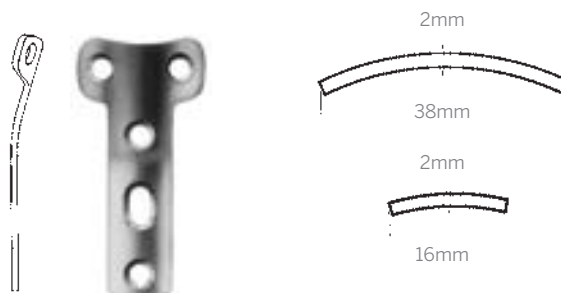

T-PLATES

Width: 38mm/17mm

Thickness: 2mm

Recommended screws:

4.5mm Cortical (OM SYN214014 through OM SYN214095)

	Length	Number of holes
OM SYN240130	68mm	3
OM SYN240140	84mm	4
OM SYN240150	105mm	5
OM SYN240160	116mm	6
OM SYN240180	148mm	8

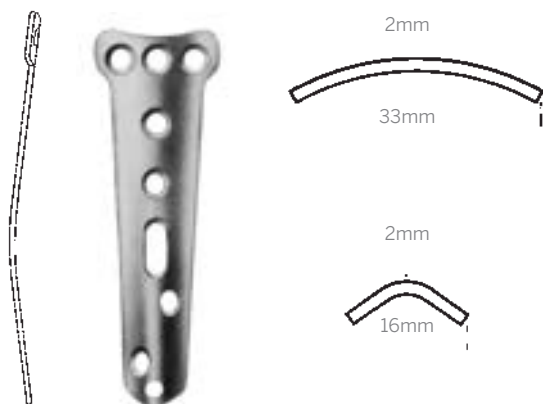

SPOON PLATES

Width: 33mm/16mm

Thickness: 2mm

Recommended screws:

4.5mm Cortical (OM SYN214014 through OM SYN214095)

	Length	Number of holes
OM SYN240050	100mm	5
OM SYN240060	120mm	6

BONE PLATES FOR 4.5MM SCREWS

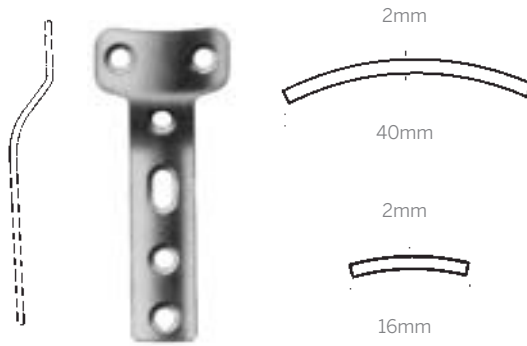

T-BUTTRESS PLATES

Width: 40mm/16mm

Thickness: 2mm

Recommended screws:

4.5mm Cortical (OM SYN214014 through OM SYN214095)

	Length	Number of holes
OM SYN240340	80mm	4
OM SYN240350	103mm	5
OM SYN240360	116mm	6

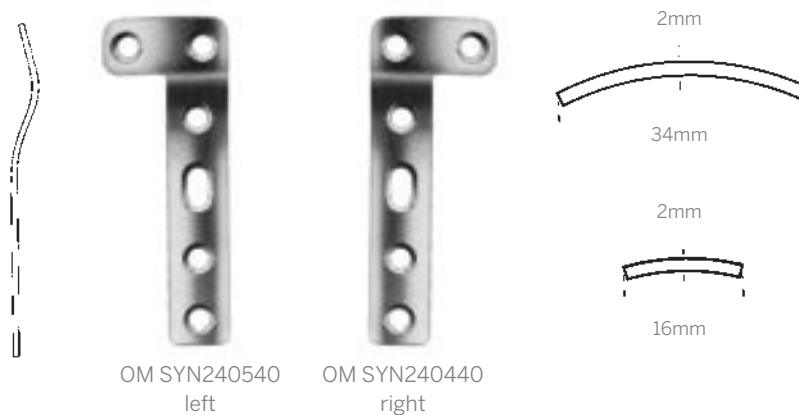

L-BUTTRESS PLATES

Width: 34mm/16mm

Thickness: 2mm

Recommended screws:

4.5mm Cortical (OM SYN214014 through OM SYN214095)

	Length	Number of holes
OM SYN240540	Left	87mm 4
OM SYN240440	Right	87mm 4



OM SYN224060



Both ends are notched to hold tension device
OM 47-0910 or OM 47-0911.

NARROW COMPRESSION PLATES

Width: 12mm
 Thickness: 3.8mm
 Distance between holes: 16mm
 Distance between center holes: 25mm
 Recommended screws:
 4.5mm Cortical (OM SYN214014 through OM SYN214095)
 4.5mm Malleolar (OM SYN215025 through OM SYN215070)
 4.5mm Cancellous (OM SYN216030 through OM SYN216120)
 (OM SYN217045 through OM SYN217150)
 (OM SYN218020 through OM SYN218110)

	Length	Number of holes
OM SYN224020	39mm	2
OM SYN224030	55mm	3
OM SYN224040	71mm	4
OM SYN224050	87mm	5
OM SYN224060	103mm	6
OM SYN224070	119mm	7
OM SYN224080	135mm	8
OM SYN224090	151mm	9
OM SYN224100	167mm	10
OM SYN224110	183mm	11
OM SYN224120	199mm	12
OM SYN224130	215mm	13
OM SYN224140	231mm	14
OM SYN224150	247mm	15
OM SYN224160	263mm	16

Diameter of holes: 4.8mm



OM SYN226080



Both ends are notched to hold tension device
OM 47-0910 or OM 47-0911.

BROAD COMPRESSION PLATES

Width: 16mm
 Thickness: 4.5mm
 Distance between holes: 16mm
 Distance between center holes: 25mm
 Recommended screws:
 4.5mm Cortical (OM SYN214014 through OM SYN214095)
 4.5mm Malleolar (OM SYN215025 through OM SYN215070)
 4.5mm Cancellous (OM SYN216030 through OM SYN216120)
 (OM SYN217045 through OM SYN217150)
 (OM SYN218020 through OM SYN218110)

	Length	Number of holes
OM SYN226060	103mm	6
OM SYN226070	119mm	7
OM SYN226080	135mm	8
OM SYN226090	151mm	9
OM SYN226100	167mm	10
OM SYN226110	183mm	11
OM SYN226120	199mm	12
OM SYN226130	215mm	13
OM SYN226140	231mm	14
OM SYN226150	247mm	15
OM SYN226160	263mm	16
OM SYN226180	295mm	18

BONE SCREW MANAGEMENT



SECTION U

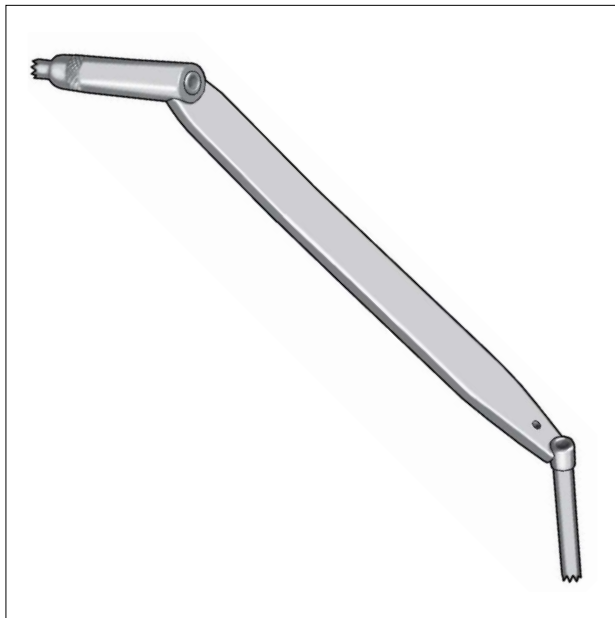

To implant bone screws and plates during internal fracture fixation.

CONTENTS

Drill Bits	1
Sterilization Case	2
Countersinks	3
Taps	4
Depth Gauges/Couping Handles	5
Drill Guides and Sleeves	6-9
Screwdrivers	10-14
Tension Devices	15-16
Wrenches	16-17
Bending Instruments	18-25
Screw Removal Set	26-27

ORTHO+MED
The Surgical Instrument Specialists

Note: For the correct instrumentation, please refer to the chart on pages T1-T2 or Section BB. Please inquire about any style or size drill bit not shown here.

DRILL BITS

With quick coupling ends



	diameter	Overall length	Working length	Flute length
OM 48-0051	1.1mm	60mm	35mm	20mm
OM 48-0052	1.5mm	85mm	60mm	23mm
OM SYN310510	1.8mm	100mm	75mm	45mm
OM 48-0054	2.0mm	100mm	75mm	50mm
OM 48-0057	2.5mm	110mm	85mm	50mm
OM SYN310.23	2.5mm	180mm	153mm	45mm
OM 48-0058	2.7mm	100mm	75mm	50mm
OM 48-0061	3.2mm	145mm	120mm	50mm
OM 48-0060	3.2mm	195mm	170mm extra long	50mm
OM 48-0063	3.5mm	110mm	85mm	50mm
OM 48-0050	3.5mm	195mm	170mm extra long	50mm
OM 48-0066	5.5mm	195mm	170mm extra long	55mm
OM 48-0067	4.5mm	145mm	120mm	50mm
OM 48-0068	4.5mm	195mm	170mm extra long	50mm
OM 48-0069	6.0mm	195mm	170mm extra long	60mm

To drill gliding and threaded holes.

Designed to fit quick coupling handles.
OM 47-0902
OM 47-0904
OM 47-0960



Enlarged to show detail.

DRILL BITS

With round drill chuck end



	diameter	Overall length	Working length
OM 48-0070	1.0mm	55mm	25mm
OM 48-0071	1.5mm	70mm	30mm
OM 48-0073	2.0mm	85mm	38mm
OM 48-0076	2.5mm	95mm	43mm
OM 48-0077	2.7mm	85mm	32mm
OM 48-0080	3.2mm	106mm	48mm
OM 48-0079	3.2mm	180mm	70mm
OM 48-0081	3.5mm	112mm	52mm
OM 48-0082	3.5mm	180mm	70mm extra long
OM 48-0085	4.5mm	180mm	70mm extra long
OM 48-0086	6.0mm	180mm	70mm extra long

Designed to fit any Jacobs chuck drill.



Enlarged to show detail.

THREE-FLUTED DRILL BITS

With quick coupling ends



	diameter	Overall length	Working length	Flute length
OM 47-0986	2.5mm	230mm	205mm	30mm calibrated
OM 47-0979	3.2mm	230mm	205mm	30mm calibrated
OM 47-0981	4.5mm	195mm	170mm	55mm not calibrated

Note: Custom lengths and diameters can be manufactured upon special order.
Cannulated drill bits from 5mm to 12mm in diameter are also available by special order.



Enlarged to show detail.

STERILIZATION CASE

Note: The OrthoMed Drill Bit Sterilization Case holds 5" drill bits for sterilization and storage.

- Drill bit sizes and OrthoMed part numbers are clearly noted on the inside of case for quick identification and reordering.
- Lid opens and raises the internal tray containing drill bits up for easy access.
- Lid folds back and acts as a support to hold the case in an upright position – taking up less room in the O.R.
- When closing lid, the internal tray is lowered and contents are held in place, preventing shifting.
- Top of case locks when closed helping to prevent accidental opening.
- Case has a one piece design – eliminates the possibility of losing or switching case parts.
- Anodized aluminum case is light-weight and built to withstand abuse.
- Fully autoclavable to 270°F.

Designed to provide easy access and identification.



Case in open upright position.



Case in closed position.

5" DRILL BIT STERILIZATION CASE

Holds 5" drill bits for sterilization and storage.

OM 48-0100

5 1/2" X 4 1/4" X 3/4"

5" (127mm) Jacob chuck drill bits are available from OrthoMed and sold separately.

OM 48-0129	1.0mm (2 ea.)	OM 48-0137	3.2mm (2 ea.)
OM 48-0130	1.5mm (2 ea.)	OM 48-0138	3.5mm (2 ea.)
OM 48-0132	2.0mm (2 ea.)	OM 48-0140	4.0mm (2 ea.)
OM 48-0134	2.4mm (2 ea.)	OM 48-0142	4.7mm (2 ea.)
OM 48-0136	2.7mm (2 ea.)	OM 48-0143	6.0mm (1 ea.)

OM 48-0135 2.5mm

CANNULATED DRILL BITS

with quick coupling ends

OM SYN310.67	2.7mm	OM SYN310.66	4.5mm
OM SYN310.65	3.2mm	OM SYN310.68	3.5mm

Note: Countersinks: used to prepare correct seating for screw head. For correct instrumentation, please refer to the chart on pages T1-T2 or Section BB.



For mini screws
1.5 / 2.0mm.

MINI COUNTERSINK

OM 47-0920
2 1/4" (57mm)
1.1mm tip
quick coupling end



For small screws
2.7 / 3.5 / 4.0mm.

SMALL COUNTERSINK

OM 47-0922
2 3/4" (70mm)
2.0mm tip
quick coupling end



For malleolar screws.

MALLEOLAR COUNTERSINK

OM 47-0924
4 3/4" (121mm)
3.2mm tip
quick coupling end

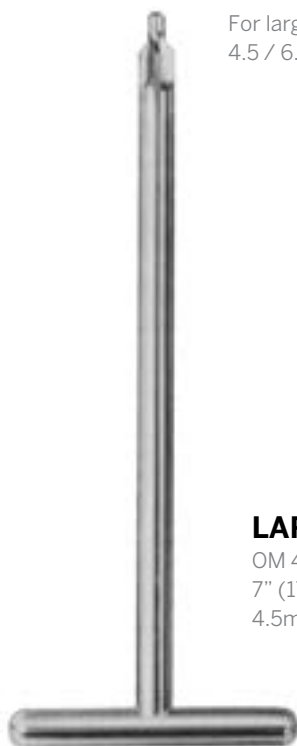

For large screws
4.5 / 6.5mm.

LARGE COUNTERSINK

OM 47-0926
7" (178mm)
4.5mm tip



Converts QC end to round end with
three flat sides for power drills.

ADAPTOR (POWER DRILL)

OM 45-0002
2 1/2" (64mm)

TAPS

Note: Taps with quick coupling ends.

Note: Taps are used to prepare threaded path for insertion of bone screws. For the correct instrumentation, please refer to the chart on pages T1-T2 or Section BB

				
For cortical screws thread pitch 0.5mm.	For cortical screws thread pitch 0.6mm.	For cortical screws thread pitch 1.0mm.	For cortical screws thread pitch 1.25mm. Fine thread.	For 3.5 and 4.0mm cancellous screws thread pitch 1.75mm. Coarse thread.
OM 48-0106 2"(51mm) 1.5mm diameter	OM 48-0108 2 1/4"(57mm) 2.0mm diameter	OM 48-0110 4"(102mm) 2.7mm diameter	OM 48-0112 4 1/2"(108mm) 3.5mm diameter	OM 48-0114 4 1/2"(108mm) 3.5mm diameter

Note: Taps with quick coupling ends for 4.5mm cortical and 4.5mm malleolar (shaft) screw.

Note: Taps with quick coupling ends calibrated, with centimeter graduations.

			
			For cortical screws OM 48-0104 7" (178mm) 3.5mm diameter
			For cortical screws OM 48-0102 7" (178mm) 4.5mm diameter
OM 48-0116 5"(127mm) 4.5mm diameter	OM 48-0118 5"(127mm) 4.5mm diameter long thread	OM 48-0120 7 1/2"(191mm) 4.5mm diameter extra long	For cancellous screws OM 48-0122 8" (203mm) 6.5mm diameter

DEPTH GAUGES AND QUICK COUPLING HANDLES

Note: For holding quick coupling drills, countersinks, taps and screwdrivers.

Note: To help select the correct size for your needs – refer to our cross-reference chart on pages T1-T2.



MINI QUICK COUPLING HANDLE

OM 47-0902
4 1/4" (108mm)
for mini screw set



SMALL QUICK COUPLING HANDLE

OM 47-0904
4 1/2" (114mm)
for small and large screw sets

Phenolic handles are autoclavable to 290°F (143°C)



SMALL QUICK COUPLING HANDLE

OM 47-0960
3 1/2" (89mm)
for small screw set

Note: Used to determine screw length required during internal fracture fixation (mm graduated). Snaps apart for easy cleaning.
Important Note: When not in use retract measuring end inside gauge.

MINI SCREW DEPTH GAUGE

OM 47-0934
4 3/4" (121mm)
up to 30mm



SMALL SCREW DEPTH GAUGE

OM 47-0936
6 1/4" (159mm)
up to 50mm



LARGE SCREW DEPTH GAUGE

OM 47-0940
8 3/4" (222mm)
up to 100mm



X-LARGE SCREW DEPTH GAUGE

OM 47-0935
11" (279mm)
up to 120mm



DOUBLE DRILL SLEEVES

Note: Drill guides and sleeves: used with drills and taps to place accurate holes and protect surrounding tissue.



DOUBLE DRILL SLEEVE

1.5mm/1.1mm
OM 47-0968
for 1.1mm and
1.5mm drill bits
and tap for 1.5mm
cortical screws



DOUBLE DRILL SLEEVE

2.0mm/1.5mm
OM 47-0966
for 1.5mm and
2.0mm drill bits
and tap for 2.0mm
cortical screw



DOUBLE DRILL SLEEVE

2.7mm/2.0mm
OM 48-0002
for 2.0mm and
2.7mm drill bits
and tap for 2.7mm
cortical screws

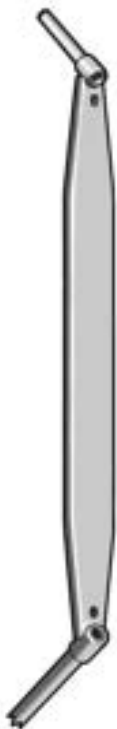

DOUBLE DRILL SLEEVE

3.5mm/2.5mm
OM 47-0972
for 2.5mm and
3.5mm drill bits
and tap for 3.5mm
cortical screws
and tap for 4.0mm
cancellous screws



DOUBLE DRILL SLEEVE

4.5mm/3.2mm
OM 47-0967
for 3.2mm and
4.5mm drill bits
and tap for 4.5mm
cortical screws
and tap for 4.5mm
malleolar (shaft) screws



DOUBLE DRILL SLEEVE

6.5mm/3.2mm
OM 47-0965
for 3.2mm drill bits
and taps for 6.5mm
cancellous screws



PARALLEL DRILL GUIDE AND DRILL SLEEVE

2.0mm
OM 47-0970
three holes and one hole for 2.0mm drill bits



UNIVERSAL DRILL GUIDE 3.5mm

OM 48-0004
for 3.5mm cortical screws and 3.5mm malleolar (shaft) screws and 2.5mm drill bits. Can be used as neutral/load drill guide.

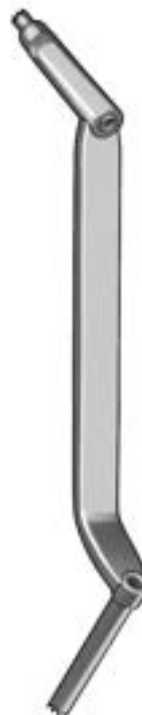

UNIVERSAL DRILL GUIDE 4.5mm

OM 47-0985
for 4.5mm cortical screws and 4.5mm malleolar (shaft) screws and 3.2mm drill bits. Can be used as neutral/load drill guide.



Also can be used as 3.2mm drill bit guide.

TAP SLEEVE

OM 47-0971
4 1/2" (114mm)
for 3.2mm drill bits



INSERT DRILL SLEEVE

3.5mm/2.7mm
OM 47-0974
for 2.5mm drill bits and for long 3.5mm lag screws



INSERT DRILL SLEEVES

4.5mm/3.2mm
OM 47-0973
for 3.2mm drill bits and for 4.5mm lag screws



TAP SLEEVE

OM 47-0969
5" (127mm)
with toothed tip and tissue
protector sleeve for 4.5mm tap



POINTED DRILL GUIDE

OM 47-0975
6" (152mm)
for 4.5mm cortical screws



DRILL SLEEVE

OM 47-0976
4 1/2" (114mm)
with 40mm long tip
for 3.2mm drill bits
for round hole and
semi-tubular plates



DRILL SLEEVE

OM 47-0982
5" (127mm)
with 60mm long tip
for 3.2mm drill bits
for round hole plates



Drill guide ends are color coded.
green = neutral
gold = load

DRILL GUIDE

2.0mm neutral and load end
OM 47-0977
4 3/4" (121mm)
for 2.0mm drill bit
for 2.7mm cortical screw



DRILL GUIDE

2.5mm neutral and load end
OM 47-0978
5 1/2" (140mm)
for 2.5mm drill bit
for 3.5mm cortical screw



DRILL GUIDE

3.2mm neutral and load end
OM 47-0980
6 1/2" (165mm)
for 3.2mm malleolar (shaft) drill bit
for 4.5mm cortical screw

SCREWDRIVERS

Note: Screwdrivers: used to place and remove bone screws.



MINI HEXAGONAL SCREWDRIVER

OM 47-0950
2 1/4" (57mm), 1.5mm
quick coupling end
sleeve included

OM 47-0959
screw holding
sleeve only



MINI CRUCIFORM SCREWDRIVER BIT

OM 45-0004
2 1/2" (64mm)
quick coupling end

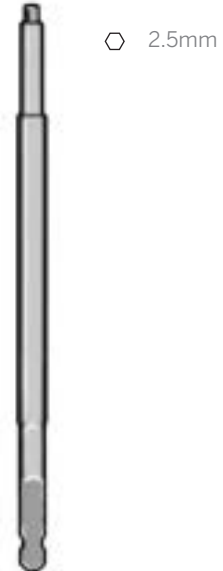

SMALL HEXAGONAL SCREWDRIVER

OM 47-0953
4" (102mm), 2.5mm
quick coupling end

OM 47-0955
screw holding
sleeve only
for OM 47-0953



HEXAGONAL SCREWDRIVER SHAFT

OM 48-0348
5 1/2" (140mm), 2.5mm
quick coupling end
with notch

OM 48-0365
sleeve only



HEXAGONAL SCREWDRIVER SHAFT (PELVIC)

OM 47-0951
6 1/2" (165mm), 2.5mm
quick coupling end
with notch

OM 48-0365
sleeve only



LARGE HEXAGONAL SCREWDRIVER

OM 47-0954
4 1/2" (114mm), 3.5mm
quick coupling end



3.5mm

HEXAGONAL SCREWDRIVER SHAFT (PELVIC)

OM 47-0961 OM 47-0983
 6 1/2" (165mm), 3.5mm sleeve only
 quick coupling end
 with notch



3.5mm

STAR DRIVE SCREWDRIVER SHAFT

OM SYN 314467 T8 QC Self retain 105mm
 OM SYN 314116 T15 QC Self retain 100mm
 OM SYN 314119 T25 QC Self retain 165mm



This is the sleeve for
 OM 48-0349
 OM 48-0353
 OM 47-0961

SCREWDRIVER SLEEVE

OM 47-0983
 5" (127mm)



This is the sleeve for
 OM 47-0951
 OM 48-0364
 OM 48-0368
 OM 48-0348

SCREWDRIVER SLEEVE

OM 48-0365
 3" (76mm)

SCREWDRIVERS

Refer to chart on page T1 and T2 for Master Guide, Screws, Drill Bits, Taps, Instruments



**HEXAGONAL
SCREWDRIVER**

OM 48-0670
7 5/8" (194mm) 1.5mm



**HEXAGONAL
SCREWDRIVER**

OM 47-0952
7 3/4" (197mm), 2.5mm
screwdriver with sleeve

OM 47-0955
screw holding
sleeve only
for OM 47-0952

OM 47-0956
screwdriver only
for OM 47-0952



**CRUCIFORM
SCREWDRIVER**

OM 47-0957
7 1/2" (191mm), 1.5 / 2.5mm
screwdriver with sleeve

OM 47-0959
screw holding
sleeve only
for OM 47-0957

OM 47-0958
screwdriver only
for OM 47-0957



STAR DRIVER

OM 96-0164
9" (228mm)
silicone handle
fits 3.5/4.0mm screws



HEXAGONAL SCREWDRIVER

OM 48-0368
8" (203mm)
2.5mm with notch
screwdriver only

OM 48-0365
sleeve only



**HEXAGONAL SCREWDRIVER
(PELVIC)**

OM 48-0364
10 1/2" (267mm)
2.5mm with notch
screwdriver only

OM 48-0365
sleeve only



Phenolic handles
is autoclavable to
290°F (143°C)

SINGLE SLOT SCREWDRIVER

OM 48-0355
6 3/4" (172mm)
with phenolic handle

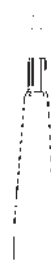

OM 48-0350
2.5mm hexagonal



OM 48-0352
3.5mm hexagonal



OM 48-0354
single slot

Phenolic handles
is autoclavable to
290°F (143°C)



OM 48-0356
cruciform



OM 48-0358
Phillips

SCREWDRIVER

10" (254mm) with phenolic handle



 3.5mm



HEXAGONAL SCREWDRIVER

OM 48-0349
10" (254mm), 3.5mm with notch



 3.5mm



HEXAGONAL SCREWDRIVER (PELVIC)

OM 48-0353
12" (305mm), 3.5mm with notch



SCREWDRIVER SET (A/O CONNECTION)

OM 48-0481
complete set with sterilization case

OM 48-0482
sterilization case only
8 1/2" X 4 1/4" X 2"
(216mm X 114mm X 51mm)



SCREWDRIVER HANDLE

OM 48-0483
5 1/2" (140mm) with key
cannulation 1/4" (6.3mm)
Allows K-Wire and pins to be inserted
with Jacobs chuck OM 48-0478.



OM 48-0484
5 1/2" (140mm)
single slot



OM 48-0485
5 1/2" (140mm)
cruciform



JACOBS UNIVERSAL CHUCK

OM 48-0488
3" with key
cannulation 1/4" (6.3mm)
Allows K-Wire and pins to be inserted
with Jacobs chuck.



OM 48-0486
5 1/2" (140mm)
Phillips



OM 48-0487
5 1/2" (140mm)
small Phillips



3.5mm



OM 48-0489
5 1/2" (140mm)
3.5mm hexagonal



2.5mm



OM 48-0490
5 1/2" (140mm)
2.5mm hexagonal



To check fracture and
remove ingrown tissue.

SHARP HOOK

OM 47-0880
6" (152mm)



To hold all sizes of
OrthoMed bone screws.

**SELF RETAINING
SCREW HOLDING FORCEPS**

OM 47-0930
3 1/2" (89mm)



**SELF RETAINING
SCREW HOLDING FORCEPS**

OM 45-0208 for 1.5mm to 2.7mm screws
OM 45-0210 for 3.5mm to 6.5mm screws



PLATE HOLDING CLIP

OM 47-0962 2.0mm
OM 47-0963 2.7mm
OM 47-0964 3.5mm



**DRILL SLEEVE
FOR TENSION DEVICE**

OM 47-0909
2" (51mm)
span: 8mm / 16mm
for 3.2mm drill bit



TENSION DEVICE

OM 47-0910
2 1/2" (64mm)
span: 8mm



For standard
and small plates

**TENSION DEVICE
ARTICULATED**

OM 47-0911
3 1/2" (89mm)
span: 20mm

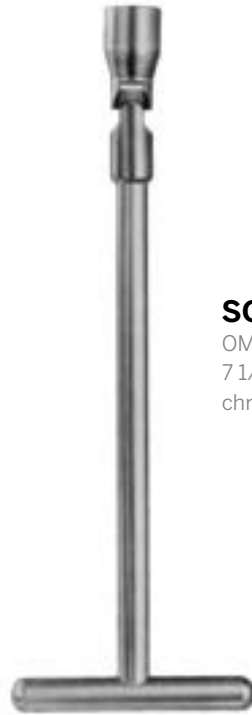

SOCKET WRENCH

OM 47-0912
7 1/2" (191mm), 11mm
chrome vanadium



For tightening
8mm nuts.

WRENCH

OM 47-0914
5" (127mm)

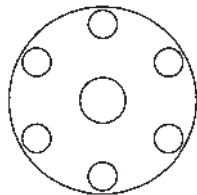
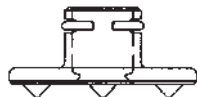

SPIKED DISC

OM 47-0921



BALL SPIKE

Straight
OM 47-0906
12" (305mm)



COMBINATION WRENCHES

		Overall Length
OM 85-0006	6mm	3 1/2"
OM 85-0008	8mm	4 1/2"
OM 85-0010	10mm	5 1/2"
OM 85-0012	11mm	6"
OM 85-0014	12mm	7"
OM 85-0016	13mm	7"
OM 85-0018	14mm	7 3/4"
OM 85-0020	15mm	8 1/2"
OM 85-0022	1/4" (6mm)	3 1/2"
OM 85-0024	5/16" (8mm)	4 1/2"
OM 85-0026	3/8" (10mm)	5 1/2"
OM 85-0028	7/16" (11mm)	6"
OM 85-0030	1/2" (13mm)	7"
OM 85-0032	9/16" (14mm)	7 3/4"
OM 85-0034	5/8" (16mm)	8 1/2"

OPEN END WRENCHES

Stainless steel

		Overall Length
OM 85-0036	6x7mm	4 7/8" (125mm)
OM 85-0038	8x9mm	5 1/2" (141mm)
OM 85-0040	10x11mm	6 1/4" (159mm)
OM 85-0042	12x13mm	7" (178mm)
OM 85-0044	14x15mm	7 1/2" (192mm)
OM 85-0046	16x17mm	8 1/4" (210mm)
OM 85-0048	19x22mm	9 1/2" (243mm)
OM 85-0050	24x27mm	10 1/2" (267mm)
OM 85-0052	28x29mm	10 7/16" (265mm)
OM 85-0054	30x32mm	9 9/16" (246mm)
OM 85-0056	19x24mm	11 3/8" (288mm)
OM 85-0058	1/4"x5/16" (6mmx24mm)	4 7/8" (125mm)
OM 85-0060	3/8"x7/16" (10mmx11mm)	6 1/4" (159mm)
OM 85-0062	1/2"x9/16" (13mmx14mm)	7" (178mm)
OM 85-0064	5/8"x11/16" (16mmx18mm)	8 1/4" (210mm)
OM 85-0066	3/4"x13/16" (19mmx21mm)	8 7/8" (225mm)
OM 85-0068	7/8"x15/16" (22mmx24mm)	10 1/4" (261mm)
OM 85-0070	1"x1 1/16" (25mmx27mm)	10 3/8" (264mm)
OM 85-0072	1 1/8"x1 1/4" (29mmx32mm)	10 5/8" (270mm)

Stainless Steel designed for repeated autoclaving over years of use.

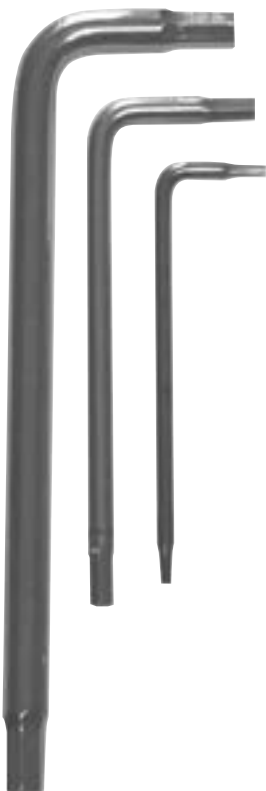

HEX KEYS

Stainless Steel, inch sizes, L Pattern, standard length

OM 85-0200	1/16"
OM 85-0205	5/64"
OM 85-0210	3/32"
OM 85-0215	7/64"
OM 85-0220	1/8"
OM 85-0225	9/64"
OM 85-0230	5/32"
OM 85-0235	3/16"
OM 85-0240	7/32"
OM 85-0245	1/4"
OM 85-0250	5/16"
OM 85-0255	3/8"

OM 85-0260
10 Piece Set (includes one of each of 1/16"-1/4")

OM 85-0265
12 Piece Set (includes one of each)

HEX KEYS

Stainless Steel, metric sizes, L pattern, standard length

OM 85-0270	1.5mm
OM 85-0275	2.0mm
OM 85-0280	2.5mm
OM 85-0285	3.0mm
OM 85-0290	3.5mm
OM 85-0295	4.0mm
OM 85-0300	4.5mm
OM 85-0305	5.0mm
OM 85-0310	6.0mm
OM 85-0315	8.0mm
OM 85-0320	10.0mm

OM 85-0325
9 Piece Set (includes one of each of 1.5mm-6.0mm)

OM 85-0330
11 Piece Set (includes one of each)

BENDING TEMPLATES

BENDING TEMPLATES

Anodized aluminum
Color-coded



OM 47-0944 2 1/2" for small plates



OM 47-0945 3 1/2" for small plates

To simulate required
plate bending.



OM 47-0941 3 1/2" 5 holes



OM 47-0942 4 1/2" 7 holes



OM 47-0943 6" 9 holes

BENDING TEMPLATES

Anodized aluminum



OM 45-0126 2 1/2" 5 holes 3.5mm



OM 45-0127 3 1/2" 7 holes 3.5mm



OM 45-0128 4 1/2" 9 holes 3.5mm



OM 45-0129 6" 12 holes 3.5mm



OM 45-0118 3 1/4" 5 holes 4.5mm



OM 45-0120 4 3/4" 7 holes 4.5mm



OM 45-0122 6" 9 holes 4.5mm



OM 45-0124 8" 12 holes 4.5mm

BENDING TEMPLATES

Anodized aluminum
Reconstruction plates



OM 47-0946
22 holes
8" (203mm) length X 2 1/2" (64mm) height
3.5mm



OM 47-0947
22 holes
10 1/2" (267mm) straight
3.5mm



OM 47-0948
16 holes
10" (254mm) straight
4.5mm

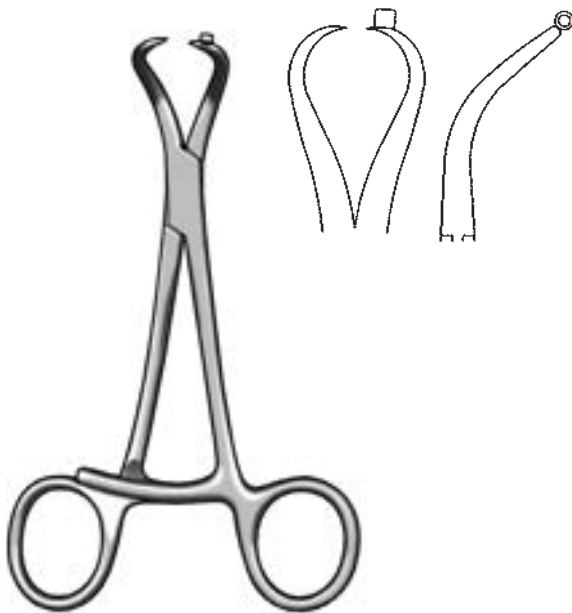

BONE HOLDING FORCEPS

OM 45-0304
5 1/2" (140mm)
with 1.6mm drill guide

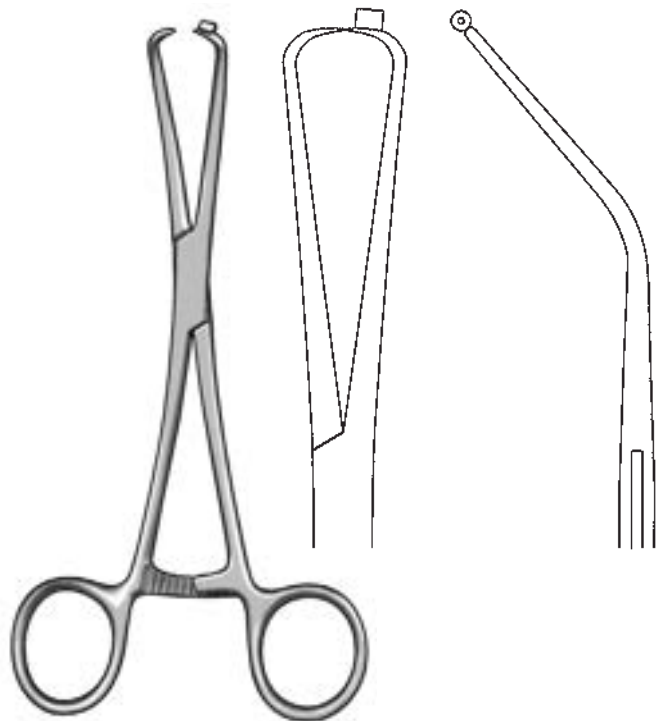

BONE HOLDING FORCEPS

OM 45-0302
6 3/4" (171mm)
with 0.9mm drill guide



For positioning small bone plates.

PLATE AND BONE HOLDING FORCEPS

OM 47-0138 4¾" (121mm)

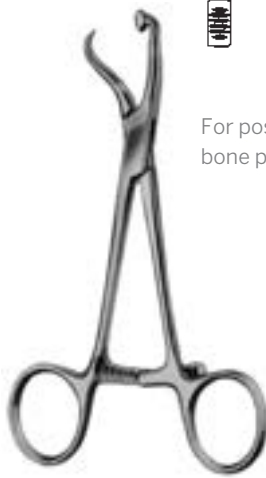

For positioning mini bone plates.

PLATE AND BONE HOLDING

OM 47-0139 4¾" (121mm)
1 pointed tip

One tip has a stepped point for better hold on bone.

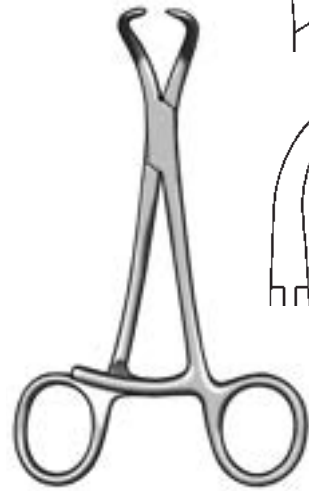

BONE REDUCTION FORCEPS

OM 47-0137
5¼" (133mm) curved

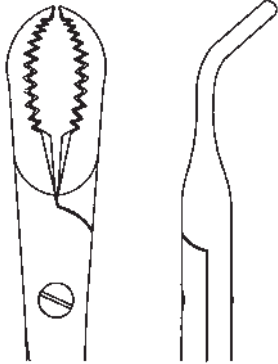
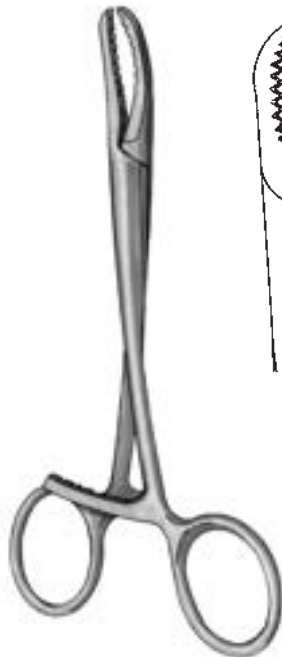

BONE REDUCTION FORCEPS

OM 47-0128
5½" (140mm) small
curved
ratchet length: 11/8"

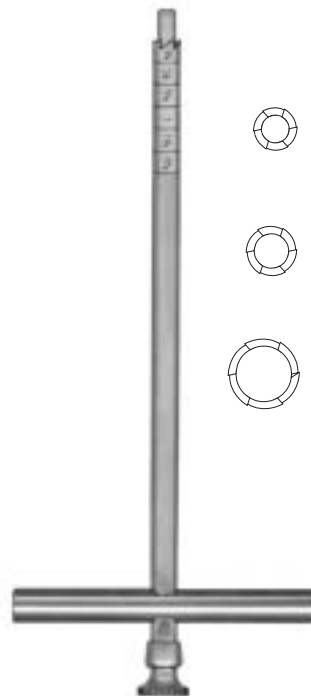

i.d. = inside diameter
o.d. = outside diameter

small
3mm i.d / 5mm o.d.

medium
4mm i.d / 5mm o.d.

large
6mm i.d / 8mm o.d.

Designed for bone biopsy. Also facilitates removal of broken bone screws.

MICHELE TREPHINE

OM 48-0239 small
OM 48-0240 medium
OM 48-0241 large

Note: Bending instruments: To avoid weakening of plates, do not bend or twist sharply. Never reverse bend or bend or twist at a plate hole.



MINI PLATE BENDING IRON

OM 47-0917
 4 3/4" (121mm)
 for mini and finger plates



OM 47-0916



OM 47-0915

SMALL PLATE BENDING IRONS

5 1/2" (140mm)
 for 2.7mm and 3.5mm plates

Used in pairs.



STANDARD PLATE BENDING IRON

OM 47-0918
 9 1/2" (241mm)
 for standard plates with 4 holes



PLATE BENDING IRON

OM 47-0919
 for 3.5mm and 4.5mm plates

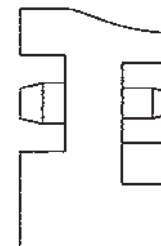



MINI PLATE BENDING PLIERS

OM 48-0244
5" (127mm)
for 1.5mm and 2.0mm plates

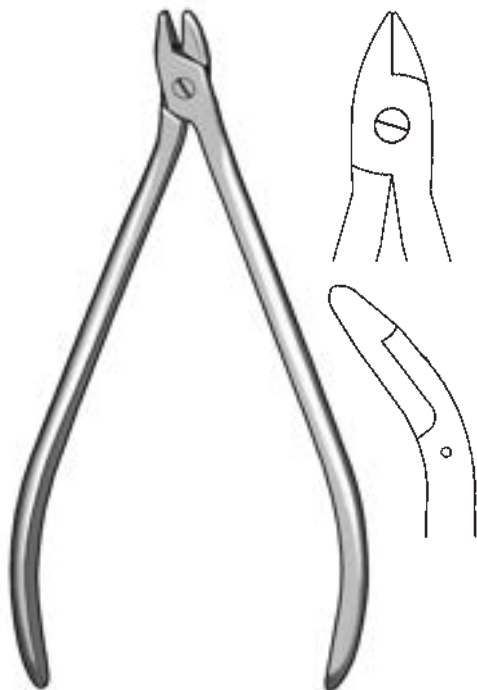

BENDING PLIERS

OM 47-0931
5 1/2" (140mm)
for 1.5mm and 2.0mm plates

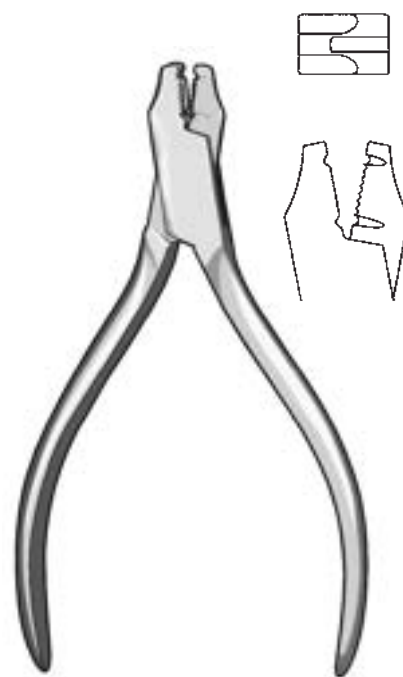

BENDING PLIERS

OM 49-0724
Bends mini plates and up to 1.1mm (.045") K-Wire to 90° angle



SMALL PLATE BENDING PLIERS

OM 47-0925
8 3/4" (222mm)
for 2.7mm and 3.5mm plates

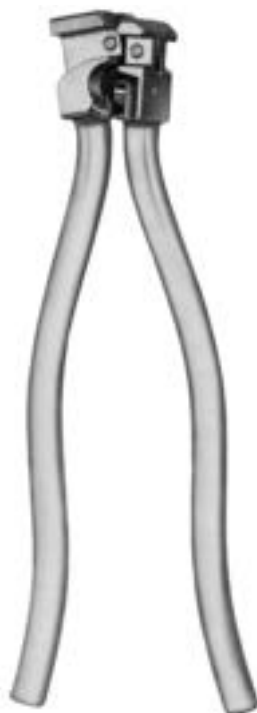

PLATE BENDING PLIERS

OM 47-0927
10" (254mm)
for reconstruction plates



PLATE BENDING PLIERS

OM 47-0928
10" (254mm)
includes two anvils for narrow and broad plates

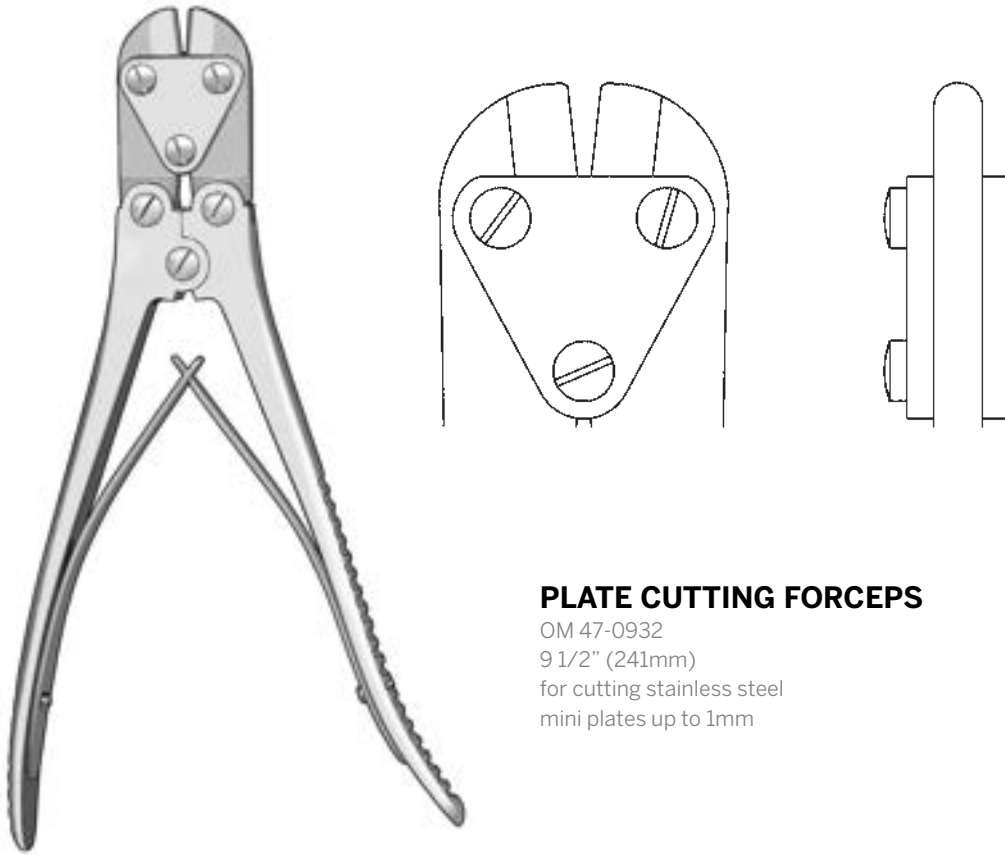

PLATE CUTTING FORCEPS

OM 47-0932
9 1/2" (241mm)
for cutting stainless steel
mini plates up to 1mm

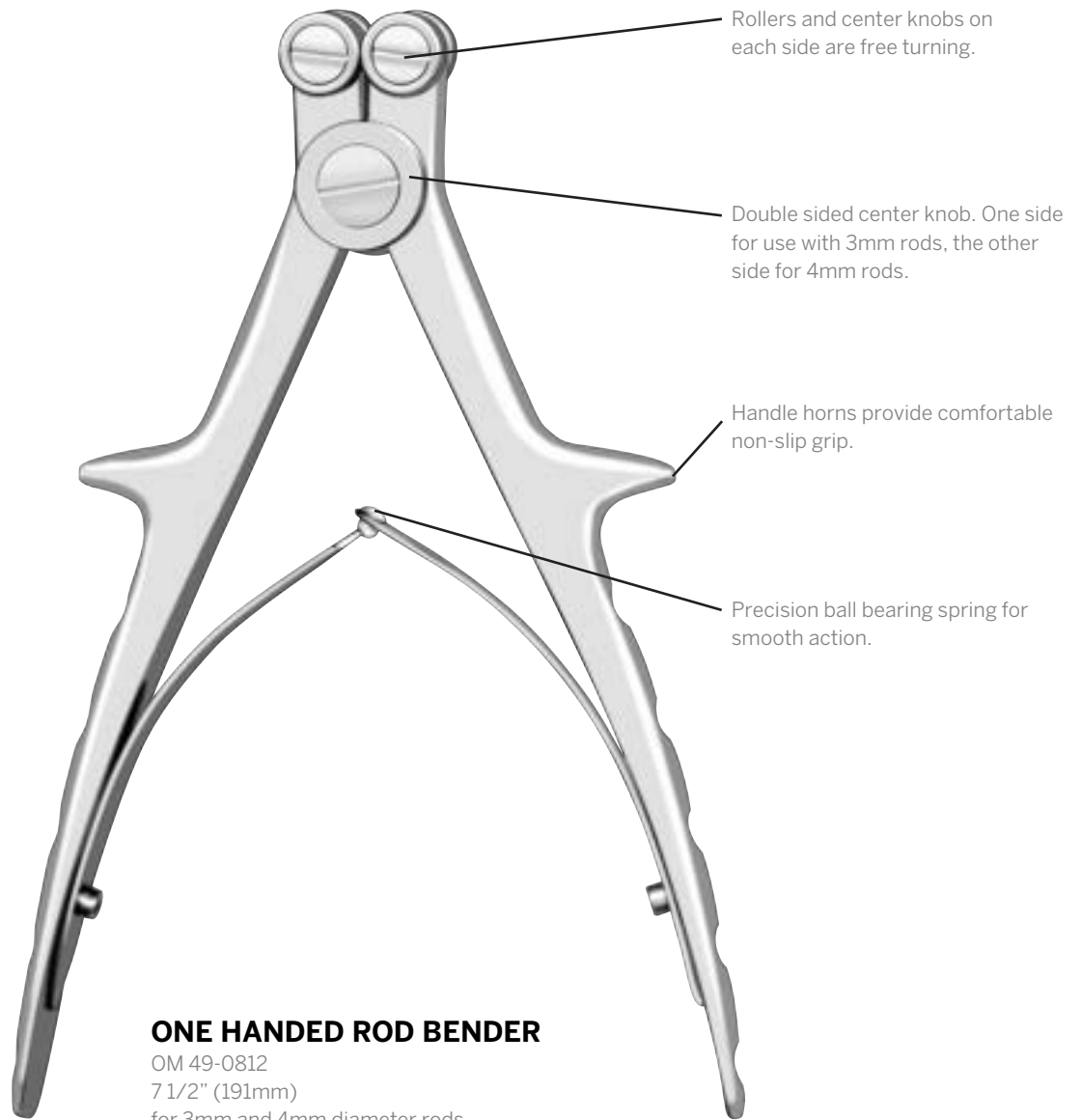
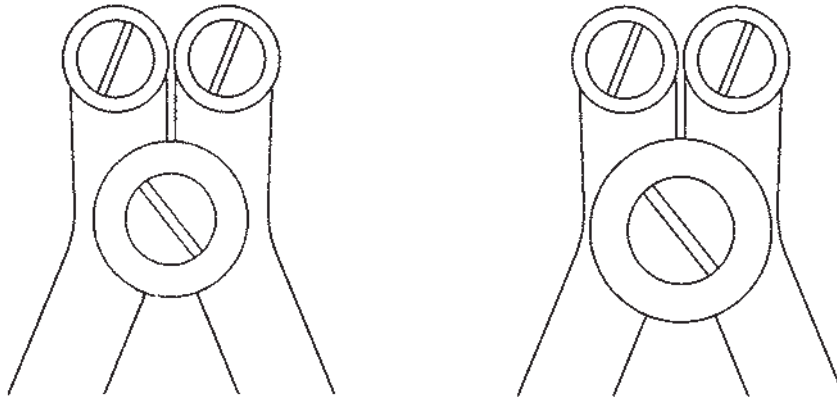

PLATE BENDING PRESS

OM 47-0929
17" (305mm)

ROD BENDING INSTRUMENTS

Note: One-handed rod bender: Easily bends 3mm and 4mm rods.



Note: Universal Rod Bender: Bends any size rod (up to 7mm) to three different angles without using a separate reduction ring.

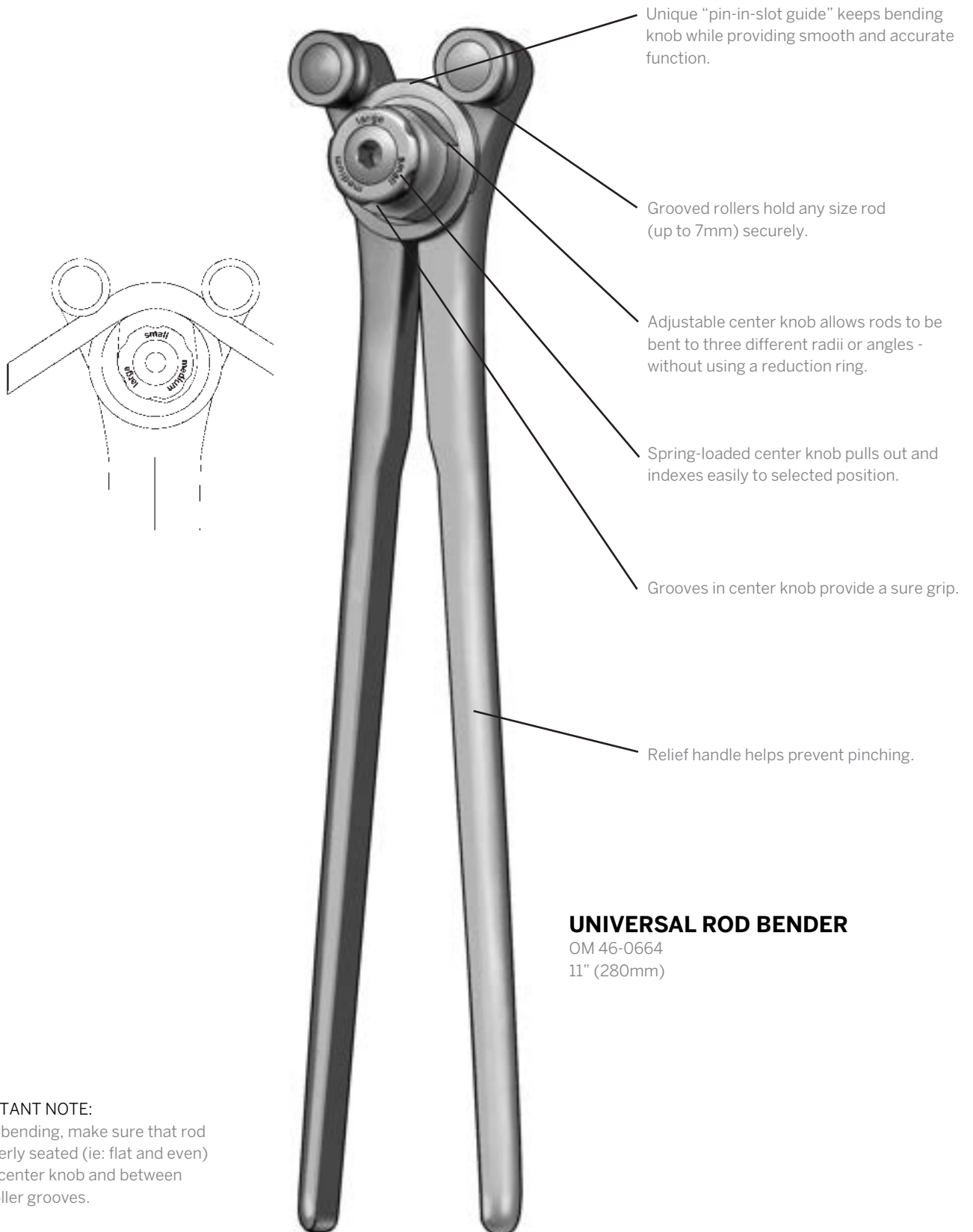

UNIVERSAL ROD BENDER

OM 46-0664
11" (280mm)

IMPORTANT NOTE:

Before bending, make sure that rod is properly seated (ie: flat and even) on the center knob and between both roller grooves.



SCREW EXTRACTION SET

OM 87-0000
Complete

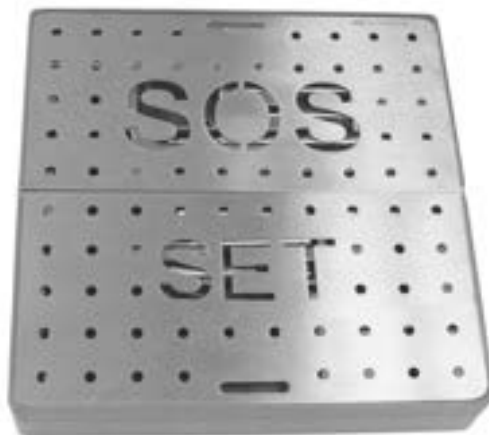

TRAY (EMPTY)

OM 87-0005



LISTING FOR SET: OM 87-0000 SCREW-EXTRACTION - SET COMPLETE

Reference Number	Product - Description	
OM 87-0005	AL-Tray for Screw Extraction OM 87-0005	1Pcs.
OM 87-0010	Conical Extraction Screw for 1.5 / 2.0mm Screws	1Pcs.
OM 87-0015	Conical Extraction Screw for 2.7 / 3.5 / 4.0mm Screws	1Pcs.
OM 87-0020	Conical Extraction Screw for 4.5 / 5.0 / 6.5 / 7.0mm Screws	1Pcs.
OM 87-0030	Extraction Bolt for 1.5mm Screws	1Pcs.
OM 87-0035	Extraction Bolt for 2.0mm Screws	1Pcs.
OM 87-0038	Extraction Bolt for 2.7mm Screws	1Pcs.
OM 87-0040	Extraction Bolt for 3.5 / 4.0mm Screws	1Pcs.
OM 87-0043	Extraction Bolt for 4.5mm Screws	1Pcs.
OM 87-0045	Extraction Bolt for 5.0 / 6.5 / 7.0mm Screws	1Pcs.
OM 87-0050	Hollow Reamer for 1.5mm Screws	1Pcs.
OM 87-0052	Hollow Reamer for 2.0mm Screws	1Pcs.
OM 87-0054	Hollow Reamer for 2.7mm Screws	1Pcs.
OM 87-0056	Hollow Reamer for 3.5 / 4.0mm Screws	1Pcs.
OM 87-0058	Hollow Reamer for 4.5mm Screws	1Pcs.
OM 87-0059	Hollow Reamer for 5.0 / 6.5 / 7.0mm Screws	1Pcs.
OM 87-0064	Spare Reamer (Reamer Tube) for Hollow Reamer 1.5mm (used for 1.5mm Screws)	1Pcs.
OM 87-0065	Spare Reamer (Reamer Tube) for Hollow Reamer 2.0mm (used for 2.0mm Screws)	1Pcs.
OM 87-0066	Spare Reamer (Reamer Tube) for Hollow Reamer 2.7mm (used for 2.7mm Screws)	1Pcs.
OM 87-0067	Spare Reamer (Reamer Tube) for Hollow Reamer 3.5 / 4.0mm (used for 3.5 / 4.0mm Screws)	1Pcs.
OM 87-0069	Spare Reamer (Reamer Tube) for Hollow Reamer 4.5mm (used for 4.5mm Screws)	1Pcs.
OM 87-0071	Spare Reamer (Reamer Tube) for Hollow Reamer 5.0 / 6.5 / 7.0mm (used for 5.0 / 6.5 / 7.0mm Screws)	1Pcs.
OM 47-0880	Sharp Hook, Length 155mm	1Pcs.
OM 49-0272	Mini Lexer Gouge, 4mm	1Pcs.
OM 49-0274	Mini Lexer Gouge, 6mm	1Pcs.
OM 49-0277	Mini Lexer Gouge, 10mm	1Pcs.
OM 87-0080	Screw Holding Forceps 20.5cm / 8"	1Pcs.
OM 47-0960L	T-Handle, Large with AO-Quickcoupling Length 160mm	1Pcs.
OM 87-0090	Template for use Broken Screw-Extraction Instruments (Guide Manual for Use)	1Pcs.

MEASURING DEVICES



SECTION W



To determine dimensions during surgery.

CONTENTS

Screw Depth Gauge	1
Calipers	1-2
Rulers	3
Easy Clean Depth Gauge	4



TOWNLEY CALIPER

OM 48-0314
 4" (102mm)
 takes inside and outside measurements up to 4" (10cm)

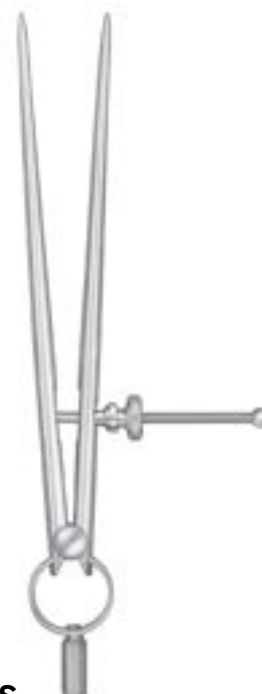

BONE COMPASS

OM 48-0302
 8" (203mm)

Used to determine screw length required during internal fracture fixation (mm graduated). Gauges snap apart for easy cleaning.



MINI SCREW DEPTH GAUGE

OM 47-0934
 4 3/4" (121mm)
 up to 30mm



SMALL SCREW DEPTH GAUGE

OM 47-0936
 6 1/4" (159mm)
 up to 50mm



LARGE SCREW DEPTH GAUGE

OM 47-0940
 8 3/4" (222mm)
 up to 100mm



X-LARGE SCREW DEPTH GAUGE

OM 47-0935
 11" (279mm)
 up to 120mm



CASTROVIEJO CALIPER

OM 53-0040
3 1/2" (89mm)
graduated to 20mm
for hand surgery



CASTROVIEJO CALIPER

OM 53-0042
6 1/2" (165mm)
graduated to 40mm



POLK FINGER GONIOMETER

OM 48-0310
6" (152mm)
cm and inch graduated

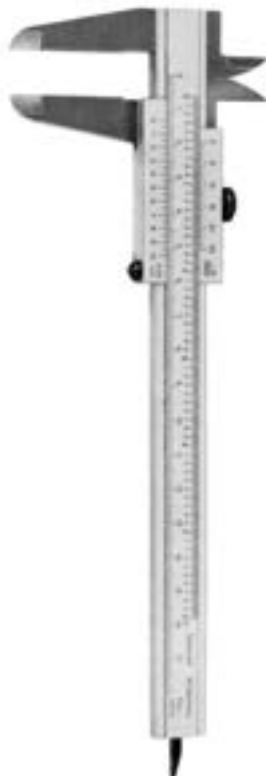

ALUMINUM CALIPER

OM 48-0312
9 1/8" (232mm)
inch and mm graduated
up to 6" (180mm)
inside and outside measuring
faces and depth bar

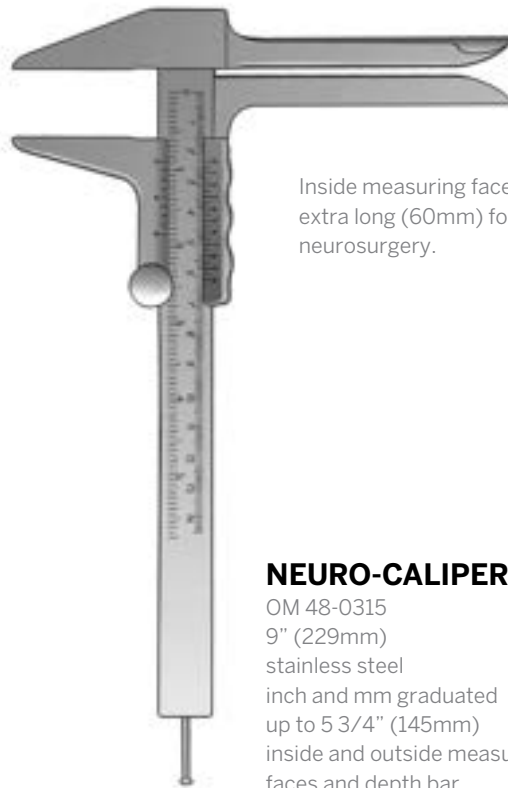

Inside measuring faced
extra long (60mm) for
neurosurgery.

NEURO-CALIPER

OM 48-0315
9" (229mm)
stainless steel
inch and mm graduated
up to 5 3/4" (145mm)
inside and outside measuring
faces and depth bar



OM 39-0692 6" (152mm)
 OM 39-0694 8" (203mm)
 OM 39-0698 12" (305mm)
 OM 39-0700 20" (508mm)

RULER

flexible
 inch and mm graduated

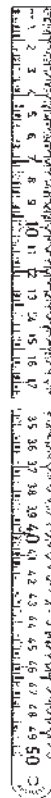

Ruler for x-rays.

X-RAY SCALE

OM 48-0299
 50cm length
 mm graduated



MEASURING TAPE

OM 48-0313
 linen, inch and
 cm graduated
 up to 150cm

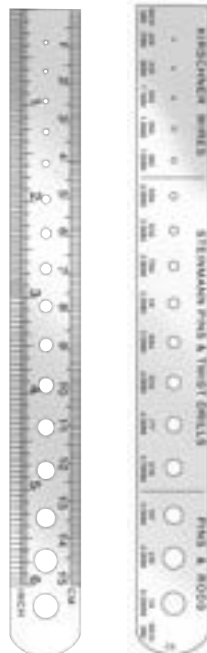

Front Back

Reverse side has handy gauge to
 measure K-Wires, Steinmann Pins,
 twist drills, and pins and rods.

Note:

Gauge Measures
 K-Wires .028"-.062"
 .7mm-1.6mm
 Pins 5/64"-3/16"
 2.0mm-4.76mm
 Rods .197"-1/4"
 5.0mm-6.35mm

K-Wire RULER & PIN GAUGE

OM 39-0710
 6" (152mm)
 inch and mm graduated



EASY CLEAN DEPTH GAUGE

	Screw Size	Hook Probe	Measuring Range
OM 24-0116	1.2-1.5mm	0.8mm	0-30mm
OM 24-0118	2.0-2.4mm	1.2mm	0-30mm
OM 24-0120	2.0-2.4mm	1.2mm	0-50mm
OM 24-0124	2.7mm	1.7mm	0-50mm
OM 24-0128	3.5-4.0mm	2.2mm	0-50mm
OM 24-0130	3.5-4.0mm	2.2mm	0-80mm

MIS INSTRUMENTS



SECTION X



Minimally invasive instruments to reduce soft tissue trauma.

CONTENTS

Collateral Retractors	1
Tribal Retractor	1
“Z” Retractors	2
PCL Retractor	3-4
Soft Tissue Retractors	3
Patella Protector	3
Bent Hohmanns	4

ORTHO+MED
The Surgical Instrument Specialists



POSTERIOR COLLATERAL RETRACTOR

- OM 82-0010 8" (203mm) small
- OM 82-0015 8 1/2" (216mm) medium
- OM 82-0020 9" (229mm) large



COLLATERAL RETRACTOR

- OM 82-0025
- 8" (203mm) length



TIBIAL RETRACTOR

- OM 82-0030
- 7 3/4" (197mm) length



DOANE KNEE RETRACTOR

6" (152mm) a.k.a. "Z" Retractor

OM 48-0180
57mm blades, 69mm deep, 11mm wide

OM 48-0184
63mm blades, 76mm deep, 11mm wide

OM 82-0045
Overall length of retractor is 8.5" (216mm)
Overall length of each blade is 2.934" (75mm)
Small blade width is .375" (10mm)
Standard blade width is .5" (13mm)



OM 82-0050
Overall length of retractor is 8.5" (216mm)
Overall length of each blade is 2.5" (64mm)
Large blade length is 3.2" and width is .75" (19mm)
Standard blade length is 2.934" and width is .5" (13mm)



EXTENDED DUAL WIDTH "Z" RETRACTOR

OM 82-0045 small
OM 82-0050 standard



PCL RETRACTOR
OM 82-0055
10 1/2" (267mm) length



COLLATERAL SOFT TISSUE RETRACTOR
OM 82-0060
9 1/8" (232mm) length



TIBIAL RETRACTOR
OM 82-0034
9" (229mm) 3 hole



RESECTED PATELLA PROTECTOR
OM 82-0075
3 1/2" (83mm) length



11mm

Designed to straddle the cruciate ligament.

PCL RETRACTOR

OM 90-2820
10" (254mm)



TIBIAL RETRACTOR

OM 82-0031
10 1/4" (260mm)



BENT HOHMANN

OM 90-7110
11" (280mm) right angle
20mm blade



**RIGHT ANGLE HOHMANN
RETRACTOR LONG**

OM 86-0120L
12 1/2" (318mm) right angle
18mm blade width

STERILE PROCESSING CONTAINERS AND BRUSHES



SECTION Y



Trays, brushes and accessories to aid in cleaning, protection and transport of instruments.

CONTENTS

Sterilization Trays/Containers	1-2
Cleaning Brushes	4-5
Instrument Trays	6-7
Mixing Solution Bowls	8
Medicine and Iodine Cups	8
Instrument Stringers	9
Instrument Identification	10
Instrument Protectors	11
Mesh Baskets	12
Debridement Pan	13

ORTHO+MED
The Surgical Instrument Specialists

Micro Tray with silicone cushion on the top and spiked silicone strips on the bottom, hold instruments gently yet snugly in place.



MICRO TRAY

With silicone mat strips

OM 81-0195	8 1/2" w x 8" l x 1 1/8" h	(216mm w x 203mm l x 29mm h)
OM 81-0200	8 1/2" w x 9" l x 1 1/8" h	(216mm w x 229mm l x 29mm h)
OM 81-0205	8 1/2" w x 12 1/2" l x 1 1/8" h	(216mm w x 318mm l x 29mm h)
OM 81-0210	8 1/2" w x 14 3/4" l x 1 1/8" h	(216mm w x 375mm l x 29mm h)
OM 81-0215	10 1/2" w x 6" l x 1 1/8" h	(267mm w x 152mm l x 29mm h)
OM 81-0220	10 1/2" w x 10" l x 1 1/8" h	(267mm w x 254mm l x 29mm h)
OM 81-0225	10 1/2" w x 15" l x 1 1/8" h	(267mm w x 381mm l x 29mm h)
OM 81-0230	10 1/2" w x 20" l x 2 1/2" h	(267mm w x 508mm l x 64mm h)
OM 81-0235	10 1/2" w x 20" l x 1 1/8" h	(267mm w x 508mm l x 29mm h)

Note: Customization of trays and additional sizes are available upon request.

STERILIZATION TRAYS

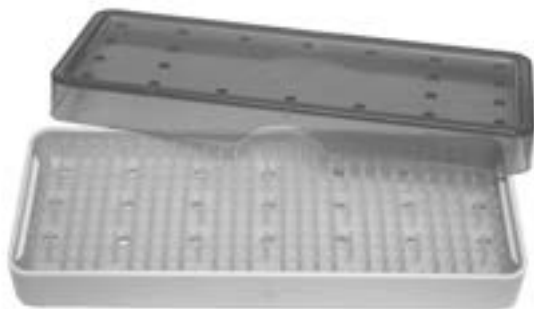

These trays are rugged enough to last for many years, yet gentle on delicate instruments. They cool down in 60 seconds after flash sterilization. Lightweight tool Sterilize and transport tools safely and easily. Convenient see-through lid allows you to inventory contents. FDA-approved soft mats come with each tray to prevent shifting of instruments. Mats retain their flexibility even after repeated sterilization at high temperatures. All trays withstand harsh rigors of steam autoclave, dry heat, or flash up to 320°F, 160°C, Eto, gas plasma, gamma radiation, hydrogen peroxide, cold sterilants, disinfectants, or germicides.

UNIVERSAL STERILIZATION TRAYS

OM 81-0290	3" w x 6" h shallow tray	2 1/2" w x 5 7/8" l x 3/4" h	(64mm w x 149mm l x 19mm h)
OM 81-0295	4" w x 8" h shallow tray	4" w x 7 1/2" l x 3/4" h	(102mm w x 191mm l x 19mm h)
OM 81-0300	7" w x 11" h deep tray	6 1/4" w x 10 1/2" l x 1 1/4" h	(159mm w x 267mm l x 32mm h)
OM 81-0305	11" w x 14" h shallow tray	11" w x 15" l x 3/4" h	(279mm w x 381mm l x 19mm h)
OM 81-0310	micro tray, base, lid, mat	2 1/2" w x 6" l x 1 1/4" h	(64mm w x 152mm l x 32mm h)
OM 81-0315	micro tray, base, lid, mat	2 1/2" w x 7 1/2" l x 3/4" h	(64mm w x 191 mm l x 19mm h)
OM 81-0320	micro tray, base, lid, mat	4" w x 6 1/2" l x 3/4" h	(102mm w x 165mm l x 19mm h)
OM 81-0325	micro tray, base, lid, mat	4" w x 7 1/2" l x 1 1/2" h	(102mm w x 191 mm l x 38mm h)
OM 81-0330	micro tray, base, lid, mat	6" w x 10" l x 3/4" h	(192mm w x 254mm l x 19mm h)
OM 81-0335	micro tray, base (deep), lid, mat	6" w x 10" l x 1 1/2" h	(152mm w x 254mm l x 38mm h)

Offers great protection for delicate scopes. Removable silicone bars fit any scope from 1mm to 10mm in diameter. All trays include base, lid, and mat.

These scope trays are designed to accommodate a variety of shapes and sizes. Safe for all standard sterilization methods including autoclave, steam, dry heat, and chemical. See-through lids offer easy identification. Silicone bars provide secure placement of scopes; the unique grid system allows versatility in scope placement and holds various sizes in one tray.



UNIVERSAL SCOPE AND LIGHT CABLE TRAY

OM 81-0240

Accommodates up to three 5mm to 10mm diameter scopes and a fiber-optic cable in one convenient tray. 8 1/4" w x 18 1/4" l x 2" h (210mm w x 464mm l x 51mm h). Includes base, lid, and bars.

SINGLE AND DOUBLE SCOPE TRAYS

OM 81-0245	single scope, med.	2 3/5" w x 16" l x 1" h	(66mm w x 406mm l x 25mm h)
OM 81-0250	double scope, med.	2 3/5" w x 16" l x 1" h	(66mm w x 406mm l x 25mm h)
OM 81-0255	cystoscope tray	3" w x 16 1/4" l x 1 1/2" h	(76mm w x 413mm l x 38mm h)
OM 81-0260	scope, tray, base, lid	2 3/5" w x 16" l x 1 1/2" h	(66mm w x 406mm l x 38mm h)
OM 81-0265	scope tray, base, lid, mat	2 3/5" w x 16" l x 1 1/2" h	(66mm w x 406mm l x 38mm h)
OM 81-0270	scope tray, base, lid	6 1/2" w x 18" l x 1 1/2" h	(165mm w x 457mm l x 38mm h)
OM 81-0275	scope tray, base, lid, mat	6 1/2" w x 18" l x 1 1/2" h	(165mm w x 457mm l x 38mm h)
OM 81-0280	scope tray, base, lid	6 1/2" w x 18" l x 3" h	(165mm w x 457mm l x 76mm h)
OM 81-0285	scope tray, base, lid, mat	6 1/2" w x 18" l x 3" h	(165mm w x 457mm l x 76mm h)

Note: Customization of trays and additional sizes are available upon request.

Baskets, filters, mats, indicator labels are also available for each container.

Available with or without bottom perforated.

Lids available in blue, red, yellow, green, black and steel colors.



STERILIZING CONTAINER

		Length	Width	Depth
OM 83-0600	Full size	585mm	280mm	100mm
OM 83-0605	Full size	585mm	280mm	135mm
OM 83-0616	Full size	585mm	280mm	150mm
OM 83-0630	Full size	585mm	280mm	260mm
OM 83-0700	¾ size	465mm	280mm	100mm
OM 83-0705	¾ size	465mm	280mm	135mm
OM 83-0716	¾ size	465mm	280mm	150mm
OM 83-0730	¾ size	465mm	280mm	260mm
OM 83-0800	½ size	299mm	280mm	100mm
OM 83-0805	½ size	299mm	280mm	135mm
OM 83-0816	½ size	299mm	280mm	150mm
OM 83-0830	½ size	299mm	280mm	260mm

Note: Customization of trays and additional sizes are available upon request.



**INSTRUMENT
CLEANING BRUSH**

7" (178mm)
OM 39-0682
wire
set of three

OM 39-0684
nylon
set of three



**DOUBLE-SIDED BRUSH
FOR INSTRUMENT CLEANING**

OM 39-0686
one side nylon, one side wire



OLIVE TIP PLUNGER BRUSH

OM QA ST10-1.5 10" (254mm) 1.5mm tip
OM QA ST10-2.5 10" (254mm) 2.5mm tip
OM QA ST7-2-9-2mm 7" (254mm) 2mm tip
OM QA ST10-3.0 10" (254mm) 3.00mm tip



Specially designed for aspirator tips and saliva ejectors. More effective than the conventional pipe cleaner, the white bristles are stiff enough to clean blood and debris away from inside walls in one or two sweeps. The stainless steel wire prevents rusting on sinks and countertops after use. Made 12" (305mm) long, this brush will extend the full length of aspirator tips and is flexible enough to round 45 and 90 degree curvatures.

CLEANING BRUSHES

Set of 1 dozen
OM QA XSB X-small
OM QA SCB Small
OM QA MCB Medium
OM QA LCB Large
OM QA XLCB X-large



SPECIALTY CLEANING BRUSHES

	Qty. per Pkg.	Brush Diameter	Length of Bristle Area	End to End Length
OM BR-3050	2	.062 (1/16")	1/2"	6"
OM BR-3100	2	.062 (1/16")	1/2"	18"
OM BR-3110	2	.700	1/2"	18"
OM BR-3125	2	.700	1/2"	24"
OM BR-3113	2	.079	1/2"	6"
OM BR-3114	2	.079	3/4"	12"
OM BR-3115	2	.080	1"	24"
OM BR-3120	2	.087	1/2"	18"
OM BR-3130	2	.105	1"	18"
OM BR-3137	2	.118	2 3/4"	12"
OM BR-3140	2	.125 (1/8")	2"	18"
OM BR-3142	2	.144	3/4"	8"
OM BR-3143	2	.158	3/4"	8"
OM BR-3144	2	.197	3"	16"
OM BR-3145	2	.200	2"	24"
OM BR-3150	2	.250 (1/4")	2"	18"
OM BR-3153	2	.276	3"	16"
OM BR-3155	2	.312 (5/16")	3"	24"
OM BR-3170	3	.375 (3/8")	1 1/2"	6"
OM BR-3173	2	.393	3"	16"
OM BR-3175	2	.440 (7/16")	3"	24"
OM BR-3160	2	.880 (7/8")	3 1/2"	18"
OM BR-3165	2	.880 (7/8")	4 1/4"	24"
OM BR-2300 Stainless Steel Brush	2	.438	2"	6"
OM BR-4100 Nylon Bristles, Fan End	2	.500 (1/2")	3"	18"
OM BR-4140 Nylon Brush is Centered on Stainless Steel Wire	6	.500 (1/2")	3"	24"



Wide assortment of heavy-duty, seamless trays have covered corners for easy sterilization. Covers have recessed strap handles for ease in handling and storing.

INSTRUMENT TRAYS AND FLAT/SOLID COVERS

OM PW-43	5 3/8 x 4 x 2 5/8	12-5.0 lbs.
OM PW-43-2	Cover - fits 43 tray	12-3.5 lbs.
OM PW-63	6 1/8 x 6 1/8 x 2 7/8	12-7.3 lbs.
OM PW-63-2	Cover - fits 63 tray	12-5.1 lbs.
OM PW-952	8 7/8 x 5 x 2	12-7.3 lbs.
OM PW-953	8 7/8 x 5 x 3	12-8.6 lbs.
OM PW-952-2	Cover - fits above two trays	12-5.8 lbs.
OM PW-1002	10 x 6 1/2 x 2	12-10.3 lbs.
OM PW-1002-2	Cover - fits 1002 tray	12-11.3 lbs.
OM PW-1202	12 1/4 x 7 3/4 x 2 1/4	12-16.0 lbs.
OM PW-1202-2	Cover - fits 1202 tray	12-11.3 lbs.
OM PW-E1082	10 x 8 1/4 x 2 1/2	6-7.2 lbs.
OM PW-E1084	10 x 8 1/4 x 4	6-8.5 lbs.
OM PW-E1082-2	Cover - fits above two trays	6-6.7 lbs.
OM PW-E1650	16 1/2 x 10 x 2 1/2	6-12.5 lbs.
OM PW-E1654	16 1/2 x 10 x 4	4-9.7 lbs.
OM PW-1650-2	Cover - fits above two trays	6-9.3 lbs.
OM PW-E902	6 7/8 x 4 1/4 x 2	12-6.0 lbs.
OM PW-904	6 7/8 x 4 1/4 x 4	12-8.1 lbs.
OM PW-902-2	Cover - fits above two trays	12-2.9 lbs.
OM PW-E2302	13 7/8 x 12 7/8 x 2 1/2	6-14.3 lbs.
OM PW-E2304	13 7/8 x 12 7/8 x 4	6-17.3 lbs.
OM PW-E2306	13 7/8 x 12 7/8 x 6	6-20.4 lbs.
OM PW-2302-2	Cover - fits above three trays	6-10.9 lbs.
OM PW-E06062	6 7/8 x 6 3/8 x 2 1/2	6-3.2 lbs.
OM PW-E06064	6 7/8 x 6 3/8 x 4	6-5.0 lbs.
OM PW-E06066	6 7/8 x 6 3/8 x 6	6-6.6 lbs.
OM PW-602-2	Cover - fits above three trays	6-2.4 lbs.
OM PW-E10062	10 3/8 x 6 3/8 x 2 1/2	6-5.3 lbs.
OM PW-E10064	10 3/8 x 6 3/8 x 4	6-7.5 lbs.
OM PW-E10066	10 3/8 x 6 3/8 x 6	6-9.5 lbs.
OM PW-402-2	Cover - fits above three trays	6-3.4 lbs.



Covered corners and large, open head which allow for easy handling, stacking and cleaning.

OBLONG INSTRUMENT/DRYING TRAYS

OM PW-10F	w/rolled bead	10"l x 6 1/2"w x 3/4"h	(254mm l x 165mm w x 19mm h)	6-3.5 lbs.
OM PW-13F	w/rolled bead	13 11/16"l x 9 13/16"w x 3/4"h	(348mm l x 249mm w x 19mm h)	6-9.9 lbs.
OM PW-15F	w/rolled bead	15 1/8"l x 10 5/8"w x 3/4"h	(384mm l x 270mm w x 19mm h)	6-10 lbs.
OM PW-17F	w/rolled bead	17"l x 11 5/8"w x 3/4"h	(432mm l x 295mm w x 19mm h)	6-12.5 lbs.
OM PW-19F	w/rolled bead	19 1/8"l x 12 5/8"w x 3/4"h	(486mm l x 321mm w x 19mm h)	6-14.5 lbs.
OM PW-1520	w/rolled bead	21 1/4"l x 16 1/4"w x 7/8"h	(540mm l x 413mm w x 22mm h)	6-22.8 lbs.
OM PW-1525	w/flat flange	25"l x 15"w x 5/8"h	(635mm l x 381mm w x 16mm h)	6-24.5 lbs.
OM PW-E12101		12 3/4"l x 10 3/8"w x 1 1/4"h	(324mm l x 264mm w x 32mm h)	6-6.9 lbs.
OM PW-E20121		20 3/4"l x 12 3/4"w x 1 1/4"h	(527mm l x 324mm w x 32mm h)	6-14.9 lbs.



Stainless steel tray, 1/8" perforations in bottom, solid sides, safety handle hook on both ends for easy removal from the autoclave when hot.

FLASH TRAYS

With lid

OM 81-0340	5" x 7" x 2 1/2"	(127mm x 176mm x 64mm)
OM 81-0345	10" x 6 1/2" x 2 1/2"	(254mm x 165mm x 64mm)
OM 81-0350	10" x 10 1/2" x 3 1/2"	(254mm x 267mm x 89mm)

Without lid

OM 81-0355	5" x 7" x 2 1/2"	(127mm x 176mm x 64mm)
OM 81-0360	10" x 6 1/2" x 2 1/2"	(254mm x 165mm x 64mm)
OM 81-0365	10" x 10 1/2" x 3 1/2"	(254mm x 267mm x 89mm)

Tapered sides and rounded bead design make these basins ideal for storing and pouring.



MIXING/SOLUTION BOWLS

OM PW-12A	2/3 qt.	6 5/8 x 2 1/2	(168mm x 64mm)
OM PW-18A	1 1/4 qt.	8 1/8 x 3	(206mm x 76mm)
OM PW-22A	2 3/8 qt.	9 3/4 x 4	(248mm x 102mm)
OM PW-26A	4 1/2 qt.	11 7/8 x 4 1/2	(302mm x 114mm)
OM PW-30A	6 qt.	12 3/4 x 5 1/4	(324mm x 133mm)
OM PW-32A	7 qt.	13 5/16 x 5 7/16	(338mm x 138mm)
OM PW-40A	12 1/4 qt.	16 1/4 x 6	(413mm x 152mm)



MEDICINE CUP - GRADUATED

OM PW-2 2oz.
2 1/8 x 2 (54mm x 51mm)



IODINE CUP

OM PW-6G 6oz.
3 7/16 x 2 (87mm x 51mm)
OM PW-14G 14oz.
4 3/8 x 2 5/8 (111mm x 67mm)



INSTRUMENT STRINGER OPEN END

OM 83-0010	6" x 2 1/2"	(152mm x 64mm)
OM 83-0015	6" x 3"	(152mm x 76mm)
OM 83-0020	8" x 2 1/2"	(203mm x 64mm)
OM 83-0025	10" x 2 1/2"	(254mm x 64mm)
OM 83-0030	12" x 2 1/2"	(305mm x 64mm)
OM 83-0035	14" x 2 1/2"	(356mm x 64mm)
OM 83-0040	6" x 2 1/2"	(406mm x 64mm)
OM 83-0045	18" x 2 1/2"	(457mm x 64mm)

Note:

- Instrument stringers hold ring handled instruments securely ensuring instruments stay opened during sterilization.
- Locking ball closure keep cross bar in place.
- Stay-closed design prevents accidental opening.
- Expertly hand finished to eliminate any sharp edges.
- Made from German stainless steel.
- To open or close: squeeze side bars together, and then move cross bar.



INSTRUMENT STRINGER CLOSED END

OM 83-0050	4" x 2 1/2"	(102mm x 64mm)
OM 83-0055	6" x 2 1/2"	(152mm x 64mm)
OM 83-0060	8" x 2 1/2"	(203mm x 64mm)
OM 83-0065	10" x 2 1/2"	(254mm x 64mm)
OM 83-0070	12" x 2 1/2"	(305mm x 64mm)
OM 83-0075	14" x 2 1/2"	(356mm x 64mm)
OM 83-0080	16" x 2 1/2"	(406mm x 64mm)
OM 83-0085	18" x 2 1/2"	(508mm x 64mm)



WEINSTEIN STERILIZING RACK

OM 83-0114	10"	(245mm)
OM 83-0116	12"	(305mm)
OM 83-0110	6"	(152mm)
OM 83-0112	8"	(203mm)

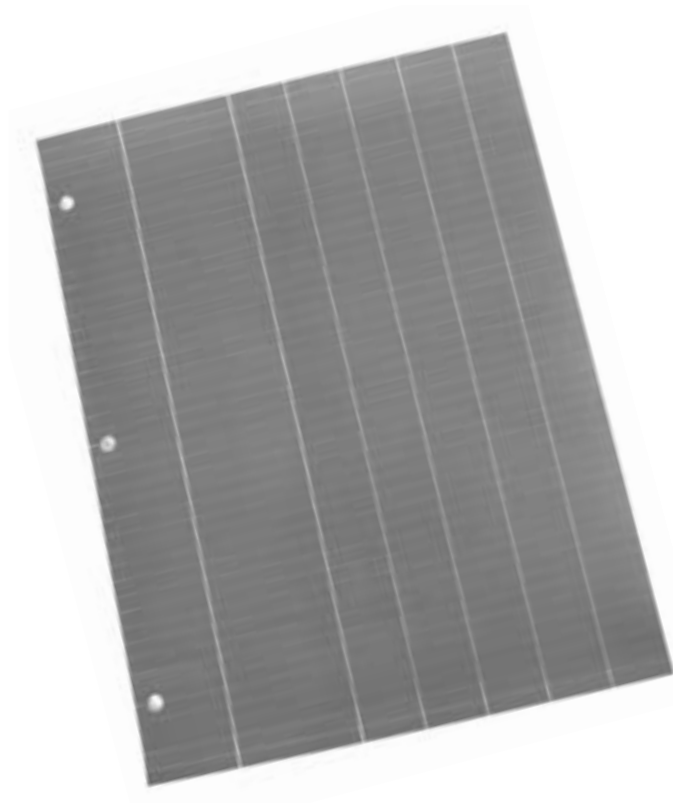

ID SHEET TAPE

Each 8 1/2" x 11" sheet contains 374" (9,500mm) of tape. Last through many autoclaving and gas sterilizing procedures.

Nine colors with white stripes.

OM 81-0100	Dark blue with white stripes
OM 81-0105	Dark green with white stripes
OM 81-0110	Red with white stripes
OM 81-0115	Yellow with white stripes
OM 81-0120	Orange with white stripes
OM 81-0125	Brown with white stripes
OM 81-0130	Lavender with white stripes
OM 81-0135	Light blue with white stripes
OM 81-0140	Pink with white stripes

INSTRUMENT IDENTIFICATION

Autoclavable. Each roll contains 300" (7,620mm) and are 1/4" (6mm) wide. Lasts through many autoclaving and gas sterilizing procedures.



Available in ten colors.

OM 81-0145	White
OM 81-0150	Green
OM 81-0155	Yellow
OM 81-0160	Orange
OM 81-0165	Black
OM 81-0170	Purple
OM 81-0175	Blue
OM 81-0180	Red
OM 81-0185	Brown

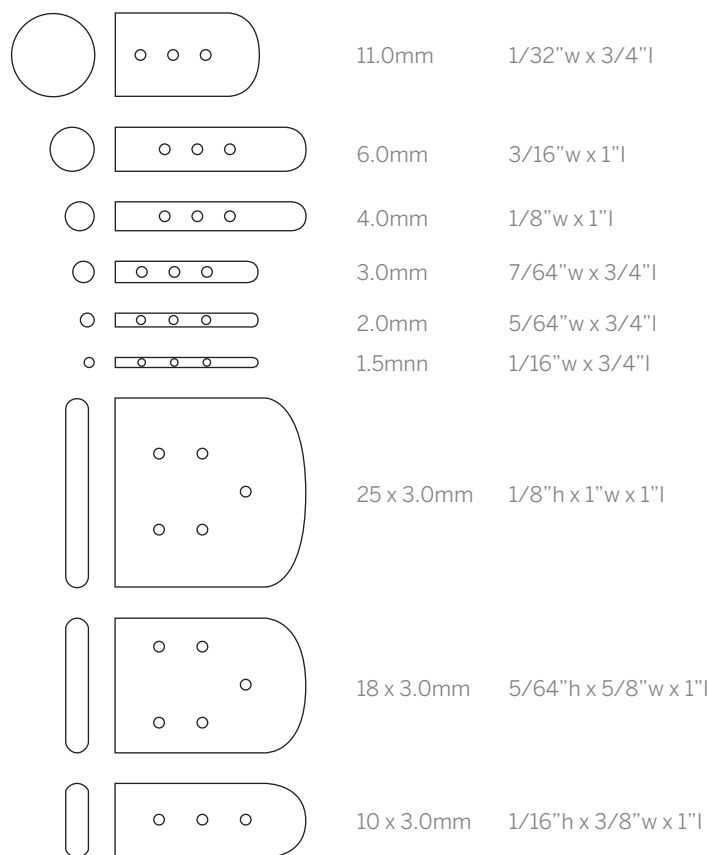

INSTRUMENT PROTECTORS NON-LATEX

Pack of 100

Steam permeable, autoclavable and stretch to fit a wide variety of instrument shapes and sizes.

Vented (shown)

OM 81-0010	11.0mm	1/32" w x 3/4" l	maroon
OM 81-0015	6.0mm	3/16" w x 1" l	yellow
OM 81-0020	4.0mm	1/8" w x 1" l	red
OM 81-0025	3.0mm	7/64" w x 3/4" l	green
OM 81-0030	2.0mm	5/64" w x 3/4" l	blue
OM 81-0035	1.5mm	1/16" w x 3/4" l	white

OM 81-0040	25 x 3.0mm	1/8" h x 1" w x 1" l	black
OM 81-0045	18 x 3.0mm	5/64" h x 5/8" w x 1" l	brown
OM 81-0050	10 x 3.0mm	1/16" h x 3/8" w x 1" l	orange

Non-vented

OM 81-0055	11.0mm	1/32" w x 3/4" l	maroon
OM 81-0060	6.0mm	3/16" w x 1" l	yellow
OM 81-0065	4.0mm	1/8" w x 1" l	red
OM 81-0070	3.0mm	7/64" w x 3/4" l	green
OM 81-0075	2.0mm	5/64" w x 3/4" l	blue
OM 81-0080	1.5mm	1/16" w x 3/4" l	white

OM 81-0085	25 x 3.0mm	1/8" h x 1" w x 1" l	black
OM 81-0090	18 x 3.0mm	5/64" h x 5/8" w x 1" l	brown
OM 81-0095	10 x 3.0mm	1/16" h x 3/8" w x 1" l	orange

Stainless steel fine mesh baskets are used for micro instruments washing, sterilization and storage.

- Top and lid frame wire diameter 3.5mm and 4.0mm (according to the size of the baskets)
- Fine mesh with opening square 1.6mm and wire diameter 0.7mm
- Wire locking clip
- Electrolyte polish

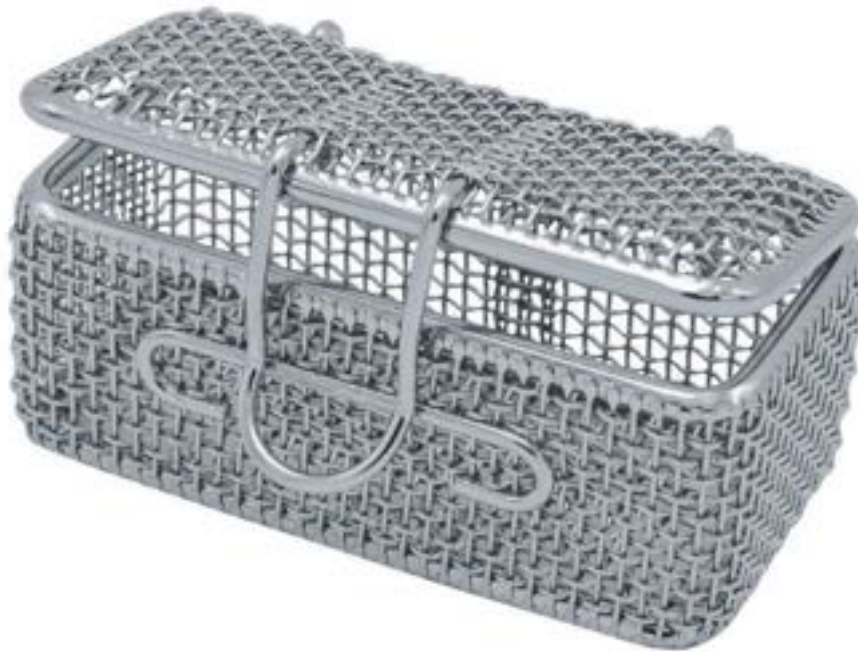

FINE MESH BASKETS

with locking clip

OM 83-0420	80mm x 40mm x 20mm
OM 83-0422	80mm x 40mm x 30mm
OM 83-0423	80mm x 80mm x 34mm
OM 83-0424	80mm x 80mm x 40mm
OM 83-0430	105mm x 70mm x 25mm
OM 83-0432	150mm x 50mm x 35mm
OM 83-0434	190mm x 85mm x 100mm
OM 83-0436	200mm x 100mm x 35mm
OM 83-0440	220mm x 140mm x 50mm
OM 83-0442	235mm x 155mm x 40mm
OM 83-0444	240mm x 90mm x 40mm
OM 83-0445	240mm x 120mm x 35mm
OM 83-0446	275mm x 175mm x 35mm
OM 83-0448	275mm x 200mm x 35mm

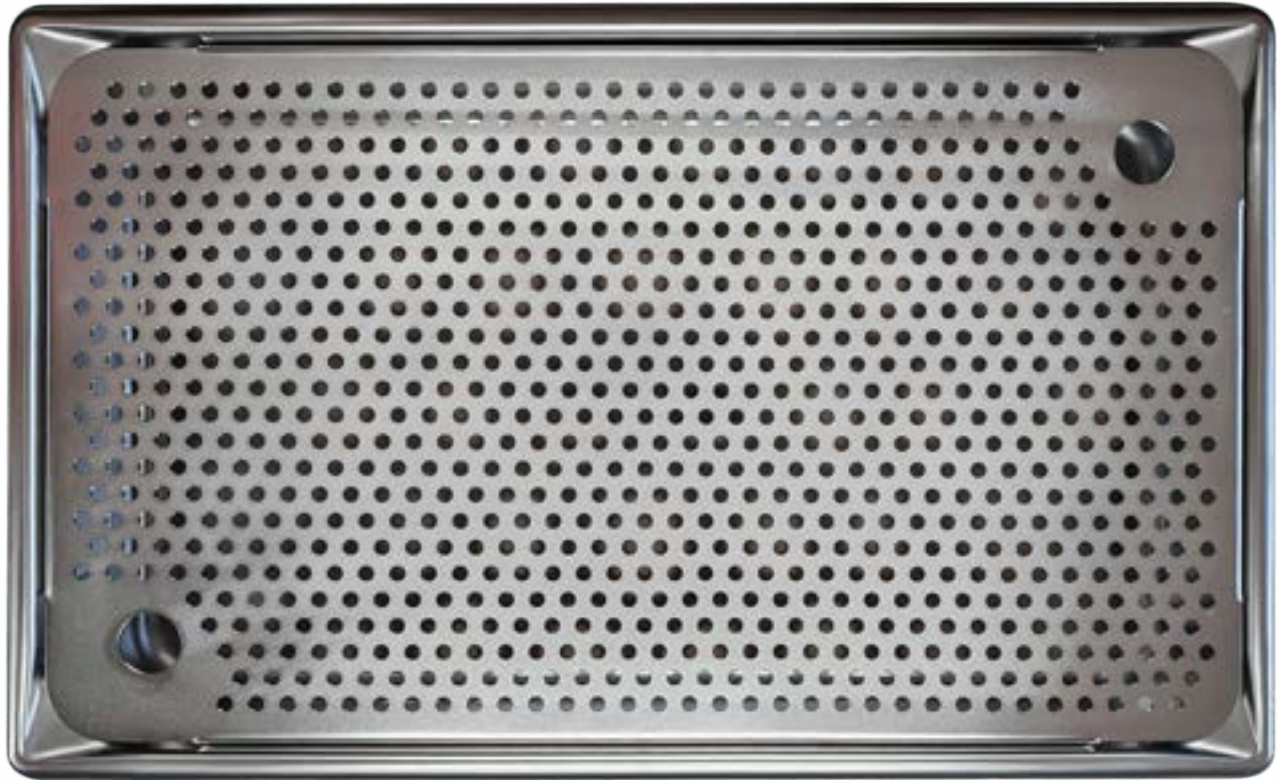

DEBRIDEMENT PAN

With closed-cell screen

OM 2010

21" (533mm) x 13" (330mm) x 3" (76mm)

MISCELLANEOUS INSTRUMENTS



SECTION Z



CONTENTS

Lead Hands	1
Forceps Holders	2
Finger Ring Cutter	2
Pin Wheel	2

Note: Oxidation of lead surfaces is a normal process.



LEAD HAND

OM 49-0092
 9 1/2" (241mm)
 child



LEAD HAND

OM 49-0090
 14" (356mm)
 adult

To prolong the life of lead hands, autoclave temperatures should not exceed 248°F (120°C). Avoid using chemical sterilization as they can cause severe corrosion.

Thinner and more flexible model. Longer fingers wrap on ends eliminating side tabs.



LEAD HAND

OM 49-0093
 9 1/2" (241mm)
 adult
 2mm thick



ORTHOMED FORCEPS HOLDER

OM 39-0672 OM 39-0674 OM 39-0673
6" (152mm) 12" (305mm) 8" (204mm)



BUNT FORCEPS HOLDER

OM 39-0670



FINGER RING CUTTER

OM 29-0430
1/2" (165mm) chrome
with saw blade

Saw blade only.



WARTENBERG NEUROLOGICAL PIN WHEEL

OM 28-0514 7" (178mm)

TRAYS AND RACKS



SECTION AA



To hold instruments for sterilization and storage.

CONTENTS

Hibbs-Brun Rack	1
Lambotte Rack	1
Smith Peterson Rack	1
Brun Rack	2
Hoke Rack	2
Cobb Rack	2
OrthoMed K-Wire and Steinmann Pin Sterilization Cases	3-6



HIBBS-BRUN RACK

OM 98-0180
 12" x 8" x 3" (305mm x 203mm x 76mm)
 Holds twelve 9" (229mm) OrthoMed Brun
 Curettes, Hibbs Chisels, Gouges or Osteotomes



LAMBOTTE RACK

OM 98-0190
 11 1/2" x 8" x 3" (292mm x 203mm x 76mm)
 Holds twelve 9" (229mm) OrthoMed Lambotte
 Osteotomes



SMITH PETERSON RACK

OM 98-0195
 10" x 10" x 1 7/8"
 (254mm x 254mm x 48mm)
 Holds seven 8" (203mm) OrthoMed Smith
 Peterson Osteotomes or Gouges



BRUN RACK

OM 98-0160
9 1/2" x 8" x 3"
(241mm x 203mm x 76mm)
Holds 12 instruments



HOKE RACK

OM 98-0150
8" x 5 1/2" x 1 1/4"
(203mm x 140mm x 32mm)
Holds six instruments



COBB RACK

OM 98-0170
13" x 12" x 1 7/8"
(330mm x 305mm x 48mm)
Holds nine 11" OrthoMed Cobb Currettes,
Elevators, or Gouges

Designed to provide easy access and identification.



The OrthoMed K-Wire and Steinmann Pin Sterilization Case holds popular 4" (102mm), 6" (152mm) and 9" (229mm) K-Wires and 9" (229mm) Steinmann Pins.

Accommodates four each of the following

K-Wire diameters:

- .028" (.7mm)
- .035" (.9mm)
- .045" (1.1mm)
- .062" (1.6mm)

Accommodates two each of the following

Steinmann Pin diameters:

- 5/64" (2.0mm)
- 3/32" (2.4mm)
- 7/64" (2.8mm)
- 1/8" (3.2mm)
- 9/64" (3.5mm)
- 5/32" (4.0mm)
- .177" (4.5mm)

- Removable lid fits under case – taking up less room in the O.R.
- Nylon coated brackets prevent metal-to-metal contact – protecting sharp ends.
- Contents are held in place when closed – preventing shifting.
- Secure locking side brackets help prevent accidental opening.
- Handles at each end for easy transport.
- Anodized aluminum case is lightweight and built to withstand abuse.
- Fully autoclavable to 270°F (132°C).

ORTHOMED K-WIRE AND STEINMANN PIN STERILIZATION CASE

OM 71-0010

11 3/4" x 5 1/4" x 2" (closed)

(298mm x 133mm x 51mm)



Case in closed position.

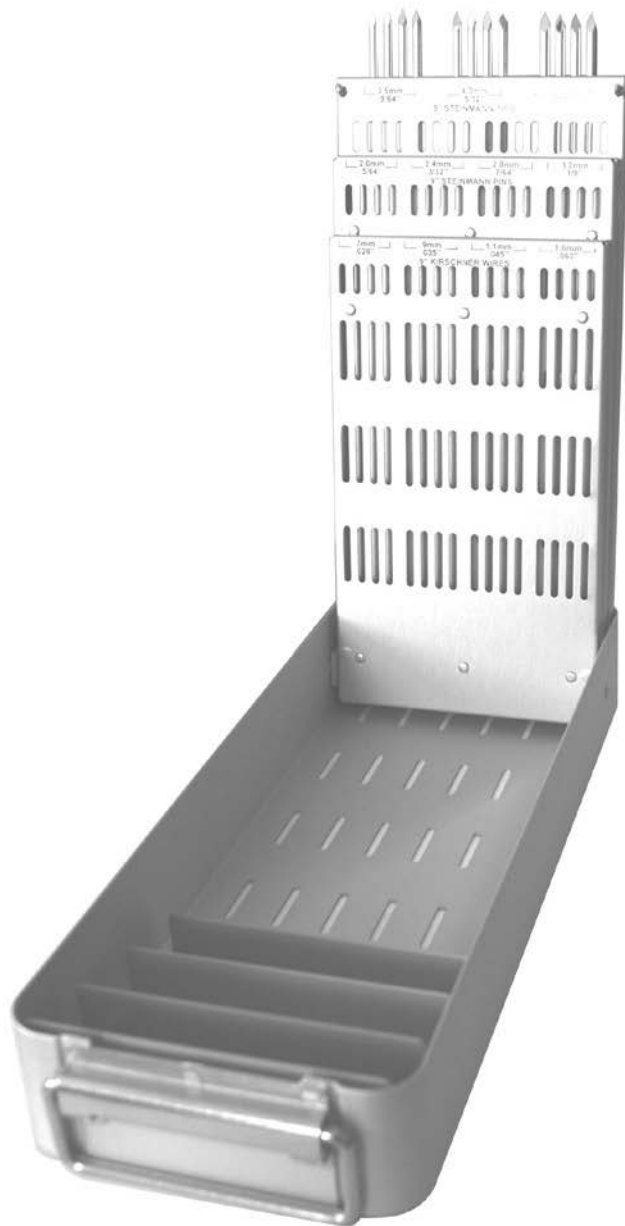

The Orthomed K-Wire and Steinmann Pin Sterilization Case holds popular 9" (229mm) K-Wires and Steinmann Pins.

Accommodates four each of the following K-Wire diameters:

.028" (.7mm)
.035" (.9mm)
.045" (1.1mm)
.062" (1.6mm)

Accommodates four each of the following Steinmann Pin diameters:

5/64" (2.0mm)
3/32" (2.4mm)
7/64" (2.8mm)
1/8" (3.2mm)
9/64" (3.5mm)
5/32" (4.0mm)
.177" (4.5mm)

- Removable lid fits under case – taking up less room in the O.R.
- Nylon coated brackets prevent metal-to-metal contact – protecting sharp ends.
- Contents are held in place when closed – preventing shifting.
- Secure locking side brackets help prevent accidental opening.
- Handles at each end for easy transport.
- Anodized aluminum case is lightweight and built to withstand abuse.
- Fully autoclavable to 270°F (132°C).

ORTHOMED K-WIRE AND STEINMANN PIN STERILIZATION CASE

OM 71-0009

13 5/8" x 5 1/4" x 2 1/4" (closed)

(346mm x 133mm x 57mm)

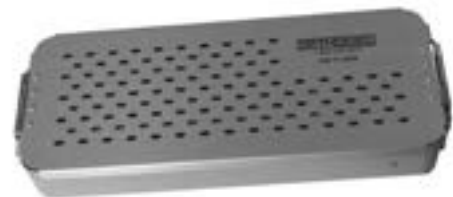

Case in closed position.

The OrthoMed K-Wire sterilization container holds 4" (102mm) or 6" (152mm) K-Wires.

Accommodates six each of the following K-Wire diameters:

- .028" (.7mm)
- .035" (.9mm)
- .045" (1.1mm)
- .054" (1.4mm)
- .062" (1.6mm)

- K-Wire sizes are clearly noted on the inside of case for quick identification and reordering.
- Lid folds back and acts as a support to hold the case in an upright position – taking up less room in the O.R.
- Top of case locks when closed helping to prevent accidental opening.
- Case has a one piece design – eliminates the possibility of losing or switching case parts.
- Anodized aluminum case is lightweight and built to withstand abuse.
- Fully autoclavable to 270°F.



Designed to provide easy access and identification.

Case in open upright position

ORTHOMED K-WIRE STERILIZATION CONTAINER

OM 71-0008

6 1/4" x 4 1/8" x 3/4" (closed)
(158mm x 105mm x 19mm)



Case in closed position.



ORTHOMED K-WIRE AND STEINMANN PIN STERILIZATION CASE

OM 71-0011

13 5/8" x 5 1/4" x 2 1/4" (closed)

(346mm x 133mm x 57mm)

The OrthoMed, Inc. K-Wire and Steinmann Pin Sterilization Case holds popular 9" K-Wires and Steinmann Pins.

Accommodates twelve each of the following K-Wire diameters:

.035" (.9mm)
.045" (1.1mm)
.062" (1.6mm)

Accommodates four each of the following Steinmann Pin diameters:

5/64" (2.0mm)
3/32" (2.4mm)

Accommodates two each of the following Steinmann Pin diameters:

7/64" (2.8mm)
1/8" (3.2mm)
9/64" (3.5mm)
5/32" (4.0mm)

- Removable lid fits under case – taking up less room in the O.R.
- Nylon coated brackets prevent metal-to-metal contact – protecting sharp ends.
- Contents are held in place when closed – preventing shifting.
- Secure locking side brackets help prevent accidental opening.
- Handles at each end for easy transport.
- Anodized aluminum case is lightweight and built to withstand abuse.
- Fully autoclavable to 270°F (132°C).



Case in closed position.

INSTRUMENT SETS



SECTION BB

CONTENTS

Instrument Sets

1-18



MINIMALLY INVASIVE DISCECTOMY SET

OM#	Qty.	Description
OM 55-0510	1	SCOVILLE CURETTE 20" 9x15mm, straight
OM 55-0523	1	BRUN CURETTE 17" 3x6mm, straight
OM 55-0532	1	BRUN CURETTE 17" 2x4mm, 40 degree angle
OM 55-0533	1	BRUN CURETTE 17" 3x6mm, 40 degree angle
OM 55-0543	1	BRUN CURETTE 20" 3x6mm, 40 degree angle
OM 55-0556	1	BRUN CURETTE 20" 6x9mm, 30 degree angle
OM 55-0566	1	CONE RING CURETTE 20" 6mm diameter, 30 degree angle
OM 55-0573	1	CONE RING CURETTE 17" 3mm diameter, 40 degree angle
OM 55-0586	1	EPSTEIN CURETTE 20" 6x9mm, 30 degree reverse angle
OM 55-0593	1	EPSTEIN CURETTE 17" 3x6mm, 40 degree reverse angle
OM 55-0610	1	COBB ELEVATOR 20" 6mm (1/4")
OM 55-0612	1	COBB ELEVATOR 20" 10mm (3/8")
OM 55-0614	1	COBB ELEVATOR 20" 13mm (.490")
OM 55-0620	1	COBB ELEVATOR 17" 6mm (1/4")
OM 55-0630	1	HIBBS GOUGE 18 1/2" 7mm (.28"), straight
OM 55-0640	1	RIB ELEVATOR 17" 9mm radius tip, 45 degree angle
OM 55-0642	1	HIBBS OSTEOTOME 18 1/2" 10mm (3/8") straight
OM 55-0644	1	RIB ELEVATOR 17" 9mm radius tip, 90 degree angle
OM 55-0654	1	PENFIELD ELEVATOR 15" 4mm (.16")
OM 55-0662	1	NERVE PROBE 15" with ball tip, 45 degree angle
OM 55-0664	1	NERVE PROBE 15" with ball tip, 90 degree angle
OM 55-0676	1	BONE TAMP 17" 3/8" diameter
OM 55-0762	1	FERRIS-SMITH RONGEUR 20" 2.5x10mm bite, straight
OM 55-0763	1	FERRIS-SMITH RONGEUR 20" 4x10mm bite, straight
OM 55-0767	1	FERRIS-SMITH RONGEUR 20" 4x10mm bite, angle up
OM 55-0777	1	FERRIS-SMITH RONGEUR 20" 8x12mm bite, straight, serrated
OM 55-0782	1	KERRISON PUNCH 20" 4mm bite, 90 degree down
OM 55-0788	1	KERRISON PUNCH 20" 2.5mm bite, 40 degree forward
OM 55-0790	1	KERRISON PUNCH 20" 4mm bite, 40 degree forward

LAMINECTOMY SET

OM#	Qty.	Description
OM 29-0059	2	SCALPEL HANDLE #3
OM 29-0060	1	SCALPEL HANDLE #4
OM 29-0061	1	SCALPEL HANDLE #3L
OM 29-0062	1	SCALPEL HANDLE #7
OM 35-0298	1	SUPER-CUT MAYO SCISSORS 6 3/4" Curved
OM 35-0382	1	SUPER-CUT METZENBAUM SCISSORS 6" Curved
OM 35-0394	1	SUPER-CUT METZENBAUM SCISSORS 7" Curved
OM 36-0178	4	CRILE FORCEPS 5 1/2" Curved
OM 36-0318	2	ROCH PEAN FORCEPS 6 1/4" Curved
OM 36-0436	2	ROCH-OCHSNER FORCEPS 8" Straight
OM 36-0744	2	ADSON HEMOSTATIC FORCEPS 7 1/4" Straight
OM 36-0746	2	ADSON HEMOSTATIC FORCEPS 7 1/4" Curved
OM 37-0462	4	BACKHAUS TOWEL FORCEPS 5 1/4"
OM 37-0468	6	LORNA (EDNA) TOWEL FORCEPS 5 1/4"
OM 38-0100	1	DRESSING FORCEPS 10"
OM 38-0184	2	CUSHING BAYONET DRESSING FORCEPS 7 1/4" Serrated
OM 38-0186	2	CUSHING BAYONET TISSUE FORCEPS 7 1/4" 1 x 2 Teeth
OM 38-0272	2	TISSUE FORCEPS 5 1/2" 1 x 2 Teeth
OM 39-0050	2	ADSON FORCEPS 6" 1 x 2 Teeth 1.2mm
OM 39-0692	1	RULER 6" INCH AND MM GRADUATED, Flexible
OM 41-0302	2	MAYO HEGAR NEEDLEHOLDER 6" Serrated, Carbide
OM 41-0314	2	MAYO HEGAR NEEDLEHOLDER 8" Serrated, Carbide
OM 42-0152	2	SAROT NEEDLEHOLDER 7 1/2" Carbide
OM 42-0863	1	FRAZIER SUCTION TUBES 4 1/2" Angled, 7 French
OM 42-0864	1	FRAZIER SUCTION TUBES 4 1/2" Angled, 9 French
OM 42-0866	1	FRAZIER SUCTION TUBES 4 1/2" Angled, 11 French
OM 42-0876	1	FRAZIER SUCTION TUBES 7 1/2" Angled, 11 French
OM 43-0112	2	ALLIS TISSUE FORCEPS 6" 4 x 5 teeth
OM 46-0667	1	ORTHOPEDIC MALLET 10 1/2", 31b./21b.
OM 46-0899	1	BONE TAMP 6", 10mm Diameter, Cross-serrated
OM 48-0217	2	INGE RETRACTOR 6 1/2"
OM 49-0170	2	DEBAKEY ATRAUMA TISSUE FORCEPS 8", 1.5mm
OM 51-0059	2	HIBBS RETRACTOR 9 1/2", 50mm
OM 51-0200	2	RICHARDSON RETRACTOR 9 1/2", 3/4" x 1"
OM 51-0204	2	RICHARDSON RETRACTOR 9 1/2", 1 1/2" x 1 1/2"
OM 51-0372	2	U.S. ARMY RETRACTOR 8 1/2"
OM 51-0530	1	LOVE RETRACTOR 8 1/2" Straight blade
OM 51-0532	1	LOVE RETRACTOR 8 1/2" 45° Angled blade
OM 51-0534	1	LOVE RETRACTOR 8 1/2" 90° Angled blade
OM 52-0266	2	VOLKMAN RETRACTOR 8 1/2", 6 Sharp prongs
OM 52-0444	2	ADSON RETRACTOR 7 1/2", Angled 4 x 4 Sharp prongs
OM 52-0458	1	TAYLOR SPINAL RETRACTOR 7 1/4", 1 1/4" x 3"
OM 52-0460	1	TAYLOR SPINAL RETRACTOR 8", 1 1/4" x 4"
OM 52-0484	2	BECKMAN-ADSON RETRACTOR 12 1/4", 1" x 1" Blunt
OM 52-0498	2	WEITLANER RETRACTOR 5 1/2" Sharp
OM 52-0502	2	WEITLANER RETRACTOR 6 1/2" Sharp
OM 52-0532	2	BECKMAN-WEITLANER RETRACTOR 6 1/2", 3 x 4 Sharp prongs
OM 53-0160	1	STRABISMUS SCISSORS 4" Straight
OM 53-0164	1	STRABISMUS SCISSORS 4" Curved
OM 55-0300	1	WOODSON ELEVATOR and SPATULA 10"
OM 55-0302	1	WOODSON DURAL SEPARATOR and PACKER 7"
OM 55-0440	1	MARKHAM-MEYERDING HEMILAMINECTOMY RETRACTOR 7" Left
OM 55-0441	1	MARKHAM-MEYERDING HEMILAMINECTOMY RETRACTOR 7" Right
OM 57-0614	2	FREER ELEVATOR 7 1/2"
OM 57-0615	2	KLEINERT-KUTZ ELEVATOR/DISSECTOR 7 3/4"
OM 57-0624	1	PENFIELD ELEVATOR 7" Style 1
OM 57-0626	1	PENFIELD ELEVATOR 7 3/4" Style 2
OM 57-0628	1	PENFIELD ELEVATOR 7 3/4" Style 3
OM 57-0630	1	PENFIELD ELEVATOR 8" Style 4



NAIL SET

All the instruments you need - at your fingertips

Each Nail Set contains:

OM#	Qty.	Description
OM 29-0058	1	SCALPEL HANDLE #3
OM 33-0324	1	OPERATING SCISSORS 5 1/2" straight bl/bl
OM 36-0156	2	MOSQUITO FORCEPS 5" straight
OM 36-0158	2	MOSQUITO FORCEPS 5" curved
OM 36-0166	1	KELLY FORCEPS 5 1/2" straight
OM 39-0092	1	ADSON BROWN FORCEPS 4 3/4" 9 x 9
OM 41-0170	1	CRILE-WOOD NEEDLE HOLDER 6" serrated
OM 57-0614	1	FREER PERIOSTEAL ELEVATOR 7 1/2"
OM 69-0294	1	TISSUE NIPPER 5" medium
OM 69-0326	1	NAIL SPLITTER FORCEPS 5" medium jaw
OM 69-0344	1	NAIL SPLITTER FORCEPS 6" heavy, fine point
OM 69-0448	1	NAIL SPLITTER FORCEPS 4 1/2" thin jaw
OM 69-0457	1	CURETTE #4,5" 4mm McGlamry Bullneck
OM 69-0484	1	CURETTE #2,5" 2.5mm with hole
OM 69-0538	1	NAIL RASP 6 3/4" angled double end
OM 69-0579	1	LOCKE ELEVATOR 5" narrow, McGlamry Bullneck
OM 69-0590	1	LOCKE ELEVATOR 5" wide, McGlamry Bullneck (Sorry, no substitutions)

Sterilizing and Storage Containers (optional)

OM 46-0544	1	STERILIZING CONTAINER 9" x 5" x 2" small
OM 46-0545	1	STERILIZING CONTAINER 11" x 9" x 2" large

(Instruments will fit into either container. Before ordering, please check size of your autoclave chamber.)

OM 69-0900	1	P.I. NAIL PACK (Instruments only)
OM 69-0901	1	P.I. NAIL PACK AND SMALL CONTAINER
OM 69-0902	1	P.I. NAIL PACK AND LARGE CONTAINER

Instrument Management Made Easy

If you've ever reached for a specific instrument while performing a procedure, only to find it missing from your tray, you know why we created the Nail Set. It includes every instrument you need for nail procedures.

Designed For Flexible Use

The Nail Set was developed, tested, and approved by The Podiatry Institute®. The idea was to make it very flexible, for many different potential nail and digit related conditions. With the addition of another instrument or two, it also works well for arthroplasties, the removal of small extoses, or as a laceration tray.

Efficient and Portable

The optional sterilization/storage container, available in two sizes, allows you to sterilize and store the whole set together. By always sterilizing the complete set, you avoid cross contamination between the used and unused instruments. The removable lid can also be used as a tray.

For Office or Hospital Use

If you need to update a worn or incomplete instrument set, are planning to equip new offices, or are simply tired of finding needed instruments missing from the tray laid out for you, the Nail Set is the perfect solution. Identify your instrument sets with custom engraved, personalized aluminum tags on the container.

INTERNAL FIXATION SET

SMALL FRAGMENT SCREW FIXATION SET

OM 48-0410

includes one each of the following items:

OM#	Qty.	Description
OM 47-0137	1	BONE REDUCTION FORCEPS, POINTED 5 1/4" (133mm)
OM 47-0880	1	SHARP HOOK 6" (152mm)
OM 47-0128	1	BONE REDUCTION FORCEPS 6" (152mm) curved jaw
OM 48-0054	1	DRILL BIT 2.0mm, 4" (102mm)
OM 48-0057	1	DRILL BIT 2.5mm, 4 1/2" (114mm)
OM 48-0058	1	DRILL BIT 2.7mm, 4" (102mm)
OM 48-0063	1	DRILL BIT 3.5mm, 4 1/2" (114mm)
OM 47-0922	1	COUNTERSINK SMALL 2.0mm, 2 3/4" (70mm)
OM 48-0110	1	TAP 2.7mm, 4" (102mm)
OM 48-0112	1	TAP 3.5mm, 5" (127mm) fine thread
OM 48-0114	1	TAP 3.5mm, 4 1/2" (114mm) 1.75mm thread
OM 47-0904	1	QUICK COUPLING HANDLE 4 1/2" (114mm) small
OM 47-0970	1	DRILL GUIDE for 2.0mm drill, 4 1/4" (108mm)
OM 47-0972	1	TAP SLEEVE 2.5mm drill & 3.5mm screw, 5" (127mm)
OM 47-0974	1	INSERT DRILL SLEEVE 3.5/2.7mm, 1 1/2" (38mm)
OM 47-0953	1	SCREWDRIVER BIT 2.5mm, 4" (102mm)
OM 47-0955	1	SLEEVE FOR SCREWDRIVER OM 47-0953, 2" (51 mm)
OM 47-0936	1	DEPTH GAUGE small 6 1/4" (159mm)
OM 48-0412	2	INSTRUMENTTRAYS (with covers) Tray 1: size 9" x 5" x 1 1/4" (229mm x 127mm x 33mm) Tray 2: size 9" x 5" x 1 1/2" (229mm x 127mm x 38mm)

BASIC SCREW SET

OM 73-0001

Two trays with cover

Accommodates 6 each of 1.5mm through 4.0mm screws as long as they are made according to ISO standards (not included with trays).

Includes OM 41-0930 Screw Holding Forceps.

Tray 1: size 9" x 5" x 1 1/2" (229mm x 127mm x 38mm)

Tray 2: size 9" x 5" x 2 1/2" (229mm x 127mm x 64mm)

Combined size of all 4 trays: 9" x 5" x 7" (229mm x 127mm x 178mm)

MINI FIXATION SET

OM 48-0414

For 1.5mm and 2.0mm screws

OM#	Qty.	Description
OM 48-0051	1	DRILL BIT 1.1mm, 2 1/2" (64mm)
OM 48-0052	1	DRILL BIT 1.5mm, 3 1/2" (89mm)
OM 48-0054	1	DRILL BIT 2.0mm, 4 1/2" (114mm)
OM 47-0920	1	MINI COUNTERSINK 1.1 mm, 2 1/4" (57mm)
OM 48-0106	1	TAP 1.5mm, 2" (51mm)
OM 48-0108	1	TAP 2.0mm, 2 1/4" (57mm)
OM 47-0902	1	MINI QUICK COUPLING HANDLE, 4 1/4" (114mm)
OM 47-0968	1	MINI DRILL SLEEVE for 1.1 & 1.5mm drill bits
OM 47-0950	1	SCREWDRIVER BIT 1.5mm, 2 1/4" (57mm)
OM 47-0934	1	MINI DEPTH GAUGE, 4 1/4" (114mm)

| **Note:** To house the OrthoMed Mini Fixation Set, we recommend Container OM 46-0544 and Silicone Mat OM 98-0125.

To order screws and plates please refer to
Section T.

INSTRUMENTS FOR MINI FRAGMENT FIXATION

1.5mm, 2mm and 2.7mm screws

OM#	Qty.	Description
OM 45-0208	1	SCREWHOLDING FORCEPS 3 1/2"
OM 46-0206	1	PERIOSTEAL ELEVATOR, 3mm Width
OM 46-0623	1	WIRE CUTTER 7" ANGLED MAX CAP 1.6mm
OM 46-0830	1	MINI HOHMANN RETRACTOR 6 1/2" 6mm
OM 46-0832	1	MINI HOHMANN RETRACTOR 6 1/2" 8mm
OM 47-0119	1	STAGBEEETLE FORCEPS 120mm
OM 47-0133	1	BONE REDUCTION FORCEPS WITH POINTS, 5" Narrow
OM 47-0135	1	BONE REDUCTION FORCEPS WITH POINTS, 5 1/2" Broad
OM 47-0880	1	SHARP HOOK 6" (152mm)
OM 47-0902	1	HANDLE FOR MINI QC INSTRUMENTS 4 1/4"
OM 47-0904	1	QUICK COUPLING HANDLE 4 1/2"
OM 47-0915	1	BENDING IRON FOR 5 1/2" 2.7mm + 3.5mm
OM 47-0916	1	BENDING IRON FOR SMALL PLATES 5 1/2" (140mm)
OM 47-0917	1	PLATE BENDING IRON 4 3/4" 1.8mm
OM 47-0920	1	COUNTERSINK MINI 1.1mm
OM 47-0922	1	COUNTERSINK SMALL 2.0mm 7cm
OM 47-0931	2	BENDING PLIERS FOR 1.5mm and 2.0mm Plates
OM 47-0932	1	PLATE CUTTING FORCEPS
OM 47-0934	1	MINI DEPTH GAUGE 30mm
OM 47-0936	1	SCREW DEPTH GAUGE 50mm
OM 47-0950B	1	MINI HEX SCREWDRIVER BIT
OM 47-0953	1	SCREWDRIVER BIT 2.5mm; 10cm QC
OM 47-0955	1	SLEEVE FOR SCREWDRIVER 47-0952 & 47-0953
OM 47-0959	1	SLEEVE ONLY FOR MINI HEX and CRUCIFORM DRIVER SHAFTS
OM 47-0966	1	2.0MM/1.5MM DOUBLE DRILL SLEEVE
OM 47-0968	1	MINI DRILL SLEEVE 4 1/4"
OM 48-0002	1	2.0MM/2.7MM DOUBLE DRILL SLEEVE
OM 48-0051	2	DRILL BIT QC 1.1 mm, 60/35mm
OM 48-0052	2	DRILL BIT QC 1.5mm, 85/60mm
OM 48-0054	2	DRILL BIT QC 2.0mm, 100/75mm
OM 48-0058	2	DRILL BIT QC 2.7mm, 100/75mm
OM 48-0106	2	TAP 1.5mm, 2"
OM 48-0108	2	TAP 2.0mm, 2 1/4"
OM 48-0110	2	TAP 2.7mm, 10cm QC
OM 48-0242	1	NEEDLE NOSE PLIERS 5 1/2" Delicate with groove
OM 48-0368	1	SCREWDRIVER 2.5mm Hex with notch

Optional

OM 45-0004	1	MINI CRUCIFORM SCREWDRIVER BIT QC
OM 46-0212	1	PERIOSTEAL ELEVATOR 7 1/4" 6mm Curved
OM 46-0827	1	HOHMANN RETRACTOR 6" 15mm Broad tip
OM 47-0137	1	BONE REDUCTION FORCEPS POINTED 5 1/4"
OM 47-0138	1	PLATE HOLDING FORCEPS 5 1/2"
OM 47-0139	1	BONE COMPRESSION FORCEPS 5"
OM 48-0370	1	GRATLOCH™ K-WIRE BENDER 7 1/2"

To order screws and plates please refer to Section T.

SMALL FRAGMENT SET

INSTRUMENTS FOR SMALL FRAGMENT FIXATION

3.5mm and 4.0mm screws

OM#	Qty.	Description
OM 45-0002	1	ADAPTOR (POWER) for QC Instruments
OM 45-0126	1	BENDING TEMPLATE 5 HOLE 3.5mm
OM 45-0127	1	BENDING TEMPLATE 7 HOLE 3.5mm
OM 45-0128	1	BENDING TEMPLATE 9 HOLE 3.5mm
OM 45-0210	1	SCREWHOLDING FORCEPS 3 1/2"
OM 46-0212	1	PERIOSTEAL ELEVATOR 7 1/4" Straight 6mm round curved
OM 46-0827	2	HOHMANN RETRACTOR 6" 15mm broad tip
OM 46-0832	2	MINI HOHMANN RETRACTOR 6 1/2" 8mm
OM 47-0092	1	VERBRUGGE FORCEPS, SELF-CENTERING 7 1/2" (191 mm)
OM 47-0128	1	BONE REDUCTION FORCEPS 6" small curved
OM 47-0133	1	BONE REDUCTION FORCEPS WITH POINTS 5" Narrow
OM 47-0135	1	BONE REDUCTION FORCEPS WITH POINTS 5 1/2" Broad
OM 47-0880	1	SHARP HOOK 6"(152mm)
OM 47-0915	1	PLATE BENDING IRON 5 1/2" 2.7mm & 3.5mm
OM 47-0916	1	BENDING IRON FOR SMALL PLATES 5 1/2" (140mm)
OM 47-0919	2	BENDING IRON FOR 3.5mm & 4.5m Recon plates
OM 47-0922	1	COUNTERSINK SMALL 2.0mm 7cm
OM 47-0936	1	SCREW DEPTH GAUGE 50mm
OM 47-0947	1	BENDING TEMPLATE 22 HOLE for 3.5mm Recon plates
OM 47-0960	1	T-HANDLE QUICK COUPLING
OM 47-0970	1	DRILL GUIDE for 2mm Drill DE; 10.5mm
OM 47-0972	1	TAP SLEEVE 2.5mm Drill & 3.5mm Screw
OM 47-0974	1	INSERT DRILL SLEEVE 3.5/2.7mm Screw
OM 47-0978	1	DRILL GUIDE NEUTRAL & LOAD 2.5/3.5mm
OM 48-0004	1	3.5MM UNIVERSAL DRILL GUIDE
OM 48-0057	2	DRILL BILL QC 2.5mm, 110/85mm Gold
OM 48-0063	2	DRILL BIT QC 3.5mm, 110/85mm
OM 48-0112	2	TAP 3.5mm; 12cm QC, Fine thread gold
OM 48-0114	2	TAP 3.5mm; 11cm QC, 1.75mm Pitch
OM 48-0242	1	NEEDLE NOSE PLIERS 5 1/2" Delicate with groove
OM 48-0348	1	SCREWDRIVER SHAFT QC 2.5mm Hex with notch
OM 48-0365	1	SLEEVE ONLY FOR OM 48-0348/48-0364/48-0368
OM 48-0368	1	SCREWDRIVER 2.5mm Hex with notch
OM 48-0372	1	WIRE AND PIN BENDER 6" 3.2mm (1/8")

Optional

OM 45-0129	1	BENDING TEMPLATE 12 Hole 3.5mm
OM 46-0624	1	WIRE CUTTER
OM 46-0632	1	PIN CUTTER 10" Small
OM 46-0830	1	MINI HOHMANN RETRACTOR 6 1/2" 6mm
OM 47-0090	1	VERBRUGGE FORCEPS SELF CENTERING 6" (152mm)
OM 47-0137	1	BONE REDUCTION FORCEPS POINTED 5 1/4" (133mm)
OM 47-0904	1	QUICK COUPLING HANDLE 4 1/2" (114mm)
OM 47-0925	1	BENDING PLIERS FOR SMALL PLATES
OM 47-0953	1	SCREWDRIVER BIT 2.5mm; 10cm QC
OM 47-0955	1	SLEEVE FOR SCREWDRIVER 47-0952 & 47-0953
OM 48-0370	1	GRATLOCH™ K-WIRE BENDER 7 1/2" (191mm)



MINI BONE WIRE SET

OM 48-0400

This set is ideal for offices and surgi-centers. The compact sterilization case will fit all sizes of autoclaves.

Each Nail Set contains:

OM#	Qty.	Description
Instruments		
OM 46-0544	1	STERILIZING CONTAINER 9" x 5" x 2"
OM 46-0651	1	DIAMOND PIN CUTTER 6 1/4" (159mm)
OM 48-0245	1	NEEDLE NOSE PLIERS 5 1/2" (140mm)
OM 48-0370	1	GRATLOCH™ WIRE BENDER 7 1/2" (191 mm)
OM 69-0846	1	WIRE TWISTER AND TIGHTENER 6 1/4" (159mm)

K-Wire one package (6 wires) of each

OM 71-0100	1	DOUBLE TROCAR 4" .028" (0.7mm) diameter
OM 71-0101	1	DOUBLE TROCAR 4" .035" (0.9mm) diameter
OM 71-0102	1	DOUBLE TROCAR 4" .045" (1.1 mm) diameter
OM 71-0103	1	DOUBLE TROCAR 4" .062" (1.6mm) diameter

Cerclage Wire 10 meters in length

OM 72-0104	1	0.4mm diameter
OM 72-0106	1	0.6mm diameter
OM 72-0108	1	0.8mm diameter

Optional

OM 46-0540	1	VICKERS EASIDRIVER™
OM 46-0542	1	VICKERS K-WIRE DISPENSER™

SMALL BONE WIRE SET



SMALL BONE WIRE SET

OM 48-0402

This set is useful for foot, ankle and hand surgery, and all other small bone work

Each set contains:

OM#	Qty.	Description
Instruments		
OM 46-0547	1	STERILIZING CASE 20"x 8" x 2"
OM 46-0542	1	VICKERS K-WIRE DISPENSER™ 4" (102mm)
OM 46-0622	1	DELICATE WIRE CUTTER 4 3/4" (121mm)
OM 46-0651	1	DIAMOND PIN CUTTER 6 1/4" (159mm)
OM 48-0245	2	NEEDLE NOSE PLIERS 5 1/2" (140mm)
OM 48-0320	2	WIRE TWISTING FORCEPS 6" (152mm)
OM 48-0370	1	GRATLOCH™ WIRE BENDER 7 1/2" (191mm)
OM 48-0386	1	WIRE PASSER (CANNULATED) 7" (178mm)
OM 48-0602	1	LOCKING PLIERS 8" (203mm)
OM 48-0604	1	PARALLEL PLIERS 7" (178mm)
OM 69-0846	1	WIRE TWISTER AND TIGHTENER 6 1/4" (159mm)

K-Wire one package (6 wires) of each

OM 71-0100	1	DOUBLE TROCAR 4" .028" (0.7mm) diameter
OM 71-0101	1	DOUBLE TROCAR 4" .035" (0.9mm) diameter
OM 71-0102	1	DOUBLE TROCAR 4" .045" (1.1 mm) diameter
OM 71-0103	1	DOUBLE TROCAR 4" .062" (1.6mm) diameter
OM 71-0021	1	DOUBLE TROCAR 6" .028" (0.7mm) diameter
OM 71-0022	1	DOUBLE TROCAR 6" .035" (0.9mm) diameter
OM 71-0023	1	DOUBLE TROCAR 6" .045" (1.1mm) diameter
OM 71-0025	1	DOUBLE TROCAR 6" .062" (1.6mm) diameter

Cerclage Wire 10 meters in length

OM 72-0110	1	1.0mm diameter
OM 72-0112	1	1.2mm diameter

Optional

OM 46-0540	VICKERS EASIDRIVER™	
OM 71-0001, 71-0002, 71-0003, 71-0004, 71-0006 K-WIRE DISPENSERS		



LARGE BONE WIRE SET

OM 48-0404

This set is contains the following.

OM#	Qty.	Description	
Instruments			
OM 46-0547	1	STERILIZING CASE 19" x 7 3/4" x 2"	
OM 46-0574	2	DOUBLE ACTION EXTRACTING PLIERS	
OM 46-0619	1	LOUTE WIRE TIGHTENER 8 1/2" (216mm)	
OM 46-0624	1	DOUBLE ACTION WIRE CUTTER 8 1/2" (216mm)	
OM 46-0651	1	DIAMOND PIN CUTTER 6 1/4" (159mm)	
OM 48-0245	1	NEEDLE NOSE PLIERS 5 1/2" (140mm)	
OM 69-0846	1	WIRE TWISTER AND TIGHTENER 6 1/4" (159mm)	
OM 48-0370	1	GRATLOCH™ WIRE BENDER 7 1/2" (191 mm)	
OM 48-0386	1	WIRE PASSER (CANNULATED) 7" (178mm)	
OM 48-0388	1	WIRE PASSER (CANNULATED) 9 1/2" (241mm)	
OM 48-0602	1	LOCKING PLIERS 8" (203mm)	
OM 48-0604	1	PARALLEL PLIERS 7" (178mm)	
OM 48-0324	4	WIRE TWISTING FORCEPS 7 1/4" (184mm)	
K-Wire one package (6 wires) of each			DISPENSER one each
OM 71-0111	1	DOUBLE TROCAR 9" .035" (0.9mm) diameter	OM 71-0012
OM 71-0112	1	DOUBLE TROCAR 9" .045" (1.1mm) diameter	OM 71-0013
OM 71-0114	1	DOUBLE TROCAR 9" .054" (1.4mm) diameter	OM 71-0014
OM 71-0113	1	DOUBLE TROCAR 9" .062" (1.6mm) diameter	OM 71-0016
Steinmann Pins one package (6 wires) of each			DISPENSER one each
OM 71-0450	1	DOUBLE TROCAR 9" 5/64" (2.0mm) diameter	OM 71-0017
OM 71-0453	1	DOUBLE TROCAR 9" 3/32" (2.4mm) diameter	OM 71-0019
Cerclage Wire 10 meters in length			
OM 72-0112	1	1.2mm diameter	
OM 72-0115	1	1.5mm diameter	
Optional			
OM 46-0540		VICKERS EASIDRIVER™	

Note: For ordering larger Steinmann Pins and the corresponding cutters, please refer to the appropriate sections elsewhere in the catalog.

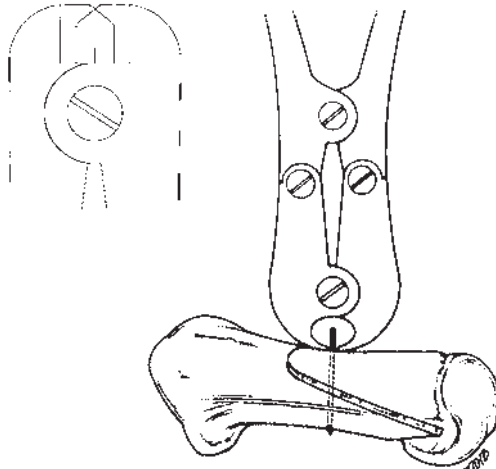

Drawing shows the P.I. Wire Cutter cutting flush to the bone. It is both front and side cutting.

OM 46-0631
7" (178mm) front and side cutting
with carbide inserts
cuts up to .062" (1.6mm)

FLUSH WIRE CUTTER

Our Flush Cutter cuts K-Wire flush to the bone like no other wire cutter. Double action for ease, comfort and power with tungsten carbide jaws for long life and sharpness.

Note:

To achieve the best results when cutting wire, follow these simple steps.

- Choose the appropriate cutter for the wire diameter you want to cut.
- Cut wire in the middle of the jaw not on the edge or in the corner.
- Make a first cut leaving a piece about 1/4" long. Now you can position the cutter for its second and flattest cut.
- When cutting, do not twist and turn the cutter. Just press the handles together.

When removing K-Wire, use the P.I. Plug Cutter to extract a tiny cylinder of bone around the tip of the wire.

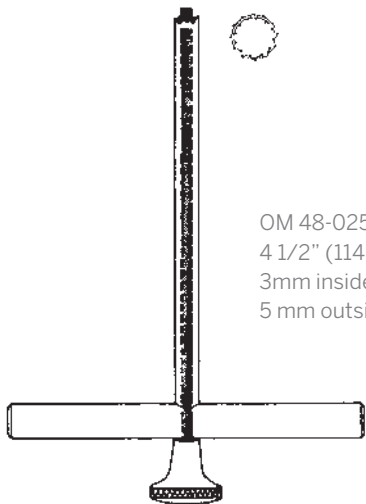

OM 48-0252
4 1/2" (114mm) with obturator
3mm inside diameter
5 mm outside diameter

PLUG CUTTER

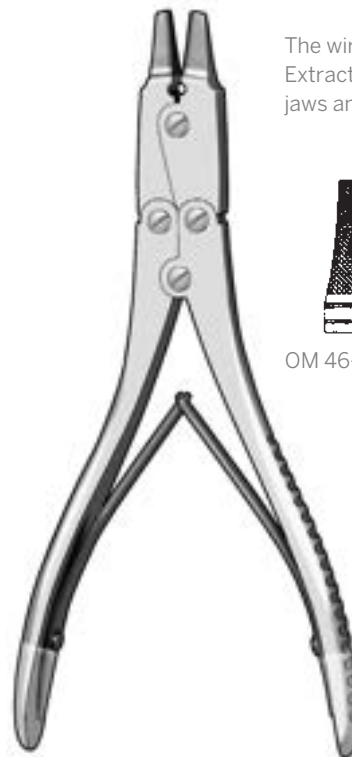

The wire can then be easily grasped with our Extraction Pliers. Long lasting tungsten carbide jaws and double action for grasping

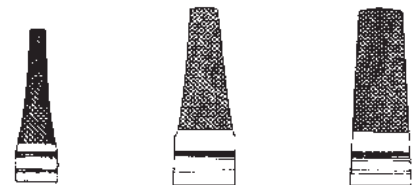

OM 46-0572 OM 46-0573 OM 46-0574

OM 46-0572
7" (178mm) 2mm jaw
carbide

OM 46-0573
7" (178mm) 4mm jaw
carbide

OM 46-0574
7" (178mm) 6mm jaw
carbide

DOUBLE ACTION WIRE EXTRACTION PLIERS



MICRO SURGERY SET (MAJOR SET)

OM 69-0915

Complete set includes one each of the following:

- OM 44-0012 MICRO TYING FORCEPS 4 3/8" (111mm) 0.3mm tip
- OM 44-0032 BARRAQUER NEEDLE HOLDER 5" (127mm) curved, with lock
- OM 44-0018 MICRO SCISSORS 5" (127mm) straight, long blade, round handle
- OM 53-0380 GRAEFE IRIS FORCEPS 4" (162mm) straight 1x2 teeth
- OM 44-0028 MICRO CLAMP APPLICATOR 5 1/2" (140mm)
- OM 44-0030 APPROXIMATION CLAMP without suture holding frame
- OM 44-0022 MICRO SCISSORS (REILL) 5 1/2" (140mm) curved, serrated
- OM 44-0014 PLATFORM TYING FORCEPS 5 1/2" (140mm) 0.7mm tip
- OM 44-0024 HEPP-SCHEIDEL DISSECTING SCISSORS 5 1/2" (140mm) curved
- OM 44-0031 CLAMP BOX for micro clamps OM 44-0030
- OM 98-0135 STERILIZATION AND INSTRUMENT CASE for eight piece micro set
- OM 98-0136 INSTRUMENT RACK for eight piece micro set

MICRO SURGERY SET (MINI SET)

OM 69-0917

Complete set includes one each of the following:

- OM 44-0014 PLATFORM TYING FORCEPS 5 1/2" (140mm) 0.7mm tip
- OM 44-0032 BARRAQUER NEEDLE HOLDER 5" (127mm) curved with lock
- OM 44-0020 MICRO SCISSORS 5" (127mm) curved, long blade, round handle
- OM 98-0137 STERILIZATION AND INSTRUMENT CASE for three piece micro set

INSTRUMENT SETS

MAJOR ORTHOPEDIC SET

OM#	Qty.	Description	OM#	Qty.	Description
OM 29-0059	2	SCALPEL HANDLE #3	OM 46-0453	1	SMITH-PETERSON OSTEOTOME str. 1"
OM 29-0060	1	SCALPEL HANDLE #4	OM 46-0458	1	SMITH-PETERSON OSTEOTOME cvd.3/8"
OM 35-0198	1	WIRE CUTTING SCISSORS 4 3/4"	OM 46-0460	1	SMITH-PETERSON OSTEOTOME cvd.5/8"
OM 35-0212	1	SUPER-CUT LISTER BANDAGE SCISSORS 7 1/4"	OM 46-0462	1	SMITH-PETERSON OSTEOTOME cvd.1"
OM 35-0220	1	SUPER-CUT OPERATING SCISSORS 5 1/2"	OM 46-0466	1	SMITH-PETERSON GOUGE straight 1/4"
OM 35-0292	1	SUPER-CUT MAYO SCISSORS 6 3/4" straight	OM 46-0468	1	SMITH-PETERSON GOUGE straight 1/2"
OM 35-0298	1	SUPER-CUT MAYO SCISSORS 6 3/4" curved	OM 46-0477	1	SMITH-PETERSON GOUGE straight 3/4"
OM 35-0394	1	SUPER-CUT METZENBAUM SCISS. 7" curved	OM 46-0488	1	SMITH-PETERSON GOUGE curved 3/8"
OM 35-0490	1	SUPER-CUT STEVENS SCISSORS 4 1/2" curved	OM 46-0490	1	SMITH-PETERSON GOUGE curved 5/8"
OM 36-0156	12	MOSQUITO FORCEPS 5" straight	OM 46-0493	1	SMITH-PETERSON GOUGE curved 1"
OM 36-0158	12	MOSQUITO FORCEPS 5" curved	OM 46-0565	1	BRUN CURETTE 9" straight #0
OM 36-0166	12	KELLY FORCEPS 5 1/2" straight	OM 46-0566	1	BRUN CURETTE 9" straight #1
OM 36-0168	6	KELLY FORCEPS 5 1/2" curved	OM 46-0567	1	BRUN CURETTE 9" straight #2
OM 36-0186	6	CRILE FORCEPS 6 1/4" straight	OM 46-0568	1	BRUN CURETTE 9" straight #3
OM 36-0188	6	CRILE FORCEPS 6 1/4" curved	OM 46-0569	1	BRUN CURETTE 9" straight #4
OM 36-0318	2	ROCHESTER-PEAN FORCEPS 6 1/4" curved	OM 46-0667	1	ORTHOPEDIC MALLET 10 1/2", 32 oz.
OM 36-0328	2	ROCHESTER-PEAN FORCEPS 7 1/4" curved	OM 47-0526	1	RUSKIN RONGEUR 7 1/4"
OM 36-0426	4	ROCHESTER-OCHSNER FORCEPS 7 1/4" straight	OM 47-0538	1	RUSKIN-LISTON FORCEPS 7 1/2"
OM 36-0746	2	ADSON HEMOSTATIC FORCEPS 7 1/4" curved	OM 48-0343	1	BONE HOOK 9", 11mm x 22mm
OM 37-0386	6	FOERSTER FORCEPS 9 1/2" straight	OM 48-0344	1	BONE HOOK 9", 8mm x 30mm
OM 37-0462	12	BACKHAUS TOWEL FORCEPS 5 1/4"	OM 51-0060	2	HIBBS RETRACTOR 9 1/2"
OM 38-0084	2	DRESSING FORCEPS 5 1/2"	OM 51-0080	2	ISRAEL RETRACTOR 8"
OM 38-0094	2	DRESSING FORCEPS 8"	OM 51-0200	1	RICHARDSON RETRACTOR 9 1/2", 3/4" x 1"
OM 38-0272	2	TISSUE FORCEPS 5 1/2" 1 x 2 teeth	OM 51-0202	1	RICHARDSON RETRACTOR 9 1/2", 1" x 1 1/4"
OM 38-0276	2	TISSUE FORCEPS 6" 1 x 2 teeth	OM 51-0204	1	RICHARDSON RETRACTOR 9 1/2", 1 1/2" x 1 1/2"
OM 38-0280	2	TISSUE FORCEPS 8" 1 x 2 teeth	OM 51-0206	1	RICHARDSON RETRACTOR 9 1/2", 3/4" x 2"
OM 38-0304	2	TISSUE FORCEPS 5 1/2" 3 x 4 teeth	OM 51-0230	1	DEAVER RETRACTOR 1" x 10"
OM 39-0056	2	MICRO ADSON FORCEPS 4 3/4" 1 x 2 teeth	OM 51-0232	1	DEAVER RETRACTOR 1" x 12"
OM 39-0092	2	ADSON BROWN FORCEPS 4 3/4" 9 x 9 teeth	OM 51-0240	1	DEAVER RETRACTOR 2" x 12"
OM 39-0694	1	RULER 8"	OM 51-0372	2	U.S. ARMY RETRACTOR 8"
OM 41-0174	2	CRILE-WOOD NEEDLE HOLDER 6" carbide	OM 51-0521	2	CUSHING VEIN RETRACTOR 9"
OM 41-0175	2	CRILE-WOOD NEEDLE HOLDER 7" carbide	OM 52-0090	2	SENN RETRACTOR 6 1/4", blunt
OM 41-0314	2	MAYO-HEGAR NEEDLE HOLDER 8" carbide	OM 52-0258	2	VOLKMAN RETRACTOR 8 1/2" 2 sharp prongs
OM 42-0824	1	FRAZIER SUCTION TUBE 7 french	OM 52-0264	2	VOLKMAN RETRACTOR 8 1/2" 4 sharp prongs
OM 42-0825	1	FRAZIER SUCTION TUBE 8 french	OM 52-0266	2	VOLKMAN RETRACTOR 8 1/2" 6 sharp prongs
OM 42-0826	1	FRAZIER SUCTION TUBE 10 french	OM 52-0274	2	VOLKMAN RETRACTOR 8 1/2" 4 blunt prongs
OM 43-0124	2	ALLIS TISSUE FORCEPS 7 1/2" 5 x 6 teeth	OM 52-0276	2	VOLKMAN RETRACTOR 8 1/2" 6 blunt prongs
OM 46-0258	1	KEY ELEVATOR 7", 1/4" width	OM 52-0502	2	WEITLANER RETRACTOR 6 1/2" sharp
OM 46-0262	1	KEY ELEVATOR 7 1/2", 1/2" width	OM 52-0768	2	GELPI RETRACTOR 7 1/2"
OM 46-0448	1	SMITH-PETERSON OSTEOTOME str. 1/4"	OM 57-0614	1	FREER ELEVATOR 7 1/2"
OM 46-0450	1	SMITH-PETERSON OSTEOTOME str. 1/2"	OM 58-0088	2	JOSEPH SKIN HOOK 6 1/4" 1 sharp prong
OM 46-0452	1	SMITH-PETERSON OSTEOTOME str. 3/4"	OM 58-0092	2	JOSEPH SKIN HOOK 6 1/4" 2 sharp prongs

MINOR ORTHOPEDIC SET

OM#	Qty.	Description	OM#	Qty.	Description
OM 29-0058	2	SCALPEL HANDLE #3	OM 46-0500	1	HOKE OSTEOTOME 5 1/4" straight 5/16" width
OM 29-0060	1	SCALPEL HANDLE #4	OM 46-0501	1	HOKE OSTEOTOME 5 1/4" curved 3/8" width
OM 35-0198	1	WIRE CUTTING SCISSORS 4 3/4"	OM 46-0502	1	HOKE OSTEOTOME 5 1/4" straight 1/2" width
OM 35-0210	1	SUPER-CUT LISTER BANDAGE SCISSORS 5 1/2"	OM 46-0503	1	HOKE OSTEOTOME 5 1/4" curved 5/8" width
OM 35-0220	1	SUPER-CUT OPERATING SCISSORS 5 1/2"	OM 46-0517	1	BRUN CURETTE 7" #0
OM 35-0298	1	SUPER-CUT MAYO SCISSORS 6 3/4" curved	OM 46-0519	1	BRUN CURETTE 7" #1
OM 35-0394	1	SUPER-CUT METZENBAUM SCISS.7" cvd.	OM 46-0521	1	BRUN CURETTE 7" #2
OM 35-0490	1	SUPER-CUT STEVENS SCISSORS 4 1/2" curved	OM 46-0523	1	BRUN CURETTE 7" #3
OM 36-0156	6	MOSQUITO FORCEPS 5" straight	OM 46-0667	1	ORTHOPEDIC MALLET 11"
OM 36-0158	6	MOSQUITO FORCEPS 5" curved	OM 47-0526	1	RUSKIN RONGEUR 7 1/4" straight
OM 36-0166	6	KELLY FORCEPS 5 1/2" straight	OM 51-0200	1	RICHARDSON RETRACTOR 9 1/2", 3/4" x 1"
OM 36-0168	12	KELLY FORCEPS 5 1/2" curved	OM 51-0202	1	RICHARDSON RETRACTOR 9 1/2", 1" x 1 1/4"
OM 36-0188	2	CRILE FORCEPS 6 1/4" curved	OM 51-0204	1	RICHARDSON RETRACTOR 9 1/2", 1 1/2" x 1 1/2"
OM 36-0318	6	ROCHESTER-PEAN FORCEPS 6 1/4" curved	OM 51-0206	1	RICHARDSON RETRACTOR 9 1/2", 3/4" x 2"
OM 36-0416	2	ROCHESTER-OCHSNER FORCEPS 6 1/4" straight	OM 51-0230	2	DEAVER RETRACTOR 1" x 10"
OM 36-0426	2	ROCHESTER-OCHSNER FORCEPS 7 1/4" straight	OM 51-0372	1	U.S.ARMY RETRACTOR 8" 1 pair
OM 37-0386	6	FOERSTER FORCEPS 9 1/2" straight	OM 51-0521	2	CUSHING VEIN RETRACTOR 9"
OM 37-0458	6	BACKHAUS TOWEL FORCEPS 3 1/2"	OM 52-0088	2	SENN RETRACTOR 6 1/4" sharp
OM 37-0462	6	BACKHAUS TOWEL FORCEPS 5 1/4"	OM 52-0116	1	MEYERDING FINGER RETRACTOR 7" #1
OM 38-0084	2	DRESSING FORCEPS 5 1/2"	OM 52-0118	1	MEYERDING FINGER RETRACTOR 7" #2
OM 38-0094	2	DRESSING FORCEPS 8"	OM 52-0122	1	MEYERDING FINGER RETRACTOR 7" #3
OM 38-0272	2	TISSUE FORCEPS 5 1/2" 1 x 2 teeth	OM 52-0124	1	MEYERDING FINGER RETRACTOR 7" #4
OM 38-0276	2	TISSUE FORCEPS 6" 1 x 2 teeth	OM 52-0128	1	MEYERDING FINGER RETRACTOR 7" #5
OM 38-0280	2	TISSUE FORCEPS 8" 1 x 2 teeth	OM 52-0130	1	MEYERDING FINGER RETRACTOR 7" #6
OM 39-0064	2	ADSON FORCEPS 4 3/4" 1 x 2 teeth delicate	OM 52-0258	1	VOLKMAN RETRACTOR 8 1/2" 2 sharp prongs
OM 39-0092	2	ADSON BROWN FORCEPS 4 3/4" 9 x 9 teeth	OM 52-0262	1	VOLKMAN RETRACTOR 8 1/2" 3 sharp prongs
OM 39-0692	1	RULER 6"	OM 52-0416	1	ALM RETRACTOR 4"
OM 41-0174	2	CRILE-WOOD NEEDLE HOLDER 6" carbide	OM 52-0498	2	WEITLANER RETRACTOR 5 1/2" sharp
OM 41-0302	4	MAYO-HEGAR NEEDLE HOLDER 6" carbide	OM 52-0776	1	GELPI RETRACTOR 3 1/2"
OM 42-0824	1	FRAZIER SUCTION TUBE 7 french	OM 52-0778	1	GELPI RETRACTOR 4 1/2"
OM 42-0825	1	FRAZIER SUCTION TUBE 8 french	OM 57-0614	1	FREER ELEVATOR 7 1/2"
OM 42-0826	1	FRAZIER SUCTION TUBE 10 french	OM 58-0088	2	JOSEPH SKIN HOOK 6 1/4" 1 sharp prong
OM 46-0498	1	HOKE OSTEOTOME 5 1/4" straight 3/16" width	OM 58-0092	2	JOSEPH SKIN HOOK 6 1/4" 2 sharp prongs
OM 46-0499	1	HOKE OSTEOTOME 5 1/4" curved 1/4" width			

LARGE BONE SET

OM#	Qty.	Description	OM#	Qty.	Description
OM 39-0694	1	RULER 8"	OM 47-0098	1	VERBRUGGE BONE FORCEPS 11"
OM 46-0212	1	PERIOSTEAL ELEVATOR 7 1/4" round edge	OM 47-0105	1	BONE HOLDING FORCEPS 6 1/2"
OM 46-0214	1	PERIOSTEAL ELEVATOR 7 1/4" oval edge	OM 47-0107	1	BONE HOLDING FORCEPS 9"
OM 46-0215	1	PERIOSTEAL ELEVATOR 7 1/4" straight edge	OM 47-0366	1	STILLE-LISTON FORCEPS 10 1/2" straight
OM 46-0838	2	HOHMANN RETRACTOR 9" 18mm width	OM 47-0458	1	STILLE-LUER RONGEUR 8 1/2" straight
OM 46-0848	2	HOHMANN RETRACTOR 11" 24mm width	OM 47-0520	1	BEYER RONGEUR 7"
OM 46-0850	2	HOHMANN RETRACTOR 9 1/2" 70mm width	OM 47-0527	1	RUSKIN RONGEUR 7 1/4"
OM 46-0858	2	HOHMANN RETRACTOR 8 1/2" 8mm width	OM 47-0538	1	RUSKIN-LISTON FORCEPS 7 1/2"
OM 46-0880	1	BENNETT RETRACTOR small	OM 48-0204	2	BLOUNT RETRACTOR 10 1/4"
OM 46-0884	1	BENNETT RETRACTOR large	OM 48-0343	1	BONE HOOK 9" 11 x 22mm
OM 46-0892	2	MURPHY-LANE BONE SKID	OM 48-0344	1	BONE HOOK 9" 8 x 30mm
OM 47-0094	1	VERBRUGGE BONE FORCEPS 9 1/2"	OM 49-0630	set	OSTEOTOME, CHISEL AND GOUGE SET
OM 47-0096	1	VERBRUGGE BONE FORCEPS 10 1/4"			

INSTRUMENT SETS

SMALL BONE SET

OM#	Qty.	Description	OM#	Qty.	Description
OM 39-0692	1	RULER 6"	OM 47-0090	1	VERBRUGGE BONE FORCEPS 6"
OM 46-0206	1	PERIOSTEAL ELEVATOR 7 1/4" 3mm width	OM 47-0092	1	VERBRUGGE BONE FORCEPS 7 1/2"
OM 46-0207	1	PERIOSTEAL ELEVATOR 7 1/4" 6mm width	OM 47-0128	1	BONE REDUCTION FORCEPS 6"
OM 46-0830	2	MINI HOHMANN RETRACTOR 6 1/2" 6mm width	OM 47-0410	1	LISTON BONE FORCEPS 5 1/2"
OM 46-0832	2	MINI HOHMANN RETRACTOR 6 1/2" 8mm width	OM 47-0527	1	RUSKIN RONGEUR 7 1/4"
OM 46-0838	2	HOHMANN RETRACTOR 9" 18mm width	OM 47-0534	1	RUSKIN RONGEUR 6"
OM 46-0858	2	HOHMANN RETRACTOR 8 1/2" 8mm width	OM 48-0342	1	BONE HOOK 9"

FOREFOOT SET

OM#	Qty.	Description	OM#	Qty.	Description
OM 29-0058	3	SCALPEL HANDLE #3	OM 46-0631	1	FLUSH WIRE CUTTER 7" carbide
OM 33-0324	1	OPERATING SCISSORS 5 1/2" blunt/blunt	OM 46-0660	1	LUCAE BONE Mallet 8"
OM 34-0258	1	MAYO SCISSORS 5 1/2" curved	OM 46-0832	2	MINI HOHMANN RETRACTOR 6 1/2" 8mm width
OM 34-0462	1	METZENBAUM SCISSORS 6" curved	OM 47-0266	1	BLUMENTHAL RONGEUR 6"
OM 35-0198	1	WIRE CUTTING SCISSORS 4 3/4"	OM 47-0520	1	BEYER RONGEUR 7"
OM 36-0156	4	MOSQUITO FORCEPS 5" straight	OM 47-0555	1	KLEINERT-KUTZ FORCEPS 6"
OM 36-0158	8	MOSQUITO FORCEPS 5" curved	OM 48-0252	1	PLUG CUTTER 4 1/2"
OM 36-0166	1	KELLY FORCEPS 5 1/2" straight	OM 52-0088	2	SENN RETRACTOR 6 1/4" 3 sharp prongs
OM 36-0168	1	KELLY FORCEPS 5 1/2" curved	OM 52-0094	2	RAGNELL RETRACTOR 5 3/4"
OM 36-0176	1	CRILE FORCEPS 5 1/2" straight	OM 52-0417	1	SELF-RETAINING RETRACTOR 4" sharp
OM 36-0178	1	CRILE FORCEPS 5 1/2" curved	OM 52-0492	1	WEITLANER RETRACTOR 4" sharp
OM 36-0406	1	KOCHER FORCEPS 5 1/2" 1 x 2 teeth	OM 57-0614	1	FREER ELEVATOR 7 1/2"
OM 37-0366	1	FOERSTER FORCEPS 7"	OM 58-0068	1	JOSEPH RASP 6 1/4"
OM 37-0462	4	BACKHAUS TOWEL FORCEPS 5 1/4"	OM 58-0076	1	SAYRE ELEVATOR 6 1/2"
OM 39-0060	1	ADSON FORCEPS 4 3/4" serrated	OM 58-0088	2	JOSEPH HOOK 6 1/4" 1 sharp prong
OM 39-0063	1	ADSON FORCEPS 4 3/4" 1 x 2 teeth	OM 58-0092	2	JOSEPH HOOK 6 1/4" 2 sharp prongs
OM 39-0092	2	ADSON BROWN FORCEPS 4 3/4" 9 x 9 teeth	OM 58-0240	2	MALTZ-SEEBURGER RETRACTOR 4 1/2"
OM 39-0682	1	BRUSH FOR INSTRUMENT CLEANING	OM 69-0538	1	NAIL RASP #93
OM 39-0698	1	RULER 12"	OM 69-0544	1	BONE FILE #12A
OM 41-0170	1	CRILE-WOOD NEEDLE HOLDER 6"	OM 69-0547	1	BONE RASP 8 1/2"
OM 41-0278	1	MAYO HEGAR NEEDLE HOLDER 7"	OM 69-0787	1	LOCKE PHALANGEAL FORCEPS 6"
OM 43-0112	2	ALLIS TISSUE FORCEPS 6" 4 x 5 teeth	OM 69-0940	1	BEVELED OSTEOTOME 7" straight 10mm width
OM 46-0258	1	KEY ELEVATOR 7", 1/4" width	OM 69-0946	1	BEVELED OSTEOTOME 7" straight 20mm width
OM 46-0262	1	KEY ELEVATOR 7 1/271/2" width	OM 69-0950	1	BEVELED OSTEOTOME 7" straight 25mm width
OM 46-0540	1	VICKERS EASIDRIVER 5 1/2"	OM 69-0970	1	BEVELED OSTEOTOME 7" curved 5mm width
OM 46-0542	1	VICKERS K-WIRE DISPENSER	OM 69-0975	1	BEVELED OSTEOTOME 7" curved 10mm width
OM 46-0572	1	WIRE EXTRACTION PLIERS 7" carbide			

KNEE SET

OM#	Qty.	Description	OM#	Qty.	Description
OM 29-0058	2	SCALPEL HANDLE #3	OM 46-0262	1	KEY ELEVATOR 7 1/2", 1/2" width
OM 29-0060	1	SCALPEL HANDLE #4	OM 46-0650	1	BONE FILE 9 1/2"
OM 29-0062	1	SCALPEL HANDLE #7	OM 46-0741	1	LOWE-BRECK CARTILAGE KNIFE 10"
OM 35-0210	1	SUPER-CUT LISTER BANDAGE SCISSORS 5 1/2"	OM 46-0762	1	SMILLIE KNIFE 6 3/4" straight
OM 35-0292	2	SUPER-CUT MAYO SCISSORS 6 3/4" straight	OM 46-0766	1	SMILLIE KNIFE 6 3/4" left
OM 35-0298	1	SUPER-CUT MAYO SCISSORS 6 3/4" curved	OM 46-0770	1	SMILLIE KNIFE 6 3/4" right
OM 35-0394	1	SUPER-CUT METZENBAUM SCISS.7" cvd.	OM 46-0772	1	DOWNING CARTILAGE KNIFE 10"
OM 36-0176	4	CRILE FORCEPS 5 1/2" straight	OM 46-0802	1	MARTIN CARTILAGE CLAMP 7 1/4"
OM 36-0186	4	CRILE FORCEPS 6 1/4" straight	OM 46-0818	1	WALTON CARTILAGE CLAMP 8"
OM 36-0408	2	KOCHER FORCEPS 5 1/2" curved	OM 46-0828	1	MARTIN CARTILAGE SCISSORS 8"
OM 36-0416	4	ROCHESTER-OCHSNER FORCEPS 6 1/4"	OM 48-0198	1	SMILLIE KNEE RETRACTOR 5 1/2"
OM 37-0462	6	BACKHAUS TOWEL FORCEPS 5 1/4"	OM 48-0206	2	BLOUNT KNEE RETRACTOR 7"
OM 38-0272	2	TISSUE FORCEPS 5 1/2" 1 x 2 teeth	OM 49-0312	1	ADSON PERIOSTEAL ELEVATOR 6 3/4" curved
OM 38-0304	2	TISSUE FORCEPS 5 1/2" 3 x 4 teeth	OM 51-0372	2	U.S. ARMY RETRACTOR 8" 1 pair
OM 39-0056	2	MICRO ADSON FORCEPS 4 3/4" 1 x 2 teeth	OM 52-0088	2	SENN RETRACTOR 6 1/4"
OM 41-0175	2	CRILE-WOOD NEEDLE HOLDER 7" carbide	OM 52-0258	2	VOLKMAN RETRACTOR 8 1/2" 2 sharp prongs
OM 42-0825	1	FRAZIER SUCTION TUBE 8 french	OM 52-0264	2	VOLKMAN RETRACTOR 8 1/2" 4 sharp prongs
OM 43-0110	4	ALLIS TISSUE FORCEPS 6" 3 x 4 teeth	OM 52-0498	2	WEITLANER RETRACTOR 5 1/2"
OM 46-0258	1	KEY ELEVATOR 7", 1/4" width	OM 57-0614	1	FREER ELEVATOR 7 1/2"

BASIC TOTAL HIP SET

OM#	Qty.	Description	OM#	Qty.	Description
OM 29-0060	2	SCALPEL HANDLE #4	OM 43-0124	2	ALLIS TISSUE FORCEPS 7 1/2" 5 x 6 teeth
OM 29-0062	1	SCALPEL HANDLE #7	OM 46-0359	1	HIBBS OSTEOTOME 9" straight, 1/4" width
OM 35-0292	2	SUPER-CUT MAYO SCISSORS 6 3/4" straight	OM 46-0360	1	HIBBS OSTEOTOME 9" straight, 3/8" width
OM 35-0298	1	SUPER-CUT MAYO SCISSORS 6 3/4" curved	OM 46-0361	1	HIBBS OSTEOTOME 9" straight, 1/2" width
OM 35-0322	1	SUPER-CUT MAYO SCISSORS 9" curved	OM 46-0652	1	PUTTI BONE RASP 12"
OM 35-0394	1	SUPER-CUT METZENBAUM SCISS.7" cvd.	OM 46-0666	1	MALLET 10 3/4"
OM 35-0406	1	SUPER-CUT METZENBAUM SCISS.8" cvd.	OM 46-0836	1	HOHMANN RETRACTOR 9" 10mm
OM 36-0156	6	MOSQUITO FORCEPS 5" straight	OM 46-0848	1	HOHMANN RETRACTOR 11" 22mm
OM 36-0188	6	CRILE FORCEPS 6 1/4" curved	OM 46-0850	1	HOHMANN RETRACTOR 9 1/2" 70mm
OM 36-0338	2	ROCHESTER-PEAN FORCEPS 8" curved	OM 47-0460	1	STILLE-LUER RONGEUR 8 1/2" curved
OM 36-0436	2	ROCHESTER-OCHSNER FORCEPS 8" straight	OM 47-0472	1	STILLE-LUER RONGEUR 9"
OM 36-0746	4	ADSON HEMOSTATIC FORCEPS 7 1/4" curved	OM 47-0520	1	BEYER RONGEUR 7"
OM 37-0386	2	FOERSTER FORCEPS 9 1/2" straight	OM 48-0343	1	BONE HOOK 9" medium
OM 37-0458	6	BACKHAUS TOWEL FORCEPS 3 1/2"	OM 48-0344	1	BONE HOOK 9" large
OM 37-0462	2	BACKHAUS TOWEL FORCEPS 5 1/4"	OM 51-0060	2	HIBBS RETRACTOR medium
OM 38-0272	2	TISSUE FORCEPS 5 1/2" 1 x 2 teeth	OM 51-0212	1	RICHARDSON-EASTMAN RETRACTOR 9 1/2"
OM 38-0304	2	TISSUE FORCEPS 5 1/2" 3 x 4 teeth	OM 52-0264	2	VOLKMAN RETRACTOR 8 1/2" 4 sharp prongs
OM 39-0056	2	MICRO ADSON FORCEPS 4 3/4" 1 x 2 teeth	OM 52-0266	2	VOLKMAN RETRACTOR 8 1/2" 6 sharp prongs
OM 39-0196	2	RUSSIAN FORCEPS 8" OM 39-0694 1 RULER 8"	OM 52-0502	2	WEITLANER RETRACTOR 6 1/2" sharp
OM 41-0175	2	CRILE-WOOD NEEDLE HOLDER 7" carbide	OM 52-0780	1	GELPI RETRACTOR 5 1/2"
OM 41-0314	2	MAYO-HEGAR NEEDLE HOLDER 8" carbide	OM 58-0228	3	YANKAUER SUCTION TUBE 11 1/2"

AMPUTATION SET

OM#	Qty.	Description	OM#	Qty.	Description
OM 29-0060	2	SCALPEL HANDLE #4	OM 46-0640	1	SATTERLEE SAW 9"
OM 42-0834	1	BARON SUCTION TUBE 5 french	OM 46-0654	1	PUTTI BONE RASP 10 1/2"
OM 46-0266	1	KEY PERIOSTEAL ELEVATOR 8 1/4" 1" width	OM 47-0374	1	STILLE-HORSELY FORCEPS 10 1/2" bayonet
OM 46-0365	1	HIBBS OSTEOTOME 9" straight 1" width	OM 47-0402	1	LISTON BONE CUTTING FORCEPS 7 1/2"
OM 46-0598	1	LISTON AMPUTATION KNIFE 6 3/4"	OM 47-0458	1	STILLE-LUER RONGEUR 8 1/2" straight
OM 46-0610	1	GIGLI SAW HANDLES 1 pair	OM 48-0334	1	BONE HOOK 8"
OM 46-0613	3	GIGLI SAW BLADE 12"	OM 52-0266	2	VOLKMAN RETRACTOR 8 1/2" 6 sharp prongs
OM 46-0614	3	GIGLI SAW BLADE 20"	OM 58-0228	1	YANKAUER SUCTION TUBE 11 1/2"

SHOULDER SET

OM#	Qty.	Description	OM#	Qty.	Description
OM 46-0848	1	HOHMANN RETRACTOR 11" 22mm width	OM 46-0916	1	PENETRATING AWL 9 1/4" curved
OM 46-0892	1	MURPHY BONE SKID 12"	OM 46-0917	1	SUTURE PASSER 9 1/4" curved, crochet hook
OM 46-0902	1	DARRACH ELEVATOR 10 1/4" 1/2" width small	OM 46-0918	1	SUTURE PASSER 9 1/4" curved with hole
OM 46-0903	1	DARRACH ELEVATOR 10 1/4" 3/4" width medium	OM 46-0919	1	PENETRATING GOUGE 8 1/2" 3mm width
OM 46-0904	1	DARRACH ELEVATOR 13 3/4" 1" width large	OM 48-0226	1	LAMINA SPREADER 10 1/2" flat blades
OM 46-0906	1	FUKUDA STYLE SHOULDER RETRACTOR 7" 38mm width	OM 48-0333	1	VOLKMAN BONE HOOK 9" blunt tip
OM 46-0907	1	FUKUDA STYLE SHOULDER RETRACTOR 7" 32mm width	OM 49-0460	1	CONE RING CURETTE 9" angled #3,3mm
OM 46-0908	1	CAPSULE RETRACTOR 10" 3 sharp prongs	OM 51-0202	1	RICHARDSON RETRACTOR 9 1/2", 1" x 1 1/4"
OM 46-0911	1	GLENOID PERFORATING FORCEPS 6 1/2" slight angle	OM 51-0204	1	RICHARDSON RETRACTOR 9 1/2", 1 1/2" x 1 1/2"
OM 46-0912	1	GLENOID PERFORATING FORCEPS 6 1/2" strong angle	OM 51-0206	1	RICHARDSON RETRACTOR 9 1/2", 3/4" x 2"
OM 46-0913	1	PERCUSSION AWL 8 1/2" curved small	OM 52-0474	1	ADSON RETRACTOR 12 1/2" 4 x 5 blunt
OM 46-0914	1	PERCUSSION AWL 8 1/2" curved medium	OM 52-0770	1	GELPI RETRACTOR 7 1/2" blunt tips
OM 46-0915	1	PERCUSSION AWL 8 1/2" curved large			

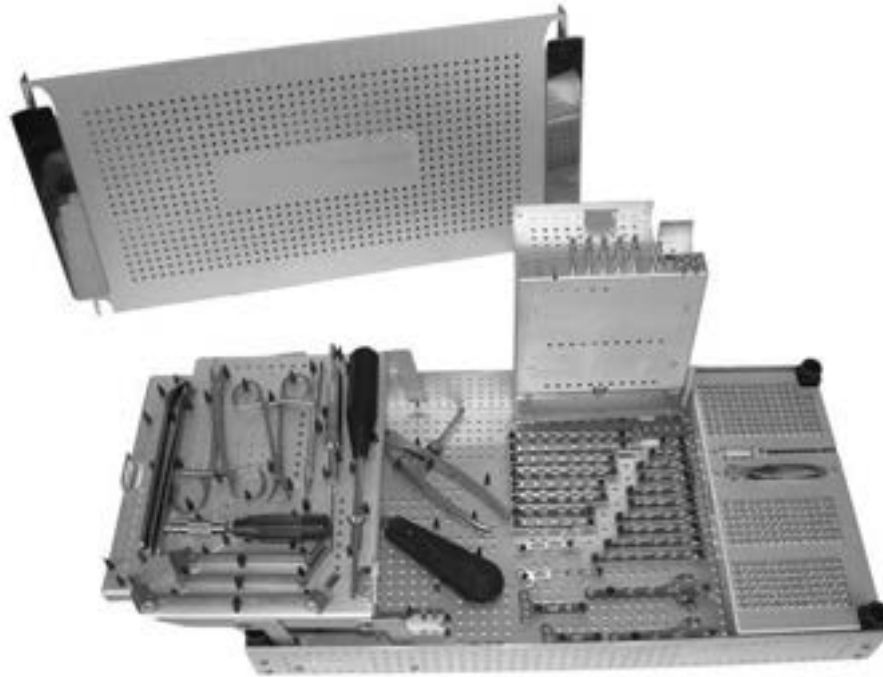

BASIC INSTRUMENTS SET FOR SCREWS AND PLATES

45mm and 6.5mm screws

OM#	Qty.	Description	Optional		
OM 45-0120	1	BENDING TEMPLATE 7 HOLE 4.5mm	OM 45-0118	1	BENDING TEMPLATE 5 HOLE 4.5mm
OM 45-0122	1	BENDING TEMPLATE 9 HOLE 4.5mm	OM 47-0096	1	VERBRUGGE FORCEPS 10 1/2"
OM 45-0124	1	BENDING TEMPLATE 12 HOLE 4.5mm	OM 47-0105	1	BONE HOLDING FORCEPS 7"
OM 45-0210	1	SCREWHOLDING FORCEPS 3 1/2"	OM 47-0137	1	BONE REDUCTION FORCEPS 5 1/4"
OM 47-0094	1	VERBRUGGE FORCEPS 9 1/2"	OM 47-0940	1	LARGE SCREW DEPTH GAUGE 100mm
OM 47-0098	1	VERBRUGGE FORCEPS 11"	OM 47-0954	1	SCREWDRIVER HEXAGONAL 3.5mm 4 1/2" QC
OM 47-0107	2	BONE HOLDING FORCEPS 9 1/2"			
OM 47-0134	1	BONE REDUCTION FORCEPS 8"			
OM 47-0880	1	SHARP HOOK 6"			
OM 47-0911	1	TENSION DEVICE ART. 3 1/2", Span 20mm			
OM 47-0912	1	SOCKET WRENCH 7 1/2", 11mm Chrome			
OM 47-0913	1	COMBINATION WRENCH 6", 11mm, Chrome			
OM 47-0926	1	COUNTERSINK 7", 4.5mm Tip			
OM 47-0935	1	DEPTH GAUGE 120mm			
OM 47-0960	1	T-HANDLE QUICK COUPLING			
OM 47-0961	1	LARGE HEX PELVIC SCREWDRIVER SHAFT QC			
OM 47-0965	1	6.5mm/3.2mm DOUBLE DRILL SLEEVE			
OM 47-0967	1	4.5mm/3.2mm DOUBLE DRILL SLEEVE			
OM 47-0973	1	INSERT DRILL SLEEVE 4.5mm/3.2mm			
OM 47-0980	1	DRILL GUIDE NEUTRAL + LOAD 3.2/4.5mm			
OM 47-0983	1	SLEEVE F. SCREWDRIVER 47-0954			
OM 47-0985	1	4.5mm UNIVERSAL DRILL GUIDE			
OM 48-0054	2	DRILL BIT QC 2.0mm, 100/75mm			
OM 48-0061	3	DRILL BIT QC 3.2mm, 145/120mm			
OM 48-0067	2	DRILL BIT QC 4.5mm, 145/120mm			
OM 48-0118	3	TAP 4.5mm 5" Medium thread			
OM 48-0122	1	TAP 6.5mm 8" Calibrated in cm			
OM 48-0349	1	SCREWDRIVER HEXAGONAL 10" 3.5mm with notch			

PELVIC INSTRUMENT SET

OM#	Qty.	Description
OM 45-0210	1	SCREWHOLDING FORCEPS 3 1/2"
OM 45-0310	1	ASYMMETRIC PELVIC REDUCTION FORCEPS
OM 45-0312	1	PELVIC REDUCTION FORCEPS 200mm with Pointed-Ball tips
OM 45-0314	1	PELVIC REDUCTION FORCEPS 240mm with Pointed-Ball tips
OM 47-0100	1	PELVIC REDUCTION FORCEPS used with screws
OM 47-0101	1	PELVIC REDUCTION FORCEPS 400mm 1 X 2 Pointed-Ball tips
OM 47-0102	1	PELVIC REDUCTION FORCEPS 250mm with angled Pointed-Ball tips
OM 47-0103	1	PELVIC REDUCTION FORCEPS 400mm with Pointed-Ball tips
OM 47-0134	1	REDUCTION FORCEPS with POINTS 205mm Ratchet
OM 47-0190	1	FARABEUPELVIC FORCEPS 190mm
OM 47-0192	1	FARABEUPELVIC FORCEPS 250mm
OM 47-0906	1	STRAIGHT BALL SPIKE
OM 47-0919	2	BENDING IRON FOR 3.5mm & 4.5mm RECON. PLATES
OM 47-0921	4	SPIKED DISK
OM 47-0927	1	BENDING PLIERS F. RECONSTR. PLATES 10"
OM 47-0935	1	DEPTH GAUGE 120mm
OM 47-0946	1	BENDING TEMPLATE 22 F. 3.5mm CVD. RECON. PLATES
OM 47-0947	1	BENDING TEMPLATE 22 F. 3.5mm RECON. PLATES
OM 47-0948	1	BENDING TEMPLATE 16mm F.4.5mm RECON. PLATES
OM 47-0951	1	SMALL HEXAGONAL PELVIC SCREWDRIVER SHAFT QC
OM 47-0960	1	T-HANDLE QUICK COUPLING
OM 47-0961	1	LARGE HEXAGONAL PELVIC SCREWDRIVER SHAFT QC
OM 47-0979	2	3.2mm CALIBRATED THREE-FLUTE DRILL 230/205mm QC
OM 47-0981	2	4.5mm THREE-FLUTE DRILL 195/170mm QC
OM 47-0983	1	SLEEVE F. SCREWDRIVER OM 47-0954
OM 47-0986	2	2.5mm CALIBRATED THREE-FLUTE DRILL 230/205mm QC
OM 48-0050	2	3.5mm DRILL BIT 195mm/170mm QC
OM 48-0068	2	DRILL BIT QC 4.5mm, 195/170mm XLNG
OM 48-0102	2	TAP CALIBRATED FOR 4.5mm CORTEX SCREWS 180/155mm
OM 48-0104	2	TAP CALIBRATED FOR 3.5mm CORTEX SCREWS 175/150mm
OM 48-0201	1	BLUNT PELVIC RETRACTOR
OM 48-0331	1	VOLKMAN BONE HOOK 10 1/4"
OM 48-0332	1	BONE HOOK LARGE 7" Sharp
OM 48-0353	1	LARGE HEX PELVIC SCREWDRIVER 12"
OM 48-0364	1	SMALL HEX PELVIC SCREWDRIVER
OM 48-0365	1	SLEEVE ONLY FOR OM 48-0348/48-0364/48-0368
OM 48-0374	1	UNIVERSAL CHUCK with T-Handle

SMALL SCREW FIXATION SET FOR OFFICE AND SURGERICENTER

2.7mm, 3.5mm and 4.0mm

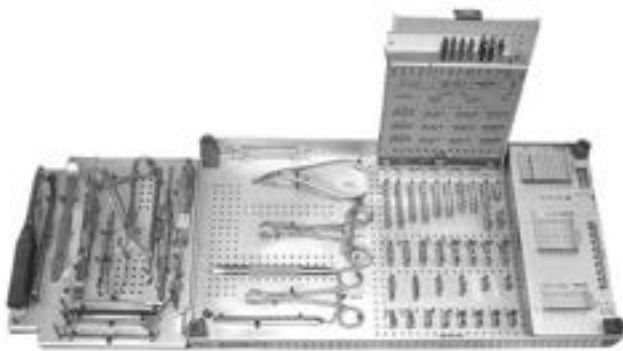

Compact Size

Fits into autoclaves. Autoclaves individually or stacked.

Clear Graphics

Quick reference chart makes set-up, use, and reordering easy.

Lightweight and Portable

Easily transportable between operating sites. Precise placement of contents keeps each item securely in place.

SMALL FRAGMENT SCREW FIXATION SET WITH 2 TRAYS

OM 48-0410

OM#	Qty.	Description
OM 47-0137	1	BONE REDUCTION FORCEPS, Pointed 5 1/4"
OM 47-0880	1	SHARP HOOK 6"
OM 47-0128	1	BONE REDUCTION FORCEPS 6" curved jaw
OM 48-0054	1	DRILL BIT 2.0mm, 100mm
OM 48-0057	1	DRILL BIT 2.5mm, 110mm
OM 48-0058	1	DRILL BIT 2.7mm, 100mm
OM 48-0063	1	DRILL BIT 3.5mm, 110mm
OM 47-0922	1	COUNTERSINK SMALL 2.0mm, 2 3/4"
OM 48-0110	1	TAP 2.7mm, 4"
OM 48-0112	1	TAP 3.5mm, 5" fine thread
OM 48-0114	1	TAP 3.5mm, 4 1/2" 1.75mm fine thread
OM 47-0904	1	QUICK COUPLING HANDLE 4 1/2" small
OM 47-0970	1	DRILL GUIDE FOR 2.0mm DRILL, 4 1/4"
OM 47-0972	1	TAP SLEEVE 2.5mm DRILL & 3.5mm SCREW, 5"
OM 47-0974	1	INSERT DRILL SLEEVE 3.5/2.7mm, 1 1/2"
OM 47-0953	1	SCREWDRIVER BIT 2.5mm, 4"
OM 47-0955	1	SLEEVE FOR SCREWDRIVER OM 47-0953, 2"
OM 47-0936	1	DEPTH GAUGE 50mm
OM 48-0412	1	INSTRUMENT TRAYS

Trays are made of lightweight anodized aluminum.

BASIC SCREW SET

OM 73-0001

Includes: 2 trays with cover.
1 OM 47-0930 Screw Holding Forceps

Trays accommodate 6 each of 1.5mm through 4.0mm screws.

Screws are not included with trays. They can be ordered separately.

For our complete selection of screws refer to section T.

Dimensions: Tray 1: 9" x 5" x 1 1/2"

Tray 2: 9" x 5" x 2 1/2"

All four combined: 9"x5"x7"

Metric to Metric Conversions

to convert	to	multiply by
millimeters (mm)	centimeters (cm)	0.1
millimeters (mm)	meters (m)	0.001
centimeters (cm)	millimeters (mm)	10
centimeters (cm)	meters (m)	0.01
meters (m)	millimeters (mm)	1.000
meters (m)	centimeters (cm)	100
grams (g)	kilograms (kg)	0.001
Kilograms (kg)	grams (g)	1.000

English to Metric Conversions

to convert	to	multiply by
inches	millimeters (mm)	25.4
inches	centimeters (cm)	2.54
millimeters (mm)	inches	0.0394
centimeters (cm)	inches	0.394
ounces (oz)	grams (g)	28.3
pounds (lbs)	kilograms (kg)	0.454
grams (g)	ounces (oz)	0.035
kilograms (kg)	pounds (lbs)	2.20

Fractions to Millimeters

inch	millimeters
1/16	1.59
1/8	3.18
3/16	4.74
1/4	6.35
5/16	7.94
3/8	9.53
7/16	11.11
1/2	12.70
9/16	14.29
5/8	15.88
11/16	17.46
3/4	19.05
13/16	20.64
7/8	22.23
15/16	23.81
1	25.40

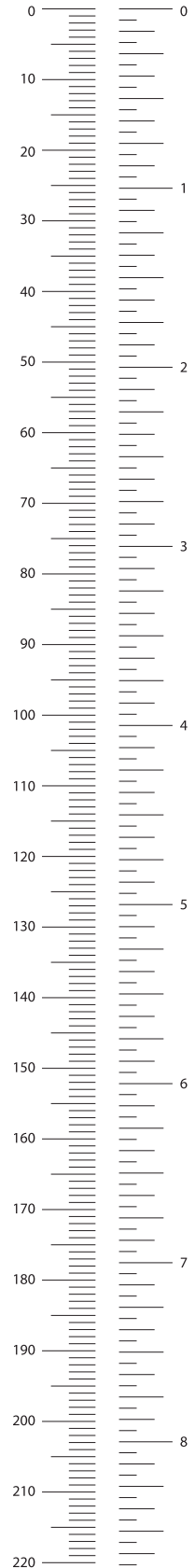

French Scale fr/mm

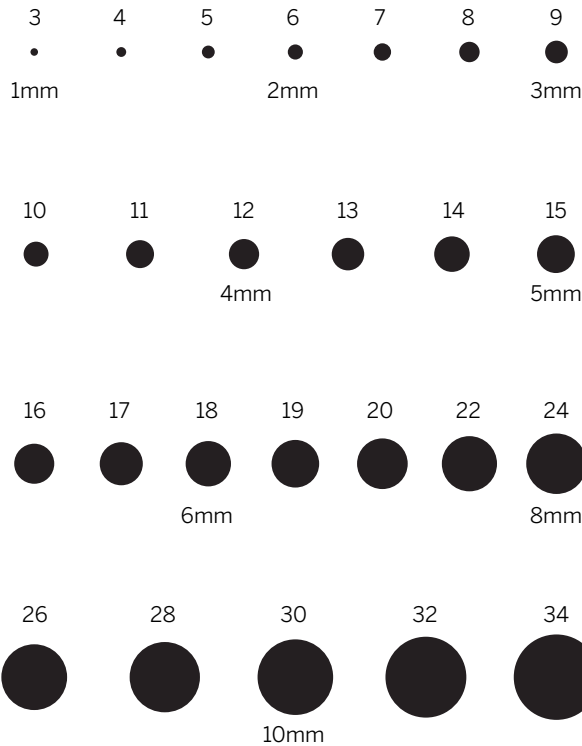

French Scale fr/mm

inch	millimeters
3 fr	1.0mm
4 fr	1.3mm
5 fr	1.7mm
6 fr	2.0mm
7 fr	2.3mm
8 fr	2.7mm
9 fr	3.0mm
10 fr	3.3mm
11 fr	3.7mm
12 fr	4.0mm
13 fr	4.3mm
14 fr	4.7mm
15 fr	5.0mm
16 fr	5.3mm
17 fr	5.7mm
18 fr	6.0mm
19 fr	6.3mm
20 fr	6.7mm
22 fr	7.3mm
24 fr	8.0mm
26 fr	8.7mm
28 fr	9.3mm
30 fr	10.0mm
32 fr	10.7mm
34 fr	11.3mm

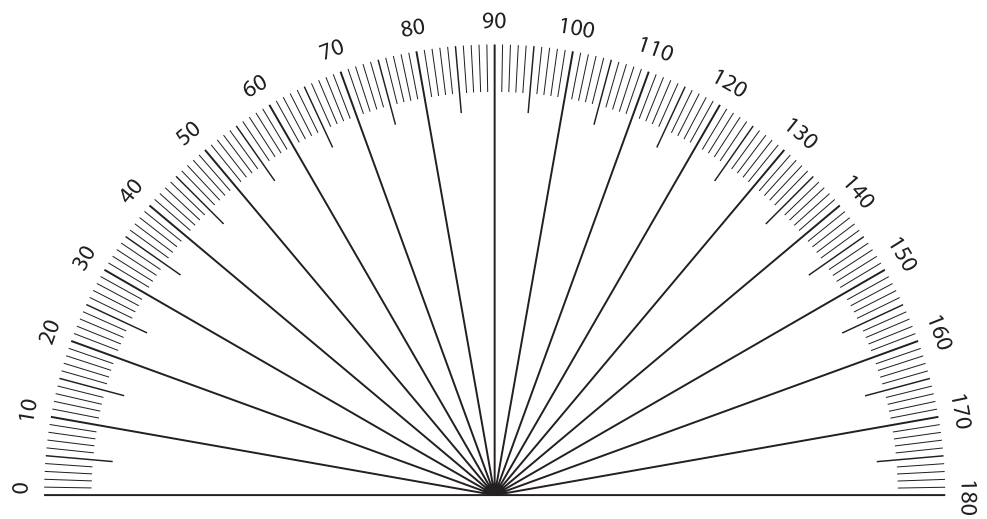
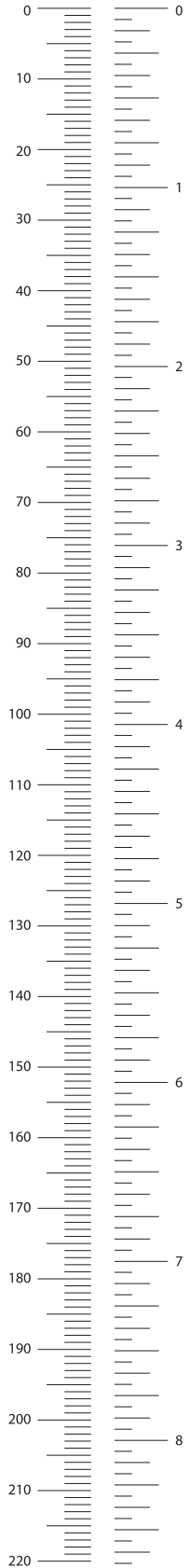

Angle Chart

Jaw curvature and jaw angles are measured in degrees.
Use the angle chart to determine the instrument's degree of curvature.

ALPHABETICAL INDEX



3 lb Mallet	K6	Basket Punch Duckbill	Q6	Bone Fixator	L20
5lb Mallet	K6	Bayonet, Knife	Q1	Bone Forceps w/Drill Guide	U19
— A —					
Accessories Case	I58	Bayonet Tissue Forceps	A27	Bone Forceps w/Speed Lock	L6
Access Mis Retractor Set	X4	Beckman Retractors	I38, I45-I47	Bone Forceps w/K-Wire Guide	L6
Acetabular Retractor	I17	Beckman-Adson Retractor	I46	Bone Forceps, Littauer	M1
Adaptor For Power Drill	U3	Beckman-Eaton Retractor	I45	Bone Fragment Clamp	L6a
Adson Bayonet Forceps	A27	Beckman-Weitlaner Retractor	I38	Bone Graft Tamp	K8-K9
Adson Brown Forceps	A25	Belepahroplasty Scissors	A12	Bone Grafting Retractor	I39
Adson Dressing Forceps	A24	Bending Irons	U21	Bone Holding Forceps	L4-L8, U19-U20
Adson Dressing Micro	A24	Bending Pliers	U22	Bone Holding Forceps w/Fenestration	L5
Adson Elevator	G5	Bending Press	U23	Bone Holding w/Swivel Head	L16
Adson Forceps	A24-A27	Bending Templates	U18-U19	Bone Hooks	G18
Adson Hemostatic Forceps	A18	Bennett Bone Elevator & Retractor	I16	Bone Impactor	K8
Adson Periosteal Elevator	G5	Bent Hohmann	I31 b, X4	Bone Knives	M7
Adson Retractors	I39, I47	Bergman Mallet	K4	Bone Mallet, Lucae	K1
Adson Rongeur	N7	Bertha Hip Retractor with Handle	I18	Bone Mallets	K1-K6
Adson Tissue Forceps	A25	Beyer Rongeur	N5	Bone Mill	M9
Alexander Chisel	J5	Biro Dermal Naevus Scissors	A9, D11	Bone Pins	R9
Alexander Gouge	J5	Bishop Bone Holding Forceps	L17	Bone Plates	T11-T20
Alexander Raspatory	G5	Bit, Screwdriver U10 Bite Styles	O1	Bone Rasp #64	F1
Allerdyce Elevator	G1	Bits, Drill	U1	Bone Rasp	F4
Allis Tissue Forceps	A19	Blade and Accessories Case	I58	Bone Rasps	Section F
Allis-Judd Tissue Forceps	A20	Blade Retractor	I6	Bone Reduction Forceps	L4-L6a, U20
Alm Retractor	I34	Blades, Chisel	J1	Bone Saws	M5-M6
Aluminum Bending Template	U18-U19	Blades, Gigli Saw	M7	Bone Scraper	M9
Aluminum Caliper	W2	Blades, Gouge	J1	Bone Screw & Plate Instr	Section U
Amputation Knife	M7	Blades, Kelly	I57	Bone Screws	T1-T10
Amputation Set	BB15	Blades, Osteotome	J1	Bone Skid	I9
Amputation Shield	M6	Blair Retractor	I2	Bone Tamp, Endoscopic	K7
Army Pattern Chisel	J5	Blepharoplasty Scissors	A12	Bone Tamp	K7-K8, K10
Army Pattern Gouge	J5	Blount Retractors	I26	Bone Wire Set	BB7-BB10
Army Pattern Osteotome	J4	Blumenthal Rongeur	N2	Brand Tendon Pulling Forceps	P2
Army Retractor	I9	Bodner Retractor Narrow	I31a	Braun Episiotomy Scissors	A7
Arthroscopic Instruments	Section Q	Boehler Plaster Breaker	E4	Breaker, Plaster Cast	E3-E4
Arthroscopic Scissors	Q2-Q8	Boehler Tractor	S32	Bristow/Bankart Retractor	I19
Arthroscopic Punches	Q2-Q8	Bone And Plate Holding Fcps	L1-L8	Broad Plates	T20
Articulated Ten. Device	U16	Bone Awls	G17	Brown Needle Holder	A30
Asymetric Pelvic Red. Forceps	L9	Bone Chip Packer	K7	Browne Deltoid Retractor	I19
Atraumatic Forceps	A26	Bone Clamps	L11-L20	Brun Curette	H3
Aufracht Cobra Retractor	I16	Bone Compass	W1	Brun Curette, Endoscopic	H7
Aufricht Rasp	F5	Bone Curettes	Section H	Brun Rack	AA2
Awls	G17-18	Bone Cutting Forceps	M1-M5	Bruns Shears	A13, E2
— B —					
Babcock Forceps	A20	Bone Cutting Instruments	Section M	Brushes, Cleaning	Y4-Y5
Baby Allis	A19-A20	Bone Cutting Rongeurs Section	N	Buck Neurological Hammer	A36
Baby Metz. Scissors, Super-Cut	A1	Bone Cutting, Liston	M2-M4	Bunnell Drill	S5
Backhaus Towel Forceps	A22	Bone Cutting, Ruskin	M2-M3	Bunnell Tendon Stripper	P5
Backhaus-Roeder Towel Clamp	A22	Bone Cutting, Stille-Horsley	M4	Bunt Forceps Holder	Z2
Bacon Rongeur	N6	Bone Cutting, Stille-Liston	M4	Buried Wire Set	BB10
Balfour Retractors	I49	Bone Elevator	I16	Burrs	S9
Ball Spike	U16	Bone File #10	F2	— C —	
Banana Knife	Q1	Bone File #12	F2	"C" Retractor	I32
Bandage Scissors	A12-A13	Bone File #12a	F3	Cable Cutter	S19
Bandage Scissors, Super-Cut	A3	Bone File #12ca	F3	Calcaneal Spreader	D12,I59
Bane Rongeur	N6	Bone File #33	F3	Calibrated Osteotome	J2-J3
Bankart Retractor	I19	Bone File #45	F3	Calibrated Taps	U4
Baron Suction Tube	A33	Bone File #92a	D8, F1	Caliper, Aluminum	W2
Basic Instrument Screw Set	BB4, BB16	Bone File #92b	D8, F1	Caliper, Castroviejo	W2
Basic Screw Tray	BB4	Bone File #93	F1	Caliper, Neuro	W2
Basic Total Hip Set	BB15	Bone File, Large	F6	Canal Finder Rasp	F8
		Bone File	F6-F7	Cancellous Bone Screws	T1-T8
		Bone Files	Section F	Cannulated Drill Bits	U2

Cannulated Pin Cutter	S12	Cobb Rack	AA2	Deaver Scissors	A4
Cannulated Wire Passer	S32	Cobb-Type Spinal Gouge	J11	Deba key Atraumatic Forceps	A26
Capsule Retractor	I19	Cobra Retractor	I16	Debakey Needle Holder	A31
Capsule Scissors	P1	Collateral Retractor	X1	Debakey Tissue Forceps	A26
Carbide Needle Holders	A29-A32	Collateral Ligament Ret. Long Prong	I31 b	Decker Ivd Rongeur	O8
Carlson Pronator Retractor	I31c1	Collateral Soft Tissue Retractor	X3	Deep Blade Small Weitlaner Retractor	I60
Carmalt Splinter Forceps	A28	Collier Needle Holder	A30	Deep Angle Retractor	I52a
Caron Tendon Pulling Fcps	P3	Collin Mallet	K2	Deep Rake ReHohman Retractor	I17
Carroll Periosteal Elevator	G8	Combination Mallet	K3	Delicate Wire Cutter	S10
Cartilage and Bone Clamp	L1	Combination Wrench	U17	Deltoid Retractor	I22
Cartilage File	Q1	Comedone Extractors	D10	Demel Wire Guide	S32
Cartilage Instruments	Section P	Compass, Bone	W1	Depth Gauges	U5,W1
Cartilage Knife	P5	Compression Plate	T13-T14	Derf Needle Holder	A30
Cartilage Scissors	P1	Compression Plates, Broad	T20	Deschamps Ligature Carrier	A38
Case, Blade and Accessories	I58	Compression Plates, Narrow	T19	Diamond Pin Cutter	S11
Case, Table Fixation and Ring	I58	Cone Ring Curette	H6	Dilators	I51
Caspar Ivd Rongeur	O5	Cone Ring Curette, Endo	H8	Dingman Cartilage And Bone Clamp	L1
Caspar Distractor Left	I52c	Containers, Sterilizing	Y1-Y3	Dingman Forceps	P1
Caspar Distractor Right	I52c	Containers, Storage	Section AA	Dispenser, K-Wires	S1
Cast Breaker	E4	Corn Knife	D9	Dispenser, Steinmann Pin	S1
Cast Spreader	E4	Cortex Self-Tapping Screws	T8-T10	Dissecting Scissors	A4-A9
Castroviejo Caliper	W2	Cortical Bone Screws	T1-T6	Distraction Screws	I52d
Castroviejo Needle Holder	A32	Corwin Wire Twister	S31	Doan Knee Retractor	I24
Cement Grasper	P6	Cottle Rasp	F4	Double Action Bone Cutter	M2-M4
Cerclage Wire	R3	Cottle Skin Hook	I1	Double Action Pin Cutter	S15
Cerclage Wire Cutters	S10-S11	Countersinks	U3	Double Action Pliers	S24
Cerclage Wire Pliers	S20-S21	Coupling Bow	58	Double Action Wire Cutter	S13
Cerebellum Retractor	I40	Cox Metatarsal Spreader	D12,I49	Double Action Wire Extraction Pliers	S24
Cervical Lamina Spreader	I44	Crego Elevator	G9	Double Bend Hohman Retractor	I31a
Cervical Micro Curette	H11	Crile Forceps	A17	Double Bent Hohman Retractor	I31a
Cervical Driver & Impactor	K9	Crile Retractor	15	Double Drill Sleeves	U6
Cervical Punches	D15	Crile-Wood Needle Holder	A31	Double Ended Curettes	H1-H2
Cervical Retractor Set	I44	Crown Fixator	L20	Double-Sided Brush	Y4
Chandler Elevator	G10	Cruciform Screwdrivers	U12	Downing Cartilage Knife	P5
Chandler Retractor	G10	Crutchfield Tongs	I42	Doyen Abdominal Scissors	A5
Charriere Bone Saw	M6	Curette #8	H5	Doyen Clamp	A20
Chichirelli Rongeur	N2	Curette Excavator	D7-D8	Dressing Forceps	A23, A27
Chip Packer	K7	Curette Excavator (Verucca)	D8	Dressing Forceps, Micro	A24
Chisel, Alexander	J5	Curette, Ring	H5, Q1	Drill Bits	S9, U1
Chisel Blades	J1	Curettes, Bone Section	H	Drill, Hudson	S9
Chisel, Hibbs	J9	Cushing Bayonet Forceps	A27	Drill Guides	S8, U7-U9
Chisel, Hoke	J4	Cushing Decompression Retractor	I7	Drill, Kirschner	S8
Chisel, Lexer	J6	Cushing Drill Bit	S9	Drill Sleeve For Tension Dev	U15
Chisel, Lexer Mini	J6	Cushing Ivd Rongeur	O4	Drill Sleeves	U6-U7
Chisel, Mini	J6	Cushing Periosteal Elevator	G3	Drills, Hand	S5-S9
Chisel, Stille-Type	J8	Cushing Tissue Forceps	A27	Drivers, Lumbar/Cervical	K9
Chisels	Section J	Cushing Vein Retractor	I7-I8	Drying Trays	Y7
Chuck, Jacobs Universal	U14	Cuticle Nipper	D5	Duckbill Rongeur	N7-N9
Chuck, Universal	S2	Cutter, Delicate Wire	S10	Dural Hook	I1-I2
Chuck & Key	S8				
Clamps, Johns Hopkins Bulldog	A16	- D -		- E -	
Cleaning Brushes	Y4-Y5	D'errico Drill Bit	S9	Easidriver, Vickers	S2
Clean Wave Kerrison Rongeur	O20	D'errico-Adson Retractor	I40	Eastmann Retractor	I15
Cleveland Cutting Forceps	M1	Dale Thoracic Rongeur	N10	Easy Clean Depth Guage	W4
Cloverleaf Plates	T14	Dandy Nerve Hook	I7	Echlin Duckbill Rongeur	N7
Cloward Blade Retractor	I6	Darrach Elevator	G9	Edna Towel Clamp	A23
Cloward Lamina Spreaders	I43	Davis Retractor	I4	Elevators	G1-G16
Cloward Mallet	K3	Debriderment Pan	Y13	End Cutter	S11, S14
Cobb Curette	H5	Dead Blow Mallet	K5	Endaural Retractor	I37
Cobb Elevators	G11-G13	Dean Rongeurs	N2	Endo Ferris-Smith Rongeur	O11
Cobb Osteotome	J10	Deaver Retractor	I11-I13	Endoscopic Bone Tamp	K7
		Deaver Retractor, Pediatric I	12	Endoscopic Brun Curette	H7

Endoscopic Cobb Elevator	G13	Flush Wire Cutter	S12	Graft, Bone Tamp	K8-K9
Endoscopic Cone Ring Cur	H8	Foerster Sponge Forceps	A23	Gratloch™ Wire Bender	S4
Endoscopic Curettes	H7-H8	Fomon Rasp	F5	Green Retractor	I6
Endoscopic Elevators	G12-G14	Foramenotomy Punch	O16	Greg Comedone Extractor	D10
Endoscopic Epstein Curette	H7	Forceps	A15-A29	Grooved Directors	A36
Endoscopic Hibbs Gouge	J12	Forceps Holder	Z2	Guide Wires	R3
Endoscopic Hibbs Osteotome	J12	Forceps, Bone Cutting	M1-M5	Guthrie Hook	I1
Endoscopic Ivd Rongeur	O11	Forceps, Bone Holding	L1-L17	— H —	
Endoscopic Kerrison Punch	O18	Forceps, Kelly	A16	Halsey Needle Holder	A29
Endoscopic Nerve Probe	G2	Forceps, Plate Cutting	S20	Halsted Mosquito Forceps	A16
Endoscopic Osteotome	J12	Forceps, Plate Holding	L1-L2	Hammers	A36
Endoscopic Penfield Elev	G3	Forceps, Screw Removal	S23	Hand Drills	S5-S9
Endoscopic Scoville Cur	H8	Forceps, Wire Pulling	S29	Hand Instruments	Section D
Endotracheal Forceps	A22	Forceps, Wire Twisting	S29-S31	Hand Retractor, Vickers	I33
Engel Plaster Saw	E3	Forearm Retractor	I33	Hand Retractors	I3-4, I28, I33
English Anvil Nail Forceps	D5	Forefoot Instrument Set	BB14	Hand-Held Rod Cutter	S18
Epistomy Scissors	A7	Fox Curette	D11	Handle, Rongeurs	O2-O3
Epstein Curette	H3	Fracture Hook	U15	Handles, Quick Coupling	U5
Epstein Curette, Endo	H7	Fragment Fixation Set	BB18	Handles, Scalpel	A34-A35
Esmarch Shears	A13, E3	Fragment Plate	T12	Hartmann Mosquito Forceps	A15
Excavator And Packer	D7	Frazier Hook	I1	Hartmann Rongeur	N6
Excavator And Probe	D7	Frazier Laminectomy Retr	I42	Haverfield-Scoville Retr Set	I50
Extension Piece	S9	Frazier Suction Tube	A33	Hayes Hand Retractor	I28
Eye Dressing Forceps	A26	Freer Elevator	G1	Heath Mallet	K4
— F —		Freer Skin Hook	I2	Heavy Duty Pliers	S25
Farabeuf Bone Holding Fcps	L17	French Rod Bender	U25	Heavyweight Mallet	K4-K5
Farabeuf Raspatory	G4	Freund Small Joint Reduction Clamp	L13	Hegar Needle Holder	A29, A31
Feilchenfeld Forceps	A28	Friedman Rongeur	N1	Heiss Retractor	I34
Felt Scissors	D6	Friedman Rongeur, Mini	N2	Hemilaminotomy Retractor	I50
Ferguson Angiotribe Forceps	A18	Front And Side Cutter	S12	Hemostatic Forceps	A15-A19
Ferguson Scissors	A6	Fukuda Shoulder Retractor	I20	Hemostatic Forceps, Micro	A15
Fergusson Bone Forceps	L7	Fukushima Suction Tubes	A33	Heniscal Clamp	P2a
Femoral Head Elevator	G12b	— G —		Hennig Plaster Spreader	E5
Femoral Neck Elevator	I18	Gauge, Depth	U5,W1	Hercules Scissors	A14, E2
Femoral Tibial Spreader	I59,I60	Gauge, K-Wire and Pin	W3	Hercules Wire Cutter	S14
Femoral Tibial Spreader 10"round disks	I59	Gelpi Retractors	I36	Hercules Front and Side Cutter	S14
Femoral Tibial Spreader 7"round disks	I59	Gelpi-Seletz Retractor	I36	Hex Keys	U17
Femoral Tibial Spreader dia.cut pads	I60	Gerald Dressing Forceps	A27	Hexagonal Screwdriver	U10-U13
Ferriera Style	I54	Gerzog Bone Mallet	K1	Hibbs-Brun Rack	AA1
Ferris Smith Kerr Punch Endo	O18	Gigli Saw Blades	M7	Hibbs Blades	I50
Ferris Smith Kerrison Punch	O15	Gigli Saw Handles	M7	Hibbs Chisel	J9
Ferris Smith Kerrison Rongeur	O19	Gillies Hook	I2	Hibbs Gouge	J9
Ferris Smith Kerrison Rongeur TFP	O19	Gillies Needle Holder	A31	Hibbs Gouge, Endoscopic	J12
Ferris-Smith Ivd Rongeur	O6	Glenoid Perforating Fcp	L5	Hibbs Osteotome	J8
Ferris-Smith Ivd Rongeur, Endo	O11	Goelet Retractor	I9	Hibbs Osteotome, Endo	J12
Ferris-Smith Tissue Forceps	A23	Gold Cut Hercules Wire Cutter	S14a	Hibbs Retractor	I10
Fibula Forceps	L3	Golf Stick Knife	D9	Hi-Level Bandage Scissors	A13
Files, Bone	Section F	Goniometer, Polk Finger	W2	Hi-Level Bandage Scissors, Super-Cut	A3
File, Cartilage	Q1	Gouge, Alexander	J5	Hill Stitch Scissors	A10
Fine Mesh Baskets	Y12	Gouge, Cobb-Type	J11	Hoehn Grasping Forceps	P4, Q9
Finger Goniometer	W2	Gouge, Endoscopic	J12	Hohmann Retractor	I28-I31b
Finger Retractor	I3-I4	Gouge, Hibbs	J9	Hoke Chisel	J4
Finger Retractor, Vickers	I33	Gouge, Shoulder	J10	Hoke Osteotome	J3
Finger Ring Cutter	Z2	Gouge, Smith Peterson	J7	Hoke Rack	AA2
Fixator	L20	Gouge, Spinal	J11	Holsher Nerve Retractor	I7
Fixed Ratchet Mechanism	I56	Gouge, Stille-Type	J8	Holzheimer Retractor	I34
Flat Nose K-Wire Pliers	S22	Gouge, Swan Neck	J10	Hook Knife	Q1
Flat Nose Pliers	S21-S22	Gouges	Section J	Hooks, Bone	G19-G20
Flash Trays	Y7	Gradle Scissors	A9	Hooks, Sharp	U15
Flexible Rake Retractor	I3	Graefe Eye Forceps	A26	Horizontal Retractor	I48
		Graft Driver	K8-K9	Hudson Burrs	S9

Hudson Drill	S9		K-Wire Side Cutter	S12-S14
Humeral Head Retractor	I22-I25			
Humeral Retractors	I19			
		- I -	- L -	
Infero-posterior Acetabular Cap Retractors	I18		La Borde Dilator	I51
ID Sheet Tape	Y10		Lahey Retractors	I3
Impactor, Bone	K8		Lahey Vulsellum Forceps	A20
Implants	Section R		Lambert-Lowman Clamp	L11
Inge Retractor	I43		Lambotte Forceps	L16
Ingrown Nail Forceps	D5		Lambotte Osteotome	J2-J3
Ingrown Nail Instrument	D9		Lambotte Rack	AA1
Ingrown Nail Splitting Scissors	D6		Lamina Spreader	I43-I44
Initial Incision Retractor	I42		Laminectomy Punches	O14-O17
Inlet Closure Non-Disposable	P3		Laminectomy Retractor	I42
Insert Drill Sleeves	U7		Laminectomy Rongeur	N10
Intramedullary Pin Chuck	S3		Laminectomy Set	BB2
Instrument Care	Sections AA & Y		Lane Bone Forceps	L12-L13
Instrument Cleaning Brush	Y4		Lane Periosteal Elevator	G4
Instrument Containers and Racks			Langenbeck Elevator	G4
	Sections AA & Y		Langenbeck Forceps	L8
Instrument Flat Pack	AA1		Langenbeck Metacarpal Saw	M5
Instrument Identification Roll	Y10		Langenback Periosteal Elev	G4
Instrument Protectors	Y11		Langenbeck Retractor	I8
Instrument Sets Section	BB		Large Bone Set	BB13
Instrument Stringers	Y9		Large Bone Wire Set	BB9
Instrument Trays w/Covers	Y6		Large Cleaning Brushes	Y4
Interchange. Osteo. Set	J1		Large Countersink	U3
Interchangeable Chisel Set	J1		Large Fragment Set	BB18
Interchangeable Gouge Set	J1		Large Locking Pliers	S25
Internal Fixation Set	BB5		Large Needle Nose Locking Pliers	S26
Intervertebral Disc Rong	O4		Large Pin Cutter	S17
Intestinal Forceps	A20-A21		Large Round Blades	I42
Iodine Cups	Y8		L-Buttress Plates	T18
Iris Forceps	A27		Lead Hands	Z1
Iris Scissors	A8		Lead Mallets	K1
Iris Scissors, Ribbon Type	A8		Leksell Rongeur	N8
Iris Scissors, Super-Cut	A2		Lempert Rongeur	N3
Iris TC Scissors	A12		Lewin Bone Forceps	L2
Israel Rake Retractor	I17		Lewin Bone Holding Forceps	L2
Ivd Rongeurs	O4-O11		Lewis Rasp	F4
		- J -	Lexer Chisel	J6
Jackson Tracheal Hook	I5		Lexer Mini Chisel	J6
Jacobs Universal Chuck	U14		Lid Retractor	I3
Jamison Scissors, Super-Cut	A2		Ligature Needles	A38
Jansen Curette	H1		Lightweight Mallet	K2
Jansen Retractor	I34		Linde-Ragnell Retractor	I4
Jansen-Zaufal Rongeur	N5		Lineman Pliers	S23
Jet Wire Twister	S31		Lister Bandage Scissors	A12
Jewelers Forceps	A28, A38		Lister Bandage Scissors, Super Cut	A3, E1
Jig Pin	R9		Lister Bandage w/Lg Handle	A3, E1
Johns Hopkins Bulldog Clamps	A16		Liston Amputation Knife	M7
Johnson Neuroma Retractor	I41		Liston Bone Forceps	M2
Johnson-Tucker Hook And Fork	D7		Littauer Bone Forceps	M1
Joint and Calaneal Spreader	D12,135		Littauer Stitch Scissors	A10
Joint Calcaneal	I35		Little Retractor	I6
Joker Elevator	G5		Little Scissors	A9
Jones Towel Forceps	A22		Locke Elevator	D8
Joseph Bone Saw	M5		Locke Phalangeal Forceps	L1
Joseph Hook	I2		Locking Pliers	S25-S28
Joseph Rasp	F4		Locking Pliers w/Slaphammers	S27-S28
		- K -	Long Bevel Osteotome	J2
Kelly Blades	I57		Long Bone Curette	H9
Kelly Fistula Scissors	A7		Long Bone Hook	G21
Kelly Forceps	A16			
Kelly Retractor	I11			
Kern Bone Forceps	L12			
Kerrison Punch, Endo	O18			
Kerrison Punches	O12-O18			
Keys, Hex	U17			
Key Periosteal Elevator	G5			
Keyes Punch	D11			
Keyless Chuck	S2			
Kirk Mallet	K3			
Kirmission Raspatory	G5			
Kirschner Bow	S34			
Kirschner Drill	S8			
Kirschner Wire	R1			
Kirschner Wire Benders	S2-S4			
Kleinert Kutz Elevator	G2			
Kleinert Kutz Rasp	F6			
Kleinert-Kutz Forceps	M5			
Kleinert-Kutz Hook	I2			
Kleinert-Kutz Retriever	P3			
Kleinert-Kutz Synovectomy Rongeur	N4			
Kleinert-Kutz Tendon Retriever	P3			
Knee Retractors	I25-I26			
Knee Set	BB14			
Knife, Banana	Q1			
Knife, Bayonet	Q1			
Knife, Hook	Q1			
Knife, Planning	Q1			
Knife, Rosette	Q1			
Knife, Scalpel	Q1			
Knife, Sickle	Q1			
Knife, Plaster	E3			
Knives, Bone	M7			
Knowles Bandage Scissors	A13			
Kocher Forceps	A17			
Kolbel Retractor Blades	I22a			
Kolbel Retractor	I22a-I22b			
Kolbel Ret. Ring Handle 8" Hinge	I22a			
Kolbel Shoulder Retractor	I24			
Kolbel Soft Tissue Retractor	I22b			
Kolbel w/Center Blade	I22b			
Krayenbuehl Nerve Hook	I7			
Kuntscher Diamond Awl	G18			
K-Wires	R1			
K-Wire and Pin Benders	S2-S4			
K-Wire and Pin SCASE	AA3-AA4			
K-Wire and Plate Bender	S4			
K-Wire and Steinmann Pins	R1-R2			
K-Wire Cutter	S10			
K-Wire Dispenser	S1			
K-Wire Driver	S2-S3			
K-Wire End Cutter	S11			
K-Wire Extraction Pliers	S22			
K-Wire Guide	L6			
K-Wire Pliers	S20-S28			
K-Wire Racks	R5-R6, AA3-AA4			
K-Wire Ruler and Pin Gauge	W3			

Long Bone Hook Blunt	G21	Mayo Hegar Needle Holder	A31	Mini-Lambotte Osteotome	J2
Long Elevator w/Silicone Handle	G12b	Mayo-Noble Scissors	A6	Minimally Invasive Disc Set	BB1
Long Cobb Elevator	G12a	Mayo Scissors	A5	Minor Orthopedic Set	BB13
Long Cobb Curette	H10	Mayo Scissors, Super-Cut	A1	MIS Instruments	Section X
Long Jaw Needle Nose Pliers	S23	Mayo TC Scissors	A11	Miskimon Retractor	I40
Loose Body Grasper	Q9	Mayo-Stille Scissors	A6	Mixing Bowls	Y8
Lorna Towel Clamp	A23	McBride Spinal Retractor	I52a	Mixer Forceps	A17
Loutie Wire Tightener	S30	McCulloch Retractor	I61	Modified Fukuda	I20
Love Nerve Retractor	I6	McCulloch Retractor Blades	I62	Moleskin Scissors	D6
Love-Gruenwald Ivd Rong	O4	McElroy Curette	H10	Moore Drill	S7
Love-Kerrison Punch	O14, O17	Mcindoe Bone Cut Forceps	M2	Mosquito Forceps	A15-A16
Low Profile Small Retractor	I33	Mckenty Elevator	G1	Mosquito Forceps, Micro	A15
Lowe-Breck Cartilage Knife	P5	Mckenzie Drill Bit	S9	Mother In-Law Retractor	I31a
Lowman Bone Clamp	L11	Mead Mallet	K2	Mueller Capsule Scissors	P1
L-Plates	T11-T12	Mead Rongeur	N6	Mueller Typer Femoral Neck Retractor w/Knurled Handle	I17
Lucae Bone Mallet	K1	Measuring Devices	Section W	Multi-Bite Kerrison Punch	O16
Luer Rongeur	N6	Measuring Tape	W3	Multi Trac Retractor Set	I55-I58
Lumbar Micro Curette	H11	Medicine Cups-Graduated	Y8	Multiple Fragment Plate	T12
Lumbar Driver & Impactor	K9	Medium Locking Pliers	S25	Murphy Bone Skid	I9
Lumbar Lamina Spreader	I44	Medium Pin Cutter	S16	Mycotic Nail Nipper	D3
— M —					
Magill Endotracheal Forceps	A22	Meniscotome, Smillie	Q1	— N —	
Major Orthopedic Set	BB12	Meniscal Clamp 7"	P3	Nail Instruments	Section D
Malleable Retractor	I9	Meniscus Clamp	P2	Nail Nippers	D3-D5
Malleable Retr. w/Protective Edge	I57	Meniscus Knife	P5	Nail Rasp	D7
Malleolar Bone Screws	T6	Meniscus Probe	Q1	Nail Removing Forceps	D5
Malleolar Countersink	U3	Metacarpal Saw	M5	Nail Scissors	A9, D6
Malleolar Forceps	L3	Metatarsal Elevator	G8	Nail Spicula Forceps	D6
Mallet #49	K1	Metatarsal Retractor & Spreader	I35	Nail Splitters	D1, D8
Mallet, Bergman	K4	Metzenbaum Scissors	A7	Nail Splitting Forceps	D1-D2
Mallet, Cloward - Style	K3	Metzenbaum Scissors, Super-Cut	A1	Nail Splitting Scissors	D6
Mallet, Collin	K2	Metzenbaum TC Scissors	A11	Narrow Nose Pliers	S23
Mallet, Combination	K3	Meyerding Blades	I50	Narrow Nose Wire Pulling Forceps	S23
Mallet, Dead Blow	K5	Meyerding Finger Retractor	I5	Narrow Plates	T19
Mallet, Gerzog	K1	Meyerding Lam. Retractor	I16, I41	Narrow Tip Mallet	K2
Mallet, Heath	K4	Michel Clip Forceps	A37	Needle Holders	A29-A32
Mallet, Heavyweight	K4-K5	Michele Trephine	M8, U20	Needle Nose Locking Pliers	S26
Mallet, Kirk	K3	Micro Curettes	H12	Needle Nose Locking Pliers w/Slaphammer	S28
Mallet, Lightweight	K2	Micro Forceps	A24	Needle Nose Pliers	S20-S23
Mallet, Lucae	K1	Micro Fracture Chondro Picks	Q10	Nerve Probes	G2
Mallet, Mead	K2	Micro Friedmann Rongeur	N1	Nerve Probe Endoscopic	G2
Mallet, Mini	K1	Micro Mosquito Forceps	A15	Nerve Retractors	I6-I7, I31c
Mallet, Narrow Tip	K2	Micro Surgery Sets	BB11	Neuro-Caliper	W2
Mallet, Orthopedic	K3-K5	Micro Tray	Y1	Neurological Hammer	A36
Mallet, Phenolic Handle	K5-K6	Mini Bone Wire Set	BB7	Neuro Pin Wheel	Z2
Mallet, Reproccussion Free	K5	Mini Chisel	J6	Johnson Neuroma Retractor	I43
Mallet, Wagner	K6	Mini Compression Plate	T13	Nievert Needle Holders	A30
Mallets	Section K	Mini Countersink	U3	Northbent Stitch Scissors	A10
Maltz Rasp	F5	Mini Cruciform Screwdriver Bit	U10	Nucleus Knife	D8
Maltz-Seeburger Retractor	I49	Mini Fixation Set	BB4	Nut	T8
Markham-Meyerding Retr	I41	Mini Fragment Fixation Set	BB5	— O —	
Martin (Parham) Bone Clamp	L13	Mini Friedmann Rongeur	N2	O'Brien Bone Clamp	L2
Martin Cartilage Clamp	P1	Mini Hohmann Retractor	I28	Oblong Instrument Trays	Y7
Martin Cartilage Scissors	P1	Mini L Plates	T11	Ochsner Forceps	A17
Martin Drill	S7	Mini Mallet	K1	Offset Nerve Retractor	I6-I7
Martini Bone Curette	H1	Mini Plate Bending Iron	U21	Ohl Elevator	G1
Master Guide -Trauma Instr.	T1-T2	Mini Plate Bending Pliers	U22	Oldberg Ivd Rongeur	O9
Masterguide Screw, Bits, Taps	T1-T2	Mini Plates	T11	Olive Tip Plunger Brush	Y4
Mathieu Needle Holder	A32	Mini Scalpel Handle	A34	Oiler Rake Retractor	I15
Mathieu Retractor	I4	Mini Screwdriver	U10	Olsen-Hegar Needle Holders	A31
Mayo-Collins Retractor	I14	Mini T Plates	T11		

One-Handed Rod Bender	U24	Piffard Curettes	D11	Probe, Meniscus	Q1
One Third Tubular Plates	T16	Pin And K-Wire Sterilization Case		Probes	A36
Open End Wrenches	U17		R4-R5, AA3-AA4	Providence Hospital Forceps	A16
Operating Scissors	A4	Pin and Wire Cutters	S10-S17	Punch Bite Styles	O1
Operating Scissors, Super-Cut	A3	Pin Bender	S3	Punches, Arthroscopic	Q2-Q8
Operating TC Scissors	A11	Pin Chuck	S3	Punches, Spinal	Section O
Ortho Rongeur w/Pistol Grip	N11	Pin Cutter Large	S17	Putti Bone Rasp	F6
Orthomed Cast Spreader	E4	Pin Cutter Medium	S16		
Orthomed Comedone Extractor	D10	Pin Cutter Small	S16	— Q —	
Orthomed Forceps Holder	Z2	Pin Drivers	S2-S3	Quarter Tubular Plate	T13
Orthomed Skin Hook	I1	Pin Gauge	W3	Quick Coupling Drill Bits	U3
Orthomed Utility Scissors	A14	Pin Inserter/Extractor With T-Handle	S3	Quick Coupling Handle	U5
Orthomed Utility Shears	A14, E2	Pin Puller	S25	Quick Coupling Screwdriver	U5
Orthomed K-Wire Sterilization Container R7, AA5		Pin Pulling Forceps	I21	Quick Coupling Taps	U4
Orthomed K-Wire and Steinmann Pin		Pin Pulling Pliers	S21	— R —	
Sterilization Case R4-R5,R8,AA3-AA4,AA6		Pin Wheel	Z2	Racks, Sterilization and Storage	
Orthopedic Mallets	K3-K5	Pins	R2-R3	Section Y, Section AA	
Orthopedic Sets List	BB12-BB13	Pituitary Curettes	H2	Ragnell Retractor	I4
Osteotome Blades	J1	Plain Splinter Forceps	A28	Ragnell Scissors	A7
Osteotome, Cobb	J10	Planning Knife	Q1	Rake Retractors	I3, I19
Osteotome, Endoscopic	J12	Plaster Breaker Wolff	E4	Ralks Drill	S5
Osteotome, Hibbs	J8,J12	Plaster Cast Breaker	E4	Randall Suction Biopsy Curette	B5
Osteotome, Hoke	J3	Plaster Cast Instruments	Section E	Rankin-Kelly Forceps	A16
Osteotome, Lambotte	J2-J3	Plaster Knife	E3	Rasp Salehi lumbar Foraminal	F7
Osteotome, Long Bevel	J2	Plaster Saw	E3	Rasps, Bone	Section F
Osteotome, Sheehan	J4	Plaster Spreader	E5	Rasp Set w/Inserts	F7
Osteotome, Smith Peterson	J7	Plastic Surgery Scissors	A4	Rat Tooth Rongeur	N7
Osteotome, Stille-Type	J8	Plate and Bone Holding Forceps	L1-L2	Ray Pituitary Curettes	H2
Osteotomes	Section J	Plate Benders	U21	Rectal Instruments	B8-B10
Osteotomy Guide	D5	Plate Bending Instruments	U21-U23	Reill Bone Reduction Forceps	L5
— P —		Plate Bending Press	U23	Reiner Plaster Knife	E3
Packer, Bone Chip	K7	Plate Bending Templates	S4	Repofix® Plus	L21
Retractor	X3	Plate Cutter	S20	Repofix® Spider	L21
Peapod Ivd Rongeur	O7	Plate Cutting Forceps	U23	Reposition Forceps	L6a
Parallel Pliers	S24	Plate Holding Clip	U15	Reprocssion Free Mallet	K5
Parallel Pliers w/Cutter	S24	Plate Holding Forceps	U20	Resected Patella Protector	X3
Parham-Martin Bone Clamp	L13	Plate, Cloverleaf	T14	Retractors	Section I
Parker Retractors	I14	Plate, Compression	T13-T14	Retractors, Laminectomy	I16, I40-I51
Parker-Mott Retractor	I14	Plate, Multiple Fragment	T12	Retractors, Spinal	I17-I23
Patella Forceps	L3	Plate, Tubular	T16	Reverse Lock Chuck	S2-S3
PCL Retractor	X4	Plates, Mini	T11	Reynolds Scissors	A5
Pediatric Cast Breaker	E3	Platypus Nail Removing Forceps	D5	Rhoton Micro Instruments	G15
Periosteal Elevators	G3-G9	Pliers	S20-S28	Rib Elevator	G14
Pediatric Wire Cutter	S10	Pliers For Cerclage Wire	S20-S21	Ribbon Retractor	I9
Peers Towel Clamp	A23	Pliers With Double Action	S24	Richardson Retractor	I15
Pelvic Instrument Set	BB17	Pliers, Locking	S25-S27	Richardson-Eastmann Retractor	I15
Pelvic Reduction Forceps	L8-L10	Pliers, Locking w/Slaphammers	S28	Right Angled Hohmann Ret.	I31b, X4
Pelvic Retractor	I26	Pliers, Plate Bending	U22	Rigid Rake Retractor	I3
Penfield Elevators	G16	Plug Cutters	M8	Ring Curette	H5, Q1
Penfield Elevator Endoscopic	G3	Pointed Drill Guide	U8	Ring Cutter	Z2
Pennington Forceps	A19	Polk Finger Goniometer	W2	Rinsing Cannula w/Stopcock	Q10
Percussion Hammer	A36	Polokoff Rasp	F2	Rochester Pean Forceps	A17
Percy Amputation Shield	M6	Poole Suction Tubes	A34	Rochester-Carmalt Forceps	A18
Periarticular Reduction Clamp	L19-L20	Posterior Collateral Retractor	X1	Rochester-Ochsner Forceps	A17
Periarticular Reduction Forceps	L19	Posterior Glenoid Neck Retractor	I22	Rod Benders	U24-U25
Periosteal Elevators	G6-G8	Power Drill Adaptor	U3	Rod Cutter	S14b
Perthes Bone Awl	G17	Presbyterian Tube Forceps	A21	Rod Holder for Rods	S26
Phalangeal Forceps	L1	Press, Bending	U23	Roger Wire Cutting Scissors	S11
Phenolic Handle Mallet	K5	Preston Meniscus Forceps	P2	Rollet Retractor	I2
Phenolic Handle Screw	U12-U13	Probe and Excavator	D7	Rongeur #4	N3
		Probe and Packer	D7	Rongeur #4A	N3
				Rongeur, Adson	N7

Rongeur Bite Styles	O1	Screw Holding Forceps	U15	Small Hexagonal Screwdriver	U10
Rongeur, Chichirelli	N2	Screw Removal Forceps	S23	Small Locking Pliers	S25
Rongeur, Dean	N2	Screw Fixation Set	BB18	Small Pin Cutter	S16
Rongeur, Echlin	N7	Screw Set	BB16, BB18	Small Plate Bending Irons	U21
Rongeur, Friedman	N1	Screwdriver for Distraction Screws	I52d	Small Plate Bending Pliers	U22
Rongeur Indent Chart	O1	Screwdriver Handles	U14	Small Quick Coupling T-Handle	U5
Rongeur, Leksell	N8	Screwdriver Set	U14	Small Screw Fixation Set	BB18
Rongeur, Lempert	N3	Screwdriver Sleeve	U11	Small Wound Retractor	I33
Rongeur, Micro Friedman	N1	Screwdrivers	U10-U14	Smillie Knee Retractors	I27
Rongeur, Rat Tooth	N7	Screws, Cancellous	T5-T8	Smillie Knife	P5
Rongeur, Ruskin	N4-N5	Screws, Cortical Bone	T3-T6	Smillie Menisctome	Q1
Rongeur, Stille-Luer	N7	Screws, Malleolar	T6	Smith Peterson Gouge	J7
Rongeur, Synovectomy	N1	Screws, Self-Tapping	T8-T10	Smith Peterson Osteotome	J7
Rongeur, Syptert	N10	Sedillot Elevator	G4	Smith Peterson Rack	AA1
Rongeurs	Section N	Seletz Retractor	I36	Smith-Peterson Rongeur	N10
Rongeurs, Spinal	Section O	Self-Retaining Retractors	I34	Smithwick Hook	G2, I5
Rosenbloom Clamp	L1	Self-Retaining Screw Holding Fcps.	U15	Snitman Retractor	I37
Rosette, Knife	Q1	Selverstone lvd Rongeur	O9	Socket Wrench	U16
Roux Retractors	I14	Semb Bone Holding Forceps	L7	Soft Corn Knife	D9
Ruler and Pin Gauge	W3	Semi-Tubular Plates	T16	Soft Corn Spoon Knife	D9
Rulers	W3	Semken Forceps	A24	Solution Bowls	Y8
Rush Awl and Reamer	G17	Senn Retractor	I4	Spatula And Packer	D7
Ruskin Rongeur	N4-N5	Sesamoid Clamp	L2	Speciality Cleaning Brushes	Y5
Ruskin-Liston Forceps	M2-M3	Sesamoidectomy Clamp	L1	Speciality Retractors	I57
Russian Tissue Forceps	A26	Set, Bone Wire	BB7-BB10	Spencer Stitch Scissors	A10
Ryder Micro Needle Holder	A32	Sharp Hook	U15	Spiked Disc	U16
Ryder Needle Holder	A32	Shears	E2-E3	Spine Retractor	I52a
- S -					
Saalfeld Comedone Extractor	D10	Shears, Bruns	E2	Spinal Curette	H4-H5, H7-H8
Sachs Nerve Elevator	G2	Shears, Esmarch	E3	Spinal Elevators	G11-G13
Safety Senn Retractor	I4	Shears, Plaster	E2-E3	Spinal Gouge	J11
Sarot Needle Holders	A32	Sheehan Osteotome	J4	Spinal Handle Styles	O2-O3
Satterlee Bone Saw	M6	Short Jaw Nail Splitter	D2	Spinal Identification Charts	O1-O3
Saw Blades, Gigli	M7	Short Round Blades	I42	Spinal Punches	Section O
Saw, Plaster	E3	Shortbent Stitch Scissors	A10	Spinal Retractor	I16, I40-I51
Saws, Bone	M5-M6	Shoulder Awls	G17-G18	Spinal Rongeurs	Section O
Saxena Bone Grafting Retractor	I39	Shoulder Penetrating Gouge	J10	Spinal Rongeurs Handles	O2-O3
Sayre Elevator	G3	Shoulder Retractors	I19-I26	Splinter Forceps	A28
Scale, X-Ray	W3	Shoulder Set	BB15	Sponge Forceps	A23
Scalp Contour Retractor	I37	Side Bite Wire Cutter	S12	Spoon	Q1
Scalpel Handles	A34-A35	Side Cutter	S12-S14	Spoon Plates	T17
Scalpel Knife	Q1	Side Pin Cutter	S15	Spratt Curette	H3-H4
Schamberg Comedone Extractor	D10	Single and DoubleScope Trays	Y2	Spreader, Plaster Cast	E4-E5
Schanz Pins	R3	Silicone T Handle	S25	Spring Wire Retractor	I32
Schink Retractor	I49	Silicon Wire Cutter	S13	Spurling lvd Rongeur	O4
Schlesinger lvd Rongeur	O10	Silver Osteotome	J4	Spurling Kerrison Punch	O13, O17
Schlesinger Punch	O15	Sims Scissors	A5	Stagbeetle Bone Forceps	L3
Schmidt Forceps	A19	Single Slot Screwdriver	U11	Star Drive Screwdriver Shaft	U11
Scissors	A1-A15	Single Prong Acetabular Retractor	I31d	Star Driver	U12
Scissors, Arthroscopic	Q2-Q8	Single Prong Retractor	I17	Steinmann Pin Chuck	S2
Scissors, Super-Cut	A1-A3	Sistrunk Scissors	A6	Steinmann Pin Dispenser	S1
Scissors, TC	A11-A12	Skid Lever	I9	Steinmann Pins	R2-R3
Scissors, Wire Cutting	A15	Skin Hooks	I1-I2	Stepped Point Bone Holding	L4
Scoliosis Retractor	I52	Skin Scissors	A8	Sterilization Case, Drill Bit	U2
Scoville Blades	I50	Slaphammers, w/Locking	S27-S28	Sterilization Case, K-Wire And Pin	R5-R6, AA3-AA4
Scoville Curette	H3	Sleeve, Tap	U7-U8	Sterilization Racks	Section Y, Section AA
Scoville Curette, Endo	H8	Slip Joint Pliers	S24	Sterilization Tray	Y2
Scoville Nerve Retr	I6	Small Bone Set	BB14	Sterilizing Container	Y3
Scoville Retractor Set	I50-I51	Small Bone Wire Set	BB8	Stevens Scissors, Super-Cut	A2
Screw Depth Gauge	W1	Small Countersink	U3	Stevens Tenotomy Scissors	A8
Screw Extraction Set	U26	Small Fixation Set	BB4	Stille Pattern Drill	S6
		Small Fragment Set	BB6		

Stille Plaster Shears	E5	Tension Device	U15-U16	Vertebra Spreader	I44
Stille Plaster Spreader	E5	T-Handle	U5	Verucca Curette Excavator	D8
Stille-Horsley Forceps	M4	T-Handle Pin Chuck	S2	Vickers Easidriver™	S2
Stille-Liston Forceps	M4	T-Handle, Pin Inserter/Extractor	S3	Vickers K-Wire Dispenser™	S1
Stille-Luer Echlin Rongeur	N7	T-Handle, Quick Coupling	U5	Vickers Retractors	I31
Stille-Luer Rongeur	N9	T-Handle Torque Limiter	S25	Virtus Splinter Forceps	A29
Stille-Sherman Drill	S6	T-Handle Universal Chuck	S2	Vogen Sesamoid Clamp	L2
Stille-Type Chisel	J8	Thin Foot Plate Punches	O12	Volkman Bone Hooks	G19
Stille-Type Gouge	J8	Thoracic Rongeur	N10	Volkman Finger Retractor	I3
Stille-Type Osteotome	J8	Threaded K-Wire	R1	Volkman Retractor	I3, I8
Stitch Scissors	A10	Threaded Pins	R2	Volkman Curettes	H1, H9
Stockinette Scissors	A3, E1	Three-Fluted Drill Bits	U1	Vorse Tube Forceps	A21
Storage Containers	Section Y	Thumb Forceps	A24-A25	— W —	
Storage Racks	Section Y, Section AA	Tibial Retractor	X1, X3, X4	Wachenfeldt Clip Forceps	A37
Strabismus Scissors	A8	Tilt Ratchet Mechanism	I56	Wagner Mallet	K6
Strabismus TC Scissors	A12	Tissue Forceps	A23, A25	Walton Cartilage Clamp	P2
Straight Ball Spike	U16	Tissue Nippers	D2	Walton Cast Spreader	E4
Stringer, Instrument	Y9	Tissue Retractor	I37	Wartenberg Neuro Pin Wheel	Z2
Styles	I53-I54	Torque Limiter	S24a	Washer	T8
Subacromium Retractor	I21	Total Hip Retractor	I50	Wauch Retractor	I32
Suction Tubes	A33-A34	Towel And Sponge Forceps	A22-A23	Weber Elevator	G12 b
SUNY Upstate Curette	H5	Townley Caliper	W1	Webster Needle Holder	A30
Super-Cut Bandage Scissors	A3	T-Plates	T12, T15, T17	Weitlaner Retractor	I37
Super-Cut Scissors	A1-A3, E1	T-Plates Oblique	T15	Wiener Skin Hooks	I1
Suture Instruments	A37-A38	Tray (Empty)	U26	Weinstein Sterilizing Rack	Y9
Suture Guide	P3	Trays	Y6-Y7	Wilde IVD Rongeur	O8
Suture Passer	G17	Trephine	M8	Williams Hemi Lam. Retractor	I41
Suture Passer w/ Crochet hook	G17	Tri Handle Items	Q1	Williams IVD Rongeur	P6
Suture Passer w/ Suture Hole	G17	Triple Wire And Drill Guide	U7	Williams Rongeur	R8
Suture Scissors	A9-A10	Trosseau Dilator	I51	Williams Screwdriver	U13
Swan Neck Gouge	J10	Tubes	A33-A34	Williams Splinter Forceps	A29
Swing Apart Kerrison Rongeur TFP	O19	Tubing And Utility Forceps	A21	Williger Bone Curettes	H1
Swiss Jewelers Forceps	A28	Tubular Plates	T16	Wiltse-Gelpi Retractor	I36
Swivel Head Forceps	L16	Tungsten Carbide Scissors	A11-A12	Window Bone Forceps	L5
Synovectomy Rongeurs	N1	Twist Drill for Distraction Screw	I52d	Wire And Pin Benders	S2-S4
Sypert Rongeur	N10	Tyrell Hook	I1	Wire And Pin Cutters	S10-S17
— T —		— U —		Wire And Pin Drivers	S2-S3
Table Fixation And Ring Case	I58	U.S. Army Chisel	J5	Wire And Pin Implants	Section R
Table Mounting Components	I56	U.S. Army Gouge	J5	Wire And Pin Instruments	Section S
Table Top Rod Cutter	S18	U.S. Army Osteotome	J4	Wire And Pin Tractor	S34
Takahashi Ivd Rongeur	O7	U.S. Army Retractor	I9	Wire Bender	S3
Tamps	K7-K8	Ulrich Self-Retaining Forceps	L18	Wire Cutter, Delicate	S10
Tap Sleeve	U7-U8	Universal Chuck With T-Handle	S2	Wire Cutter, Double Action	S13
Tape, Measuring	W3	Universal Drill	S5	Wire Cutter, End	S11
Taps	R9	Universal Drill Guide	U7	Wire Cutter, Side	S12, S14
Taylor Laminectomy Blades	I51	Universal Jacobs Chuck	U14	Wire Cutter w/Safety	S13
Taylor Percussion Hammer	A36	Universal Rod Bender	U25	Wire Cutter w/Silicon	S13
Taylor Retractor Long Blade	I31 d	Universal Retractor, Vickers	I33	Wire Cutters	S10-S17
Taylor Spinal Blades	I51	Universal Scope and Light Cable Tray	Y2	Wire Cutting Scissors	A15, S11
Taylor Spinal Retractor	I31d	Universal Sterilization Trays	Y2	Wire Extraction Pliers	S22
T-Buttress Plates	T18	Unna Comedone Extractor	D10	Wire Fixation Sets	BB7-BB10
Tebbetts Style	I53	Utility Clip Mini	A37	Wire Guide	S32
Telescopic Hand Drill	S8	Utility Clip Large	A37	Wire Passer	S32
Templates, Bending	U18-U19	Utility Forceps	A21	Wire Pulling Forceps	S29
Tendon Instruments	Section P	Utility Scissors	A14, E2	Wire Storage, Sterilization	R5-R6, AA4-AA5
Tendon Pulling Forceps	P2-P3	Utility Shears	E2	Wire Tightener	S29-S30
Tendon Retriever	P3	— V —		Wire Twisters	S29-S31
Tendon Stripper	P5	Van Buren Forceps	L7	Wire Twisting Forceps	S29-S31
Tendon Weaving Forceps	P4	Vanguard Splinter Liberator	A29	Wires And Implants	Section R
Tenotomy Scissors	A8	Vein Retractor	I8	Wolff Plaster Breaker	E4
Tenotomy Scissors, Super-Cut	A2	Verbrugge Bone Forceps	L14-L15		

Woodson Dural Sep/Packer G14
Woodson Elev/Spatula G14
Wrenches U16-U17

— X, Y, Z —

X-Ray Scale W3
XL Cervical Micro Curette H11
Yankauer Suction Tube A34
Zaufal-Jansen Rongeur N5
"Z" Retractors X2-X3

NUMERICAL INDEX



OM 14-0455A	S25	OM 33-0312	A4	OM 34-0486	A7	OM 35-0626	A11
OM 15-0355	S25	OM 33-0314	A4	OM 34-0488	A7	OM 35-0628	A11
OM 12500	K6	OM 33-0320	A4	OM 34-0492	A7	OM 35-0630	A11
OM 2008	Y13	OM 33-0322	A4	OM 34-0494	A7	OM 35-0640	A11
OM 1700040	P3	OM 33-0324	A4	OM 34-0502	A7	OM 35-0642	A11
OM 6060	P3	OM 33-0370	A4	OM 34-0504	A7	OM 35-0644	A11
OM 6070	P3	OM 33-0372	A4	OM 34-0560	A7	OM 35-0646	A11
OM 28-0460	A36	OM 33-0374	A4	OM 34-0562	A7	OM 35-0652	A11
OM 28-0468	A36	OM 33-0470	A4	OM 34-0602	A7	OM 35-0654	A11
OM 28-0492	A36	OM 33-0472	A4	OM 34-0607	A7	OM 35-0670	A12
OM 28-0514	Z2	OM 33-0474	A4	OM 34-0612	A7	OM 35-0672	A12
OM 29-0058	A35	OM 33-0482	A4	OM 35-0068	A10	OM 35-0674	A12
OM 29-0059	A35	OM 33-0484	A4	OM 35-0078	A9	OM 35-0676	A12
OM 29-0060	A35	OM 33-0486	A4	OM 35-0080	A10	OM 36-0063	A15
OM 29-0061	A35	OM 33-0490	A4	OM 35-0084	A10	OM 36-0067	A15
OM 29-0062	A35	OM 33-0492	A4	OM 35-0092	A10	OM 36-0076	A16
OM 29-0064	A35	OM 33-0494	A4	OM 35-0104	A10	OM 36-0078	A16
OM 29-0070	A34	OM 33-0520	A4	OM 35-0120	A10	OM 36-0106	A16
OM 29-0071	A34	OM 33-0522	A4	OM 35-0168	A15	OM 36-0108	A16
OM 29-0073	A34	OM 33-0524	A4	OM 35-0170	A15	OM 36-0156	A16
OM 29-0430	Z2	OM 33-0532	A4	OM 35-0192	A15	OM 36-0158	A16
OM 29-0434	Z2	OM 33-0534	A4	OM 35-0194	A15	OM 36-0160	A16
OM 29-0495	D11,H6	OM 33-0536	A4	OM 35-0198	A15, S11	OM 36-0162	A16
OM 29-0496	D11,H6	OM 33-0538	A4	OM 35-0200	A15, S11	OM 36-0164	A15
OM 29-0497	D11, H6	OM 33-0540	A4	OM 35-0202	A3	OM 36-0165	A15
OM 29-0498	D11, H6	OM 33-0542	A4	OM 35-0210	A3, E1	OM 36-0166	A16
OM 29-0499	D11, H6	OM 33-0544	A4	OM 35-0212	A3, E1	OM 36-0168	A16
OM 29-0500	D11, H6	OM 34-0140	A4	OM 35-0214	A3, E1	OM 36-0176	A17
OM 29-0503	D11,H6	OM 34-0142	A4	OM 35-0220	A3	OM 36-0178	A17
OM 29-0505	D11,H6	OM 34-0150	A4	OM 35-0250	A3	OM 36-0180	A17
OM 29-0507	D11,H6	OM 34-0152	A4	OM 35-0280	A1	OM 36-0182	A17
OM 29-0511	D11	OM 34-0256	A5	OM 35-0286	A1	OM 36-0186	A17
OM 29-0512	D11	OM 34-0258	A5	OM 35-0292	A1	OM 36-0188	A17
OM 29-0513	D11	OM 34-0260	A5	OM 35-0298	A1	OM 36-0196	A16
OM 29-0514	D11	OM 34-0262	A5	OM 35-0316	A1	OM 36-0198	A16
OM 29-0515	D11	OM 34-0280	A5	OM 35-0322	A1	OM 36-0306	A17
OM 29-0517	D11	OM 34-0282	A5	OM 35-0340	A1	OM 36-0308	A17
OM 29-0566	D10	OM 34-0292	A5	OM 35-0364	A1	OM 36-0316	A17
OM 29-0580	D10	OM 34-0294	A5	OM 35-0370	A1	OM 36-0318	A17
OM 29-0582	D10	OM 34-0306	A6	OM 35-0380	A1	OM 36-0326	A17
OM 29-0584	D10	OM 34-0308	A6	OM 35-0382	A1	OM 36-0328	A17
OM 29-0592	D10	OM 34-0310	A6	OM 35-0392	A1	OM 36-0336	A17
OM 29-0604	D10	OM 34-0312	A6	OM 35-0394	A1	OM 36-0338	A17
OM 29-0606	D10	OM 34-0325	A6	OM 35-0396	A1	OM 36-0346	A17
OM 29-0620	H1	OM 34-0327	A6	OM 35-0406	A1	OM 36-0348	A17
OM 29-0630	H1	OM 34-0334	A5	OM 35-0418	A1	OM 36-0356	A17
OM 29-0632	H1	OM 34-0336	A5	OM 35-0430	A1	OM 36-0358	A17
OM 31-0668	A12	OM 34-0338	A6	OM 35-0450	A2	OM 36-0360	A17
OM 31-0680	A12	OM 34-0348	A6	OM 35-0452	A2	OM 36-0362	A17
OM 31-0692	A12	OM 34-0354	A6	OM 35-0454	A2	OM 36-0406	A17
OM 31-0704	A12	OM 34-0356	A6	OM 35-0460	A2	OM 36-0408	A17
OM 31-0708	A12	OM 34-0358	A6	OM 35-0484	A2	OM 36-0416	A17
OM 31-0792	A13	OM 34-0436	A7	OM 35-0490	A2	OM 36-0418	A17
OM 31-0804	A13	OM 34-0438	A7	OM 35-0494	A2	OM 36-0426	A17
OM 31-0830	A14, E2	OM 34-0458	A7	OM 35-0496	A2	OM 36-0428	A17
OM 31-0832	A14, E2	OM 34-0462	A7	OM 35-0510	A12	OM 36-0436	A17
OM 31-0834	A14, E2	OM 34-0466	A7	OM 35-0515	A9	OM 36-0438	A17
OM 31-0836	A14, E2	OM 34-0470	A7	OM 35-0600	A11	OM 36-0446	A17
OM 33-0300	A4	OM 34-0472	A7	OM 35-0610	A11	OM 36-0448	A17
OM 33-0302	A4	OM 34-0474	A7	OM 35-0620	A11	OM 36-0456	A17
OM 33-0304	A4	OM 34-0476	A7	OM 35-0622	A11	OM 36-0458	A17
OM 33-0310	A4	OM 34-0478	A7	OM 35-0624	A11	OM 36-0516	A18

OM 36-0518	A18	OM 38-0304	A23	OM 39-0684	Y3	OM 41-0446	A31
OM 36-0536	A18	OM 38-0322	A23	OM 39-0686	Y4	OM 41-0448	A31
OM 36-0538	A18	OM 38-0324	A23	OM 39-0692	W3	OM 41-0452	A31
OM 36-0557	A17	OM 39-0050	A24	OM 39-0694	W3	OM 41-0454	A31
OM 36-0562	A17	OM 39-0052	A24	OM 39-0698	W3	OM 42-0148	A32
OM 36-0564	A17	OM 39-0055	A25	OM 39-0700	W3	OM 42-0150	A32
OM 36-0566	A17	OM 39-0057	A24	OM 39-0710	W3	OM 42-0152	A32
OM 36-0570	A18	OM 39-0058	A24	OM 41-0064	A29	OM 42-0154	A32
OM 36-0696	A20	OM 39-0059	A24	OM 41-0065	A29	OM 42-0186	A32
OM 36-0744	A18	OM 39-0060	A24	OM 41-0066	A29	OM 42-0188	A32
OM 36-0746	A18	OM 39-0062	A24	OM 41-0067	A29	OM 42-0190	A32
OM 36-0766	A19	OM 39-0063	A24	OM 41-0068	A30	OM 42-0192	A32
OM 36-0816	A18	OM 39-0064	A24	OM 41-0070	A30	OM 42-0196	A32
OM 36-0818	A18	OM 39-0066	A24	OM 41-0092	A30	OM 42-0198	A32
OM 36-0826	A18	OM 39-0068	A24	OM 41-0094	A30	OM 42-0248	A37
OM 36-0828	A18	OM 39-0070	A24	OM 41-0104	A30	OM 42-0254	A37
OM 37-0366	A23	OM 39-0072	A24	OM 41-0106	A30	OM 42-0256	A37
OM 37-0368	A23	OM 39-0074	A27	OM 41-0108	A30	OM 42-0258	A37
OM 37-0370	A23	OM 39-0076	A24	OM 41-0130	A30	OM 42-0558	A38
OM 37-0372	A23	OM 39-0080	A24	OM 41-0132	A30	OM 42-0560	A38
OM 37-0386	A23	OM 39-0086	A24	OM 41-0162	A29	OM 42-0562	A38
OM 37-0388	A23	OM 39-0088	A24	OM 41-0164	A29	OM 42-0564	A38
OM 37-0390	A23	OM 39-0092	A25	OM 41-0166	A29	OM 42-0608	A36
OM 37-0392	A23	OM 39-0098	A25	OM 41-0170	A31	OM 42-0610	A36
OM 37-0444	A21	OM 39-0128	A25	OM 41-0171	A31	OM 42-0612	A36
OM 37-0448	A21	OM 39-0132	A25	OM 41-0172	A31	OM 42-0614	A36
OM 37-0450	A21	OM 39-0136	A25	OM 41-0173	A31	OM 42-0616	A36
OM 37-0452	A21	OM 39-0140	A25	OM 41-0174	A31	OM 42-0618	A36
OM 37-0453	A21	OM 39-0192	A26	OM 41-0175	A31	OM 42-0620	A36
OM 37-0454	A21	OM 39-0196	A26	OM 41-0176	A31	OM 42-0646	A36
OM 37-0455	A21	OM 39-0197	A26	OM 41-0178	A31	OM 42-0647	A36
OM 37-0456	A23	OM 39-0198	A26	OM 41-0198	A32	OM 42-0648	A36
OM 37-0458	A22	OM 39-0310	A25	OM 41-0200	A32	OM 42-0649	A36
OM 37-0462	A22	OM 39-0314	A25	OM 41-0240	A32	OM 42-0654	A36
OM 37-0464	A22	OM 39-0318	A25	OM 41-0242	A32	OM 42-0655	A36
OM 37-0466	A23	OM 39-0322	A25	OM 41-0244	A32	OM 42-0656	A36
OM 37-0468	A23	OM 39-0364	A28	OM 41-0246	A32	OM 42-0823	A33
OM 37-0470	A22	OM 39-0366	A28	OM 41-0248	A32	OM 42-0824	A33
OM 37-0478	A22	OM 39-0386	A28	OM 41-0257	A32	OM 42-0825	A33
OM 38-0076	A23	OM 39-0390	A28	OM 41-0264	A32	OM 42-0826	A33
OM 38-0080	A23	OM 39-0410	A28	OM 41-0265	A32	OM 42-0830	A33
OM 38-0082	A26	OM 39-0412	A28	OM 41-0266	A32	OM 42-0832	A33
OM 38-0084	A23	OM 39-0450	A28	OM 41-0267	A32	OM 42-0834	A33
OM 38-0088	A23	OM 39-0451	A28	OM 41-0268	A32	OM 42-0836	A33
OM 38-0094	A23	OM 39-0452	A28	OM 41-0270	A31	OM 42-0844	A34
OM 38-0100	A23	OM 39-0453	A28	OM 41-0272	A31	OM 42-0852	A34
OM 38-0106	A23	OM 39-0455	A28	OM 41-0278	A31	OM 42-0863	A33
OM 38-0166	A27	OM 39-0456	A28	OM 41-0284	A31	OM 42-0864	A33
OM 38-0180	A27	OM 39-0478	A29	OM 41-0286	A31	OM 42-0866	A33
OM 38-0181	A27	OM 39-0509	A29	OM 41-0300	A31	OM 42-0873	A33
OM 38-0182	A27	OM 39-0511	A29	OM 41-0302	A31	OM 42-0874	A33
OM 38-0184	A27	OM 39-0513	A29	OM 41-302L	A31	OM 42-0876	A33
OM 38-0186	A27	OM 39-0534	A29	OM 41-0308	A31	OM 42-0880	A33
OM 38-0264	A23	OM 39-0536	A29	OM 41-0314	A31	OM 42-0881	A33
OM 38-0268	A23	OM 39-0644	A21	OM 41-0316	A31	OM 42-0882	A33
OM 38-0272	A23	OM 39-0646	A21	OM 41-0333	A31	OM 42-0883	A33
OM 38-0276	A23	OM 39-0648	A21	OM 41-0424	A31	OM 42-0884	A33
OM 38-0280	A23	OM 39-0650	A21	OM 41-0426	A31	OM 42-0885	A33
OM 38-0286	A23	OM 39-0670	Z2	OM 41-0428	A31	OM 42-0890	A33
OM 38-0290	A23	OM 39-0672	Z2	OM 41-0432	A31	OM 42-0891	A33
OM 38-0292	A23	OM 39-0674	Z2	OM 41-0434	A31	OM 42-0892	A33
OM 38-0296	A23	OM 39-0682	Y4	OM 41-0440	A31	OM 42-0893	A33

OM 42-0894	A33	OM 46-0133	E4	OM 46-0335	J2	OM 46-0404	J9
OM 42-0895	A33	OM 46-0134	E4	OM 46-0336	J2	OM 46-0405	J9
OM 42-0901	A33	OM 46-0138	E5	OM 46-0338	J2	OM 46-0407	J9
OM 42-0902	A33	OM 46-0156	E5	OM 46-0340	J2	OM 46-0408	J9
OM 42-0903	A33	OM 46-0184	E4	OM 46-0342	J2	OM 46-0409	J9
OM 42-0904	A33	OM 46-0186	E4	OM 46-0343	J2	OM 46-0410	J9
OM 42-0905	A33	OM 46-0188	E3	OM 46-0344	J2	OM 46-0411	J9
OM 42-0906	A33	OM 46-0206	G6	OM 46-0345	J2	OM 46-0412	J9
OM 43-0105	A19	OM 46-0207	G6	OM 46-0346	J2	OM 46-0413	G13
OM 43-0107	A19	OM 46-0208	G4	OM 46-0347	J2	OM 46-0413S	G13
OM 43-0110	A19	OM 46-0210	G4	OM 46-0348	J2	OM 46-0414	G13
OM 43-0112	A19	OM 46-0211	G6	OM 46-0348C	J2	OM 46-0414S	G13
OM 43-0116	A19	OM 46-0212	G6	OM 46-0349	J2	OM 46-0416	G13
OM 43-0124	A19	OM 46-0213	G7	OM 46-0349C	J2	OM 46-0416S	G13
OM 43-0168	A20	OM 46-0214	G7	OM 46-0350	J2	OM 46-0418	G13
OM 43-0310	A20	OM 46-0215	G7	OM 46-0350C	J2	OM 46-0418S	G13
OM 43-0324	A20	OM 46-0216	G7	OM 46-0351	J2	OM 46-0420	G13
OM 43-0326	A20	OM 46-0217	G8	OM 46-0351C	J2	OM 46-0420S	G13
OM 43-0520	A20	OM 46-0222	G4	OM 46-0352	J2	OM 46-0422	H5
OM 43-0524	A20	OM 46-0224	G4	OM 46-0352C	J2	OM 46-0422S	H5
OM 45-0002	U3	OM 46-0244	G9	OM 46-0353	J2	OM 46-0423	H5
OM 45-0004	U10	OM 46-0245	G9	OM 46-0353C	J2	OM 46-0423S	H5
OM 45-0118	U18	OM 46-0246	G9	OM 46-0354	J2	OM 46-0424	H5
OM 45-0120	U18	OM 46-0248	G9	OM 46-0354C	J2	OM 46-0424S	H5
OM 45-0122	U18	OM 46-0250	G10	OM 46-0355	J2	OM 46-0425	H5
OM 45-0124	U18	OM 46-0252	G10	OM 46-0355C	J2	OM 46-0425S	H5
OM 45-0126	U18	OM 46-0254	G10	OM 46-0356	J2	OM 46-0426	H5
OM 45-0127	U18	OM 46-0256	G10	OM 46-0356C	J2	OM 46-0426S	H5
OM 45-0128	U18	OM 46-0258	G5	OM 46-0358	J2	OM 46-0427	H5
OM 45-0129	U18	OM 46-0260	G5	OM 46-0359	J8	OM 46-0427S	H5
OM 45-0208	U15	OM 46-0262	G5	OM 46-0360	J8	OM 46-0428	H5
OM 45-0210	U15	OM 46-0263	G5	OM 46-0361	J8	OM 46-0428S	H5
OM 45-0300	L4	OM 46-0264	G5	OM 46-0362	J8	OM 46-0429	H5
OM 45-0302	L5, U19	OM 46-0266	G5	OM 46-0363	J8	OM 46-0429S	H5
OM 45-0304	L4, U 19	OM 46-0268	J4	OM 46-0364	J8	OM 46-0430	H5
OM 45-0305	L6	OM 46-0270	J4	OM 46-0365	J8	OM 46-0430S	H5
OM 45-0306	L6	OM 46-0272	J4	OM 46-0366	J8	OM 46-0433	H5
OM 45-0307	L6	OM 46-0274	J4	OM 46-0367	J8	OM 46-0433S	H5
OM 45-0310	L9	OM 46-0276	J4	OM 46-0368	J8	OM 46-0434	H5
OM 45-0312	L8	OM 46-0278	J4	OM 46-0370	J10	OM 46-0434S	H5
OM 45-0314	L8	OM 46-0280	J4	OM 46-0373	J8	OM 46-0435	H5
OM 45-0326	L6a	OM 46-0284	J4	OM 46-0376	J8	OM 46-0435S	H5
OM 45-0366	L19	OM 46-0286	J4	OM 46-0377	J8	OM 46-0436	H5
OM 45-0370	L19	OM 46-0288	J4	OM 46-0378	J8	OM 46-0436S	H5
OM 46-0056	E3	OM 46-0289	J5	OM 46-0379	J8	OM 46-0437	H5
OM 46-0058	E3	OM 46-0290	J5	OM 46-0380	J8	OM 46-0437S	H5
OM 46-0060	A13, E3	OM 46-0291	J5	OM 46-0381	J8	OM 46-0438	H5
OM 46-0076	F7	OM 46-0292	J5	OM 46-0382	J8	OM 46-0438S	H5
OM 46-0077	F7	OM 46-0293	J5	OM 46-0383	J8	OM 46-0439	H5
OM 46-0078	F7	OM 46-0294	J5	OM 46-0384	J8	OM 46-0439S	H5
OM 46-0079	F7	OM 46-0304	J3	OM 46-0387	J9	OM 46-0440	H5
OM 46-0081	F7	OM 46-0306	J3	OM 46-0388	J9	OM 46-0440S	H5
OM 46-0082	F7	OM 46-0310	J3	OM 46-0389	J9	OM 46-0441	H5
OM 46-0083	F7	OM 46-0314	J3	OM 46-0390	J9	OM 46-0441S	H5
OM 46-0084	F7	OM 46-0318	J3	OM 46-0391	J9	OM 46-0448	J7
OM 46-0085	F7	OM 46-0322	J3	OM 46-0392	J9	OM 46-0449	J7
OM 46-0086	F7	OM 46-0328	J3	OM 46-0393	J9	OM 46-0450	J7
OM 46-0087	F7	OM 46-0329	J3	OM 46-0394	J9	OM 46-0451	J7
OM 46-0088	F7	OM 46-0330	J3	OM 46-0395	J9	OM 46-0452	J7
OM 46-0089	F7	OM 46-0331	J3	OM 46-0401	J9	OM 46-0453	J7
OM 46-0090	A13,E2,F7	OM 46-0332	J3	OM 46-0402	J9	OM 46-0454	J7
OM 46-0091	F7	OM 46-0333	J3	OM 46-0403	J9	OM 46-0457	J7

OM 46-0458	J7	OM 46-0547	Y3	OM 46-0653	F6	OM 46-0829	I28
OM 46-0459	J7	OM 46-0550	H2	OM 46-0654	F6	OM 46-0830	I28
OM 46-0460	J7	OM 46-0551	H4	OM 46-0655	F5	OM 46-0832	I28
OM 46-0461	J7	OM 46-0552	H4	OM 46-0656	K1	OM 46-0836	I29
OM 46-0462	J7	OM 46-0553	H4	OM 46-0657	K2	OM 46-0838	I29
OM 46-0463	J7	OM 46-0554	H4	OM 46-0658	K3	OM 46-0840	I31a
OM 46-0466	J7	OM 46-0555	H4	OM 46-0660	K1	OM 46-0841	I30
OM 46-0467	J7	OM 46-0556	H4	OM 46-0661	K1	OM 46-0842	I30
OM 46-0468	J7	OM 46-0557	H4	OM 46-0662	K2	OM 46-0848	I29
OM 46-0476	J7	OM 46-0558	H4	OM 46-0663	K4	OM 46-0849	I31
OM 46-0477	J7	OM 46-0559	H4	OM 46-0664	U25	OM 46-0850	I30
OM 46-0478	J7	OM 46-0560	H1	OM 46-0666	K5	OM 46-0851	I31a
OM 46-0479	J7	OM 46-0561	H1	OM 46-0667	K5	OM 46-0852	I31
OM 46-0487	J7	OM 46-0562	H1	OM 46-0683	M6	OM 46-0854	I31
OM 46-0488	J7	OM 46-0563	H4	OM 46-0684	M6	OM 46-0855	I31 b
OM 46-0489	J7	OM 46-0564	H4	OM 46-0685	M6	OM 46-0858	I29
OM 46-0490	J7	OM 46-0565	H4	OM 46-0686	K3	OM 46-0860	I25
OM 46-0491	J7	OM 46-0566	H4	OM 46-0687	K3	OM 46-0868	I31b
OM 46-0493	J7	OM 46-0567	H4	OM 46-0688	K5	OM 46-0870	I19
OM 46-0495	J7	OM 46-0568	H4	OM 46-0689	K6	OM 46-0872	I19
OM 46-0497	J3	OM 46-0569	H4	OM 46-0690	K5	OM 46-0874	I23
OM 46-0498	J3	OM 46-0570	H4	OM 46-0697	K6	OM 46-0875	I23
OM 46-0499	J3	OM 46-0571	H4	OM 46-0698	K6	OM 46-0880	I16
OM 46-0500	J3	OM 46-0572	S24,BB10	OM 46-0700	J3	OM 46-0884	I16
OM 46-0501	J3	OM 46-0573	S24,BB10	OM 46-0701	J3	OM 46-0891	I9
OM 46-0502	J3	OM 46-0574	S24,BB10	OM 46-0702	J3	OM 46-0892	I9
OM 46-0503	J3	OM 46-0578	S21	OM 46-0703	J3	OM 46-0893	K8
OM 46-0504	J3	OM 46-0582	S31	OM 46-0704	J3	OM 46-0894	K8
OM 46-0505	J4	OM 46-0598	M7	OM 46-0705	F7	OM 46-0895	K8
OM 46-0506	J4	OM 46-0600	M7	OM 46-0706	J3	OM 46-0896	K8
OM 46-0507	J4	OM 46-0601	M5	OM 46-0708	J3	OM 46-0897	K8
OM 46-0508	J4	OM 46-0602	M6	OM 46-0709	J3	OM 46-0898	K8
OM 46-0509	J4	OM 46-0610	M7	OM 46-0730	P5	OM 46-0899	K8
OM 46-0511	H4	OM 46-0612	M7	OM 46-0731	P5	OM 46-0901	G9
OM 46-0511A	H4	OM 46-0613	M7	OM 46-0732	P5	OM 46-0902	G9
OM 46-0512	H4	OM 46-0614	M7	OM 46-0733	P5	OM 46-0903	G9
OM 46-0512A	H4	OM 46-0615	M7	OM 46-0734	P5	OM 46-0904	G9
OM 46-0513	H4	OM 46-0616	M7	OM 46-0735	P3	OM 46-0905	G9
OM 46-0513A	H4	OM 46-0617	M7	OM 46-0736	P2	OM 46-0906	I20
OM 46-0515	H4	OM 46-0619	S30	OM 46-0737	P2	OM 46-0907	I20
OM 46-0515A	H4	OM 46-0621	S12	OM 46-0738	P2	OM 46-0908	I19
OM 46-0517	H4	OM 46-0622	S10	OM 46-0739	P3	OM 46-0909	I20
OM 46-0517A	H4	OM 46-0623	S13	OM 46-0740	P3	OM 46-0910	I20
OM 46-0519	H4	OM 46-0624	S13	OM 46-0741	P5	OM 46-0911	L5
OM 46-0519A	H4	OM 46-0625	S12	OM 46-0742	P4	OM 46-0912	L5
OM 46-0521	H4	OM 46-0626	S17	OM 46-0743	P4	OM 46-0913	G18
OM 46-0521A	H4	OM 46-0628	S18	OM 46-0744	P2	OM 46-0914	G18
OM 46-0523	H4	OM 46-0629	S15	OM 46-0746	P2	OM 46-0915	G18
OM 46-0523A	H4	OM 46-0631	S12	OM 46-0748	P2	OM 46-0916	G17
OM 46-0525	H4	OM 46-0632	S16	OM 46-0762	P5	OM 46-0917	G17
OM 46-0525A	H4	OM 46-0633	S16	OM 46-0766	P5	OM 46-0918	G17
OM 46-0529	H4	OM 46-0635	S18	OM 46-0770	P5	OM 46-0919	J10
OM 46-0529A	H4	OM 46-0637	S29	OM 46-0772	P5	OM 46-0922	I22b
OM 46-0531	H4	OM 46-0643	M6	OM 46-0802	P1	OM 46-0926	I19
OM 46-0531A	H4	OM 46-0644	M6	OM 46-0804	L1, P1	OM 46-0927	I19
OM 46-0538	S1	OM 46-0645	M6	OM 46-0814	P1	OM 47-0010	L3
OM 46-0539	S1	OM 46-0646	M6	OM 46-0818	P2	OM 47-0012	L3
OM 46-0540	S2	OM 46-0647	S12	OM 46-0821	P1	OM 47-0025	L20
OM 46-0542	S1	OM 46-0649	S11	OM 46-0823	I28	OM 47-0030	L20
OM 46-0543	S1	OM 46-0650	F6	OM 46-0826	I28	OM 47-0054	L12
OM 46-0544	Y3	OM 46-0651	S11	OM 46-0827	I28	OM 47-0056	L12
OM 46-0545	Y3	OM 46-0652	F6	OM 46-0828	P1	OM 47-0062	L12

OM 47-0064	L12	OM 47-0172	L13	OM 47-0464	N9	OM 47-0676	O14
OM 47-0068	L12	OM 47-0173	L13	OM 47-0472	N9	OM 47-0678	O14
OM 47-0070	L13	OM 47-0190	L17	OM 47-0473	N7	OM 47-0680	O14
OM 47-0072	L7	OM 47-0192	L17	OM 47-0474	N10	OM 47-0682	O14
OM 47-0074	L7	OM 47-0194	L17	OM 47-0476	N10	OM 47-0685	O13, O17
OM 47-0076	L7	OM 47-0196	L17	OM 47-0478	N10	OM 47-0686	O13, O17
OM 47-0078	L12	OM 47-0198	L7	OM 47-0480	N7	OM 47-0687	O13, O17
OM 47-0080	L12	OM 47-0200	L8	OM 47-0482	N7	OM 47-0688	O13, O17
OM 47-0082	L12	OM 47-0202	L17	OM 47-0484	N7	OM 47-0689	O14, O17
OM 47-0084	L13	OM 47-0204	L16	OM 47-0486	N8	OM 47-0700	O10
OM 47-0086	L20	OM 47-0206	L16	OM 47-0487	N8	OM 47-0702	O10
OM 47-0087	L20	OM 47-0208	L16	OM 47-0488	N8	OM 47-0703	O10
OM 47-0088	L20	OM 47-0212	L16	OM 47-0489	N8	OM 47-0704	O10
OM 47-0089	L19	OM 47-0240	N1	OM 47-0490	N8	OM 47-0707	O8
OM 47-0090	L14	OM 47-0242	N1	OM 47-0492	N8	OM 47-0708	O8
OM 47-0092	L14	OM 47-0244	N1	OM 47-0494	N8	OM 47-0709	O8
OM 47-0094	L14	OM 47-0252	N1	OM 47-0495	N8	OM 47-0710	O4
OM 47-0096	L14	OM 47-0253	N1	OM 47-0496	N8	OM 47-0712	O4
OM 47-0098	L14	OM 47-0254	N3	OM 47-0497	N8	OM 47-0714	O4
OM 47-0100	L10	OM 47-0256	N3	OM 47-0498	N8	OM 47-0730	O4
OM 47-0101	L10	OM 47-0258	N3	OM 47-0499	N8	OM 47-0732	O4
OM 47-0102	L8	OM 47-0260	N3	OM 47-0520	N5	OM 47-0734	O4
OM 47-0103	L9	OM 47-0262	N1	OM 47-0522	N5	OM 47-0740	O4
OM 47-0105	L6a	OM 47-0263	N2	OM 47-0523	N4	OM 47-0742	O4
OM 47-0107	L6a	OM 47-0264	N2	OM 47-0524	N5	OM 47-0744	O4
OM 47-0108	L18	OM 47-0266	N2	OM 47-0525	N5	OM 47-0760	O4
OM 47-0109	L18	OM 47-0267	N2	OM 47-0526	N5	OM 47-0762	O4
OM 47-0110	L18	OM 47-0268	N2	OM 47-0527	N5	OM 47-0764	O4
OM 47-0112	L18	OM 47-0270	M1	OM 47-0528	N5	OM 47-0780	O4
OM 47-0114	L18	OM 47-0272	M1	OM 47-0531	N5	OM 47-0782	O4
OM 47-0115	L20	OM 47-0274	N3	OM 47-0532	N4	OM 47-0784	O4
OM 47-0116	L18	OM 47-0275	N3	OM 47-0533	N4	OM 47-0800	O4
OM 47-0118	L18	OM 47-0276	N6	OM 47-0534	N4	OM 47-0802	O4
OM 47-0119	L3	OM 47-0278	N6	OM 47-0538	M3	OM 47-0804	O4
OM 47-0120	L15	OM 47-0284	N6	OM 47-0540	M3	OM 47-0840	O4
OM 47-0122	L15	OM 47-0285	N6	OM 47-0541	M1	OM 47-0842	O4
OM 47-0124	L15	OM 47-0286	N2	OM 47-0542	M3	OM 47-0844	O4
OM 47-0126	L15	OM 47-0302	N7	OM 47-0546	M2	OM 47-0853	O14
OM 47-0127	L6	OM 47-0304	N7	OM 47-0550	M2	OM 47-0855	O13
OM 47-0105	L6	OM 47-0306	N7	OM 47-0553	N4	OM 47-0856	O13
OM 47-0128	L6, U20	OM 47-0308	N6	OM 47-0555	M5	OM 47-0857	O13
OM 47-0129	L5	OM 47-0310	N6	OM 47-0557	M5	OM 47-0858	O6
OM 47-0130	L2	OM 47-0366	M4	OM 47-0558	N4	OM 47-0860	O6
OM 47-0131	L2	OM 47-0370	M4	OM 47-0560	N4	OM 47-0862	O6
OM 47-0132	L5	OM 47-0374	M4	OM 47-0562	N4	OM 47-0864	O6
OM 47-0133	L4	OM 47-0380	N10	OM 47-0610	O15	OM 47-0866	O6
OM 47-0134	L6	OM 47-0382	N10	OM 47-0612	O15	OM 47-0868	O6
OM 47-0135	L4	OM 47-0384	N10	OM 47-0614	O15	OM 47-0870	O6
OM 47-0135L	L6a	OM 47-0386	N10	OM 47-0616	O15	OM 47-0872	O6
OM 47-0136	L4	OM 47-0396	N10	OM 47-0644	O14	OM 47-0873	O6
OM 47-0137	L4, U20	OM 47-0398	M2	OM 47-0645	O14	OM 47-0874	O6
OM 47-0138	L2, U20	OM 47-0400	M2	OM 47-0646	O14	OM 47-0875	O6
OM 47-0139	L1, U20	OM 47-0402	M2	OM 47-0648	O14	OM 47-0876	O6
OM 47-0140	L11	OM 47-0404	M2	OM 47-0649	O14	OM 47-0878	O6
OM 47-0154	L11	OM 47-0406	M2	OM 47-0650	O14	OM 47-0879	O13
OM 47-0156	L11	OM 47-0408	M2	OM 47-0652	O14	OM 47-0880	U15
OM 47-0160	L11	OM 47-0410	M2	OM 47-0654	O14	OM 47-0881	I7
OM 47-0164	L11	OM 47-0412	M2	OM 47-0656	O14	OM 47-0890	S24a
OM 47-0166	L11	OM 47-0458	N9	OM 47-0657	O14	OM 47-0896	S3
OM 47-0167	L11	OM 47-0460	N9	OM 47-0658	O14	OM 47-0897	S3
OM 47-0168	L11	OM 47-0461	N9	OM 47-0670	O14	OM 47-0901	S2
OM 47-0170	L3	OM 47-0462	N9	OM 47-0674	O14	OM 47-0902	U5

OM 47-0903	S2	OM 47-0975	U8	OM 48-0080	U1	OM 48-0248	S21
OM 47-0904	U5	OM 47-0976	U8	OM 48-0081	U1	OM 48-0250	S23
OM 47-0906	U16	OM 47-0977	U9	OM 48-0082	U1	OM 48-0252	M8
OM 47-0909	U15	OM 47-0978	U9	OM 48-0085	U1	OM 48-0252P	M8
OM 47-0910	U15	OM 47-0979	U1	OM 48-0086	U1	OM 48-0253	S23
OM 47-0911	U16	OM 47-0980	U9	OM 48-0100	U2	OM 48-0254	S22
OM 47-0912	U16	OM 47-0981	U1	OM 48-0102	U4	OM 48-0256	S22
OM 47-0914	T8,U16	OM 47-0982	U8	OM 48-0104	U4	OM 48-0257	S22
OM 47-0915	U21	OM 47-0983	U11	OM 48-0106	U4	OM 48-0258	S22
OM 47-0916	U21	OM 47-0985	U7	OM 48-0108	U4	OM 48-0259	S23
OM 47-0917	U21	OM 47-0986	U1	OM 48-0110	U4	OM 48-0262	S24
OM 47-0918	U21	OM 47-0988	O13	OM 48-0112	U4	OM 48-0270	S34
OM 47-0919	U21	OM 47-0989	O13	OM 48-0114	U4	OM 48-0272	S34
OM 47-0920	U3	OM 47-0990	O13	OM 48-0116	U4	OM 48-0274	S34
OM 47-0921	U16	OM 47-0991	O13	OM 48-0118	U4	OM 48-0299	W3
OM 47-0922	U3	OM 47-0992	O13	OM 48-0120	U4	OM 48-0302	W1
OM 47-0924	U3	OM 47-0993	O13	OM 48-0122	U4	OM 48-0303	G18
OM 47-0925	U22	OM 47-0994	O13	OM 48-0129	U2	OM 48-0310	W2
OM 47-0926	U3	OM 47-0995	O13	OM 48-0130	U2	OM 48-0312	W2
OM 47-0927	U22	OM 47-0996	O13	OM 48-0132	U2	OM 48-0313	W3
OM 47-0928	U22	OM 47-0997	O13	OM 48-0134	U2	OM 48-0314	W1
OM 47-0929	U23	OM 47-0998	O13	OM 48-0135	U2	OM 48-0315	W2
OM 47-0930	U15	OM 47-0999	O13	OM 48-0136	U2	OM 48-0320	S29
OM 47-0931	U22	OM 48-0002	U6	OM 48-0137	U2	OM 48-0322	S30
OM 47-0932	S20, U23	OM 48-0004	U7	OM 48-0138	U2	OM 48-0324	S30
OM 47-0934	U5, W1	OM 48-0005	U7	OM 48-0140	U2	OM 48-0326	S34
OM 47-0935	U5, W1	OM 48-0016	O13	OM 48-0142	U2	OM 48-0328	S34
OM 47-0936	U5, W1	OM 48-0017	O13	OM 48-0143	U2	OM 48-0330	S34
OM 47-0940	U5, W1	OM 48-0018	O13	OM 48-0158	I1	OM 48-0331	G19
OM 47-0941	U18	OM 48-0019	O13	OM 48-0161	I1	OM 48-0332	G20
OM 47-0942	U18	OM 48-0020	O13	OM 48-0180	I26	OM 48-0333	G19
OM 47-0943	U18	OM 48-0021	O13	OM 48-0184	I26	OM 48-0334	G19
OM 47-0944	U18	OM 48-0022	O13	OM 48-0192	I27	OM 48-0335	G19
OM 47-0945	U18	OM 48-0023	O13	OM 48-0194	I27	OM 48-0336	G17
OM 47-0946	U19	OM 48-0024	O13	OM 48-0196	I27	OM 48-0337	G17
OM 47-0947	U19	OM 48-0025	O13	OM 48-0198	I27	OM 48-0338	G17
OM 47-0948	U19	OM 48-0026	O13	OM 48-0200	I27	OM 48-0339	G17
OM 47-0950	U10	OM 48-0027	O13	OM 48-0201	I26	OM 48-0340	G17
OM 47-0951	U10	OM 48-0028	O13	OM 48-0202	I26	OM 48-0341	G17
OM 47-0952	U12	OM 48-0029	O13,O17	OM 48-0204	I26	OM 48-0342	G20
OM 47-0953	U10	OM 48-0030	O16	OM 48-0206	I26	OM 48-0343	G20
OM 47-0954	U10	OM 48-0032	O16	OM 48-0208	I16	OM 48-0344	G20
OM 47-0955	U12	OM 48-0033	O16	OM 48-0210	I16	OM 48-0345	G20
OM 47-0956	U12	OM 48-0050	U1	OM 48-0212	I16	OM 48-0348	U10
OM 47-0957	U12	OM 48-0051	U1	OM 48-0214	I16	OM 48-0349	U13
OM 47-0958	U12	OM 48-0052	U1	OM 48-0217	I43	OM 48-0350	U13
OM 47-0959	U12	OM 48-0054	U1	OM 48-0218	I43	OM 48-0352	U13
OM 47-0960	U5	OM 48-0057	U1	OM 48-0220	I39	OM 48-0353	U13
OM 47-0961	U11	OM 48-0058	U1	OM 48-0223	D12,135	OM 48-0354	U13
OM 47-0962	U15	OM 48-0060	U1	OM 48-0226	I43	OM 48-0355	U11
OM 47-0963	U15	OM 48-0061	U1	OM 48-0228	I43	OM 48-0356	U13
OM 47-0964	U15	OM 48-0063	U1	OM 48-0230	I43	OM 48-0358	U13
OM 47-0965	U6	OM 48-0066	U1	OM 48-0234	I7	OM 48-0360	U13
OM 47-0966	U6	OM 48-0067	U1	OM 48-0237	I7	OM 48-0362	U13
OM 47-0967	U6	OM 48-0068	U1	OM 48-0239	M8,U19	OM 48-0364	U12
OM 47-0968	U6	OM 48-0069	U1	OM 48-0240	M8, U19	OM 48-0365	U11
OM 47-0969	U8	OM 48-0070	U1	OM 48-0241	M8,U19	OM 48-0368	U12
OM 47-0970	U7	OM 48-0071	U1	OM 48-0242	S20	OM 48-0370	S4
OM 47-0971	U7	OM 48-0073	U1	OM 48-0243	S22	OM 48-0372	S3
OM 47-0972	U6	OM 48-0076	U1	OM 48-0244	U22	OM 48-0374	S2
OM 47-0973	U7	OM 48-0077	U1	OM 48-0245	S21	OM 48-0378	S19
OM 47-0974	U7	OM 48-0079	U1	OM 48-0246	S21	OM 48-0380	S32

OM 48-0382	S32	OM 48-0488	U14	OM 49-0063	J9	OM 49-0212	A26
OM 48-0384	S32	OM 48-0489	U14	OM 49-0064	J9	OM 49-0216	A26
OM 48-0386	S32	OM 48-0490	U14	OM 49-0065	J9	OM 49-0246	J6
OM 48-0388	S32	OM 48-0578	G21	OM 49-0066	J9	OM 49-0248	J6
OM 48-0390	S5	OM 48-0579	G21	OM 49-0067	J9	OM 49-0250	J6
OM 48-0390P	S5	OM 48-0580	G21	OM 49-0068	J9	OM 49-0252	J6
OM 48-0392	S5	OM 48-0583	G21	OM 49-0073	J9	OM 49-0254	J6
OM 48-0392P	S5	OM 48-0588	G18	OM 49-0074	J9	OM 49-0256	J6
OM 48-0394	S5	OM 48-0600	S25	OM 49-0075	J9	OM 49-0258	J6
OM 48-0400	BB7	OM 48-0602	S25	OM 49-0076	J9	OM 49-0260	J6
OM 48-0402	BB8	OM 48-0604	S24	OM 49-0077	J9	OM 49-0262	J6
OM 48-0404	BB9	OM 48-0605	S24	OM 49-0078	J9	OM 49-0264	J6
OM 48-0410	BB4	OM 48-0606	S26	OM 49-0079	J9	OM 49-0266	J6
OM 48-0414	BB4	OM 48-0608	S25	OM 49-0080	J9	OM 49-0268	J6
OM 48-0415	S7	OM 48-0610	S26	OM 49-0081	J9	OM 49-0310	G5
OM 48-0420	S7	OM 48-0612	S28	OM 49-0082	J9	OM 49-0311	G5
OM 48-0421	S7	OM 48-0614	S28	OM 49-0084	J10	OM 49-0312	G5
OM 48-0422	S7	OM 48-0616	S28	OM 49-0090	Z1	OM 49-0313	G5
OM 48-0423	S7	OM 48-0620	S28	OM 49-0092	Z1	OM 49-0320	G2, 15
OM 48-0425	S6	OM 48-0622	S28	OM 49-0093	Z1	OM 49-0322	G3
OM 48-0426	S6	OM 48-0625	S27	OM 49-0110	H4	OM 49-0324	G3
OM 48-0427	S6	OM 48-0626	S27	OM 49-0111	H4	OM 49-0326	G3
OM 48-0428	S6	OM 48-0627	S27	OM 49-0112	H4	OM 49-0339	G11
OM 48-0429	S6	OM 48-0630	S27	OM 49-0113	H4	OM 49-0340	G11
OM 48-0430	S6	OM 48-0631	S27	OM 49-0114	H4	OM 49-0342	G11
OM 48-0431	S6	OM 48-0632	S27	OM 49-0115	H4	OM 49-0344	G11
OM 48-0432	S6	OM 48-0633	S27	OM 49-0116	H4	OM 49-0346	G11
OM 48-0433	S6	OM 48-0634	S27	OM 49-0117	H4	OM 49-0350	J10
OM 48-0434	S6	OM 48-0635	S27	OM 49-0118	H4	OM 49-0351	J10
OM 48-0435	S6	OM 49-0002	J8	OM 49-0120	H3	OM 49-0352	J10
OM 48-0436	S6	OM 49-0004	J8	OM 49-0120A	H3	OM 49-0353	J10
OM 48-0437	S6	OM 49-0006	J8	OM 49-0121	H3	OM 49-0354	J10
OM 48-0438	S6	OM 49-0008	J8	OM 49-0121A	H3	OM 49-0355	J10
OM 48-0440	S8	OM 49-0009	H4	OM 49-0122	H3	OM 49-0356	J10
OM 48-0441	S8	OM 49-0010	J8	OM 49-0122A	H3	OM 49-0357	J10
OM 48-0442	S8	OM 49-0012	J8	OM 49-0123	H3	OM 49-0358	J10
OM 48-0443	S8	OM 49-0014	J8	OM 49-0123A	H3	OM 49-0359	J10
OM 48-0450	S8	OM 49-0016	J8	OM 49-0124	H3	OM 49-0360	J10
OM 48-0451	S8	OM 49-0018	J8	OM 49-0124A	H3	OM 49-0361	J10
OM 48-0454	S9	OM 49-0020	J8	OM 49-0125	H3	OM 49-0362	J10
OM 48-0455	S9	OM 49-0022	J8	OM 49-0125A	H3	OM 49-0363	J10
OM 48-0456	S9	OM 49-0024	J8	OM 49-0126	H3	OM 49-0403	H2
OM 48-0457	S9	OM 49-0030	J11	OM 49-0126A	H3	OM 49-0404	H2
OM 48-0458	S9	OM 49-0032	J11	OM 49-0150	H4	OM 49-0405	H2
OM 48-0459	S9	OM 49-0034	J11	OM 49-0151	H4	OM 49-0413	H2
OM 48-0460	S9	OM 49-0036	J11	OM 49-0152	H4	OM 49-0414	H2
OM 48-0461	S9	OM 49-0040	J5	OM 49-0153	H4	OM 49-0415	H2
OM 48-0462	S9	OM 49-0041	J5	OM 49-0154	H4	OM 49-0423	H2
OM 48-0463	S9	OM 49-0042	J5	OM 49-0155	H4	OM 49-0424	H2
OM 48-0464	S9	OM 49-0043	J5	OM 49-0156	H4	OM 49-0425	H2
OM 48-0465	S6	OM 49-0044	J5	OM 49-0157	H4	OM 49-0433	H2
OM 48-0466	S6	OM 49-0045	J5	OM 49-0158	H4	OM 49-0434	H2
OM 48-0467	S6	OM 49-0050	J5	OM 49-0168	A26	OM 49-0435	H2
OM 48-0468	S6	OM 49-0051	J5	OM 49-0170	A26	OM 49-0450	H6
OM 48-0469	S6	OM 49-0052	J5	OM 49-0172	A26	OM 49-0452	H6
OM 48-0481	U14	OM 49-0053	J5	OM 49-0180	A26	OM 49-0454	H6
OM 48-0482	U14	OM 49-0054	J5	OM 49-0182	A26	OM 49-0456	H6
OM 48-0483	U14	OM 49-0055	J5	OM 49-0184	A26	OM 49-0458	H6
OM 48-0484	U14	OM 49-0059	J9	OM 49-0200	H2	OM 49-0460	H6
OM 48-0485	U14	OM 49-0060	J9	OM 49-0202	H2	OM 49-0574	H3
OM 48-0486	U14	OM 49-0061	J9	OM 49-0204	H2	OM 49-0576	H3
OM 48-0487	U14	OM 49-0062	J9	OM 49-0210	A26	OM 49-0578	H3

OM 49-0580	H3	OM 51-0060	I10	OM 51-0776	I9	OM 52-0417	I34
OM 49-0582	H3	OM 51-0061	I10	OM 52-0040	I2	OM 52-0418	I34
OM 49-0584	H3	OM 51-0078	I17	OM 52-0042	I2	OM 52-0420	I34
OM 49-0602	A16	OM 51-0080	I17	OM 52-0050	I1	OM 52-0422	I34
OM 49-0604	A16	OM 51-0100	I8	OM 52-0055	I1	OM 52-0425	I33
OM 49-0606	A16	OM 51-0104	I8	OM 52-0060	I2	OM 52-0426	I33
OM 49-0608	A16	OM 51-0108	I8	OM 52-0064	I2	OM 52-0427	I33
OM 49-0610	A16	OM 51-0112	I8	OM 52-0068	I2	OM 52-0428	I33
OM 49-0618	A16	OM 51-0158	I16	OM 52-0076	I4	OM 52-0442	I39
OM 49-0620	A16	OM 51-0162	I16	OM 52-0082	I3	OM 52-0444	I39
OM 49-0622	A16	OM 51-0164	I16	OM 52-0086	I3	OM 52-0458	I31d
OM 49-0624	A16	OM 51-0200	I15	OM 52-0087	I3	OM 52-0460	I31d
OM 49-0626	A16	OM 51-0202	I15	OM 52-0088	I4	OM 52-0470	I47
OM 49-0628	A19	OM 51-0204	I15	OM 52-0090	I4	OM 52-0472	I47
OM 49-0629	A19	OM 51-0206	I15	OM 52-0092	I4	OM 52-0474	I47
OM 49-0630	J1	OM 51-0210	I15	OM 52-0093	I4	OM 52-0476	I45
OM 49-0632	J1	OM 51-0212	I15	OM 52-0094	I4	OM 52-0484	I46
OM 49-0634	J1	OM 51-0214	I15	OM 52-0096	I5	OM 52-0486	I46
OM 49-0640	J1	OM 51-0216	I11	OM 52-0116	I5	OM 52-0488	I46
OM 49-0644	J1	OM 51-0218	I11	OM 52-0118	I5	OM 52-0490	I46
OM 49-0648	J1	OM 51-0220	I11	OM 52-0122	I5	OM 52-0492	I37
OM 49-0652	J1	OM 51-0222	I11	OM 52-0124	I5	OM 52-0494	I37
OM 49-0656	J1	OM 51-0230	I11	OM 52-0128	I5	OM 52-0498	I38
OM 49-0660	J1	OM 51-0232	I11	OM 52-0130	I5	OM 52-0502	I38
OM 49-0664	J1	OM 51-0234	I11	OM 52-0156	I3	OM 52-0504	I38
OM 49-0668	J1	OM 51-0236	I11	OM 52-0158	I3	OM 52-0506	I38
OM 49-0672	J1	OM 51-0238	I11	OM 52-0162	I3	OM 52-0518	I38
OM 49-0676	J1	OM 51-0240	I11	OM 52-0164	I3	OM 52-0522	I38
OM 49-0680	J1	OM 51-0242	I11	OM 52-0166	I3	OM 52-0524	I38
OM 49-0708	S24b	OM 51-0245	I12	OM 52-0172	I3	OM 52-0526	I38
OM 49-0724	S4, U22	OM 51-0247	I12	OM 52-0174	I3	OM 52-0530	I38
OM 49-0734	S10	OM 51-0249	I12	OM 52-0176	I3	OM 52-0532	I38
OM 49-0735	S11	OM 51-0251	I12	OM 52-0182	I3	OM 52-0534	I38
OM 49-0736	S14	OM 51-0253	I12	OM 52-0184	I3	OM 52-0536	I38
OM 49-0738	S14	OM 51-0255	I13	OM 52-0188	I3	OM 52-0538	I38
OM 49-0740	S13	OM 51-0257	I13	OM 52-0192	I3	OM 52-0540	I38
OM 49-0740P	S13	OM 51-0259	I13	OM 52-0198	I3	OM 52-0542	I38
OM 49-0750	K7	OM 51-0261	I13	OM 52-0202	I3	OM 52-0544	I38
OM 49-0751	K7	OM 51-0263	I13	OM 52-0204	I3	OM 52-0546	I37
OM 49-0752	K7	OM 51-0372	I9	OM 52-0206	I3	OM 52-0548	I37
OM 49-0753	K7	OM 51-0376	I9	OM 52-0208	I3	OM 52-0554	I41
OM 49-0754	K7	OM 51-0388	I14	OM 52-0212	I3	OM 52-0556	I38
OM 49-0760	K2	OM 51-0468	I5	OM 52-0214	I3	OM 52-0558	I38
OM 49-0761	K1	OM 51-0480	I14	OM 52-0216	I3	OM 52-0560	I38
OM 49-0762	K4	OM 51-0482	I14	OM 52-0254	I8	OM 52-0562	I41
OM 49-0763	K3	OM 51-0494	I14	OM 52-0258	I8	OM 52-0564	I41
OM 49-0764	K2	OM 51-0498	I14	OM 52-0262	I8	OM 52-0566	I41
OM 49-0765	K1	OM 51-0500	I14	OM 52-0264	I8	OM 52-0574	I38
OM 49-0766	K4	OM 51-0502	I12	OM 52-0266	I8	OM 52-0576	I38
OM 49-0767	K4	OM 51-0520	I6	OM 52-0268	I8	OM 52-0578	I38
OM 49-0770	K6	OM 51-0521	I7	OM 52-0272	I8	OM 52-0580	I38
OM 49-0771	K6	OM 51-0523	I8	OM 52-0274	I8	OM 52-0582	I38
OM 49-0772	K6	OM 51-0528	I5	OM 52-0276	I8	OM 52-0584	I38
OM 49-0773	K6	OM 51-0530	I6	OM 52-0282	I17	OM 52-0586	I38
OM 49-0800	S15	OM 51-0532	I6	OM 52-0292	I17	OM 52-0602	I48
OM 49-0802	S4	OM 51-0534	I6	OM 52-0294	I17	OM 52-0703S	I42
OM 49-0810	S31	OM 51-0752	I9	OM 52-0296	I17	OM 52-0703L	I42
OM 49-0812	U24	OM 51-0755	I9	OM 52-0298	I17	OM 52-0704	I42
OM 49-0820	S3	OM 51-0766	I9	OM 52-0358	I49	OM 52-0704F	I42
OM 49-0910	L20	OM 51-0768	I9	OM 52-0380	I49	OM 52-0704L	I42
OM 49-0920	S23	OM 51-0770	I9	OM 52-0414	I34	OM 52-0704P	I42
OM 51-0059	I10	OM 51-0772	I9	OM 52-0416	I34	OM 52-0704S	I42

OM 52-0704W	I42	OM 53-0380	A27	OM 55-0401	K3	OM 55-0499	I40
OM 52-0705L	I42	OM 53-0382	A27	OM 55-0414	I6	OM 55-0500	I40
OM 52-0705S	I42	OM 53-0384	A27	OM 55-0415	I6	OM 55-0510	H8
OM 52-0705SR	I42	OM 53-0404	A26	OM 55-0416	I6	OM 55-0523	H7
OM 52-0706L	I42	OM 53-0408	A26	OM 55-0417	I6	OM 55-0532	H7
OM 52-0706LR	I42	OM 53-0420	A26	OM 55-0420	I6	OM 55-0533	H7
OM 52-0706S	I42	OM 53-0422	A26	OM 55-0421	I6	OM 55-0543	H7
OM 52-0707L	I42	OM 53-0450	A38	OM 55-0422	I6	OM 55-0556	H7
OM 52-0707S	I42	OM 53-0456	A38	OM 55-0424	I7	OM 55-0566	H8
OM 52-0707SR	I42	OM 540338	I1	OM 55-0426	I6	OM 55-0573	H8
OM 52-0708L	I42	OM 54-0342	I1	OM 55-0428	I6	OM 55-0576	H9
OM 52-0708LR	I42	OM 54-0346	I1	OM 55-0430	I41	OM 55-0577	H9
OM 52-0708S	I42	OM 54-0348	I1	OM 55-0431	I41	OM 55-0578	H9
OM 52-0709L	I42	OM 54-0350	I1	OM 55-0432	I41	OM 55-0586	H7
OM 52-0709LR	I42	OM 54-0366	I2	OM 55-0438	I37	OM 55-0593	H7
OM 52-0709S	I42	OM 54-0368	I2	OM 55-0440	I41	OM 55-0610	G12
OM 52-0709SR	I42	OM 54-0372	I2	OM 55-0441	I41	OM 55-0612	G12
OM 52-0711L	I42	OM 55-0170	Q9	OM 55-0445	I50	OM 55-0614	G12
OM 52-0711S	I42	OM 55-0172	Q9	OM 55-0446	I50	OM 55-0620	G12
OM 52-0711 SR	I42	OM 55-0173	Q9	OM 55-0447	I50	OM 55-0630	J12
OM 52-0765	I36	OM 55-0300	G14	OM 55-0448	I50	OM 55-0640	G14
OM 52-0768	I36	OM 55-0302	G14	OM 55-0449	I50	OM 55-0642	J12
OM 52-0769	I36	OM 55-0304	I7	OM 55-0450	I50	OM 55-0644	G14
OM 52-0770	I36	OM 55-0306	G8	OM 55-0451	I50	OM 55-0654	G3
OM 52-0771	I36	OM 55-0329	G15	OM 55-0452	I50	OM 55-0662	G2
OM 52-0773	I52a	OM 55-0330	G15	OM 55-0453	I50	OM 55-0664	G2
OM 52-0774	I52a	OM 55-0331	G15	OM 55-0454	I50	OM 55-0676	K7
OM 52-0775	I52a	OM 55-0332	G15	OM 55-0456	I50	OM 55-0680	H5
OM 52-0776	I36	OM 55-0333	G15	OM 55-0457	I50	OM 55-0681	H5
OM 52-0778	I36	OM 55-0334	G15	OM 55-0458	I50	OM 55-0682	H5
OM 52-0780	I36	OM 55-0335	G15	OM 55-0459	I50	OM 55-0684	H5
OM 52-0782	I43	OM 55-0336	G15	OM 55-0460	I50	OM 55-0685	H5
OM 52-0792	I52a	OM 55-0337	G15	OM 55-0461	I50	OM 55-0686	H5
OM 52-0793	I52a	OM 55-0338	G15	OM 55-0462	I50	OM 55-0690	O10
OM 52-0794	I52a	OM 55-0339	G15	OM 55-0463	I50	OM 55-0691	O10
OM 52-0795	I52a	OM 55-0340	G15	OM 55-0464	I50	OM 55-0693	O10
OM 53-0040	W2	OM 55-0341	G15	OM 55-0465	I50	OM 55-0694	O10
OM 53-0042	W2	OM 55-0342	G15	OM 55-0466	I50	OM 55-0762	O11
OM 53-0064	A8	OM 55-0343	G15	OM 55-0467	I50	OM 55-0763	O11
OM 53-0066	A8	OM 55-0344	G15	OM 55-0468	I50	OM 55-0767	O11
OM 53-0068	A8	OM 55-0345	G15	OM 55-0469	I50	OM 55-0777	O11
OM 53-0072	A8	OM 55-0346	G15	OM 55-0471	I51	OM 55-0782	O18
OM 53-0080	A8	OM 55-0347	G15	OM 55-0472	I51	OM 55-0788	O18
OM 53-0084	A8	OM 55-0348	G15	OM 55-0473	I51	OM 55-0790	O18
OM 53-0138	A8	OM 55-0370	K9	OM 55-0474	I51	OM 55-0798	G12
OM 53-0160	A8	OM 55-0371	K9	OM 55-0475	I51	OM 55-0800	O7
OM 53-0164	A8	OM 55-0372	K9	OM 55-0476	I51	OM 55-0813	O15
OM 53-0168	A8	OM 55-0373	K9	OM 55-0480	I44	OM 55-0815	O15
OM 53-0172	A8	OM 55-0374	K9	OM 55-0481	I44	OM 55-0823	O15
OM 53-0174	A8	OM 55-0375	K9	OM 55-0482	I44	OM 55-0825	O15
OM 53-0176	A8	OM 55-0376	K9	OM 55-0483	I44	OM 55-0842	O7
OM 53-0265	A8	OM 55-0377	K9	OM 55-0484	I44	OM 55-0856	O9
OM 53-0267	A8	OM 55-0378	K9	OM 55-0485	I44	OM 55-0858	O8
OM 53-0316	A9	OM 55-0384	K10	OM 55-0486	I44	OM 55-0860	O9
OM 53-0318	A9	OM 55-0385	K10	OM 55-0487	I44	OM 55-0891	O12
OM 53-0330	A5	OM 55-0386	K10	OM 55-0488	I44	OM 55-0892	O12
OM 53-0331	A5	OM 55-0387	K10	OM 55-0490	I44	OM 55-0895	O12
OM 53-0332	A5	OM 55-0388	K10	OM 55-0492	I44	OM 55-0898	O12
OM 53-0333	A5	OM 55-0389	K10	OM 55-0495	I44	OM 55-0901	O12
OM 53-0368	A26	OM 55-0390	K10	OM 55-0496	I44	OM 55-0904	O12
OM 53-0372	A26	OM 55-0391	K10	OM 55-0497	I37	OM 55-0905	O12
OM 53-0374	A26	OM 55-0400	K3	OM 55-0498	I40	OM 55-0906	O12

OM 55-0908	O12	OM 58-0066	F4	OM 62-0411	O20	OM 69-0465	D8
OM 55-0909	O12	OM 58-0068	F4	OM 62-0412	O20	OM 69-0468	D8
OM 55-0910	O12	OM 58-0070	F1	OM 62-0413	O20	OM 69-0478	D8
OM 55-0911	O12	OM 58-0072	F4	OM 62-0414	O20	OM 69-0480	D8
OM 55-0912	O12	OM 58-0073	F4	OM 62-0415	O20	OM 69-0484	D8
OM 55-0913	O12	OM 58-0075	G3	OM 62-0221	O20	OM 69-0488	D7
OM 55-0914	O12	OM 58-0076	G3	OM 62-0222	O20	OM 69-0492	D7
OM 55-0915	O12	OM 58-0077	I2	OM 62-0223	O20	OM 69-0495	D7
OM 55-0916	O12	OM 58-0083	I2	OM 62-0224	O20	OM 69-0498	D7
OM 55-0917	O12	OM 58-0085	G4	OM 62-0225	O20	OM 69-0502	D7
OM 55-0918	O12	OM 58-0088	I2	OM 67-0164	A5	OM 69-0518	D7
OM 55-0919	O12	OM 58-0091	I2	OM 67-0166	A5	OM 69-0524	D8
OM 55-0925	O12	OM 58-0092	I2	OM 67-0168	A5	OM 69-0528	D8
OM 55-0926	O12	OM 58-0093	I2	OM 67-0170	A5	OM 69-0530	D8, F1
OM 55-0927	O12	OM 58-0094	I2	OM 67-0172	A5	OM 69-0534	D8, F1
OM 55-0928	O12	OM 58-0096	M5	OM 67-0174	A5	OM 69-0538	D7, F1
OM 55-0930	O12	OM 58-0097	M5	OM 68-0026	A38	OM 69-0540	F2
OM 55-0929	O12	OM 58-0098	M5	OM 69-0106	A9, D6	OM 69-0541	F2
OM 55-0935	O5	OM 58-0100	J4	OM 69-0258	D5	OM 69-0542	F2
OM 55-0936	O5	OM 58-0102	J4	OM 69-0276	D2	OM 69-0543	F2
OM 55-0937	O5	OM 58-0104	J4	OM 69-0278	D2	OM 69-0544	F3
OM 55-0938	O5	OM 58-0106	G4	OM 69-0290	D2	OM 69-0545	F3
OM 55-0940	O5	OM 58-0108	G4	OM 69-0291	D2	OM 69-0546	F3
OM 55-0941	O5	OM 58-0110	G5	OM 69-0292	D2	OM 69-0547	F4
OM 55-0942	O5	OM 58-0112	G5	OM 69-0293	D2	OM 69-0549	F3
OM 55-0946	O5	OM 58-0228	A34	OM 69-0294	D2	OM 69-0557	D8
OM 55-0947	O5	OM 58-0230	A34	OM 69-0295	D2	OM 69-0560	D8
OM 55-0948	O5	OM 58-0240	I49	OM 69-0316	D1, M1	OM 69-0562	D8
OM 55-0949	O5	OM 58-0500	A22	OM 69-0320	D1, M1	OM 69-0568	D8
OM 55-0952	O5	OM 58-0502	A22	OM 69-0321	D1, M1	OM 69-0579	D8
OM 55-0953	O5	OM 59-0064	A19	OM 69-0322	D1, M1	OM 69-0590	D8
OM 55-0954	O5	OM 59-0066	A19	OM 69-0323	D1, M1	OM 69-0595	D9
OM 55-0960	O5	OM 59-0111	O19	OM 69-0324	D1, M1	OM 69-0600	F7
OM 55-0961	O5	OM 59-0112	O19	OM 69-0326	D1, M1	OM 69-0618	D9
OM 55-0962	O5	OM 59-0113	O19	OM 69-0327	D1, M1	OM 69-0620	D9
OM 55-0963	O5	OM 59-0113E	O19	OM 69-0328	D1, M1	OM 69-0622	D9
OM 55-0964	O5	OM 59-0114	O19	OM 69-0340	D1, M1	OM 69-0623	D9
OM 55-0966	O5	OM 59-0115	O19	OM 69-0341	D1	OM 69-0625	D9
OM 55-0967	O5	OM 59-0115E	O19	OM 69-0342	D1	OM 69-0630	D9
OM 55-0972	O5	OM 59-0116	O19	OM 69-0343	D1	OM 69-0640	D9
OM 55-0973	O5	OM 59-011E6	O19	OM 69-0344	D1	OM 69-0645	D9
OM 55-0974	O5	OM 59-0121	O19	OM 69-0348	D5	OM 69-0650	D9
OM 55-0980	O16	OM 59-0121E	O19	OM 69-0352	D6	OM 69-0758	G8
OM 55-0981	O16	OM 59-0122	O19	OM 69-0380	D4	OM 69-0760	G8
OM 55-0990	N11	OM 59-0122E	O19	OM 69-0410	D5	OM 69-0762	G8
OM 55-0992	N11	OM 59-0123	O19	OM 69-0412	D5	OM 69-0764	G8
OM 57-0612	G1	OM 59-0124	O19	OM 69-0418	D4	OM 69-0766	G8
OM 57-0614	G1	OM 59-0125	O19	OM 69-0428	D3	OM 69-0785	L13
OM 57-0615	G2	OM 59-0126	O19	OM 69-0430	D3	OM 69-0787	L1
OM 57-0616	G1	OM 60-0110	M9	OM 69-0432	D3	OM 69-0790	D7
OM 57-0618	G2	OM 60-0185	S14b	OM 69-0434	D3	OM 69-0792	D5
OM 57-0620	G1	OM 61-0338	I51	OM 69-0438	D3	OM 69-0793	D5
OM 57-0622	G1	OM 61-0344	I51	OM 69-0440	D4	OM 69-0795	L1
OM 57-0624	G16	OM 59-0313	O19	OM 69-0441	D4	OM 69-0805	D6
OM 57-0626	G16	OM 59-0315	O19	OM 69-0442	D4	OM 69-0820	D6
OM 57-0628	G16	OM 59-0316	O19	OM 69-0445	D3	OM 69-0824	D6
OM 57-0630	G16	OM 59-0321	O19	OM 69-0446	D3	OM 69-0827	L2
OM 57-0632	G16	OM 59-0322	O19	OM 69-0448	D1	OM 69-0830	M8
OM 58-0050	F5	OM 60-0180	S14b	OM 69-0457	D8	OM 69-0832	M8
OM 58-0052	F5	OM 60-0185	S14b	OM 69-0459	D8	OM 69-0834	M8
OM 58-0060	F5	OM 60-0220	S24b	OM 69-0461	D8	OM 69-0836	M8
OM 58-0062	F5	OM 60-0230	S26	OM 69-0463	D8	OM 69-0838	M8

OM 69-0840	M8	OM 71-0121	R1	OM 71-0302	R1	OM 71-0682	R2
OM 69-0846	S29	OM 71-0122	R1	OM 71-0303	R1	OM 71-0683	R2
OM 69-0900	BB3	OM 71-0123	R1	OM 71-0304	R1	OM 71-0700	R2
OM 69-0901	BB3	OM 71-0124	R1	OM 71-0305	R1	OM 71-0703	R2
OM 69-0902	BB3	OM 71-0130	R1	OM 71-0307	R1	OM 71-0706	R2
OM 69-0905	BB11	OM 71-0131	R1	OM 71-0310	R1	OM 71-0709	R2
OM 69-0910	BB12	OM 71-0132	R1	OM 71-0311	R1	OM 71-0712	R2
OM 69-0915	BB13	OM 71-0133	R1	OM 71-0312	R1	OM 71-0715	R2
OM 69-0917	BB13	OM 71-0134	R1	OM 71-0313	R1	OM 71-0718	R2
OM 69-0930	D2	OM 71-0150	R1	OM 71-0314	R1	OM 71-0719	R2
OM 69-0932	D2	OM 71-0151	R1	OM 71-0315	R1	OM 71-0730	R2
OM 69-0940	J2	OM 71-0152	R1	OM 71-0450	R2	OM 71-0733	R2
OM 69-0946	J2	OM 71-0153	R1	OM 71-0453	R2	OM 71-0736	R2
OM 69-0950	J2	OM 71-0154	R1	OM 71-0456	R2	OM 71-0739	R2
OM 69-0970	J2	OM 71-0160	R1	OM 71-0459	R2	OM 71-0742	R2
OM 69-0975	J2	OM 71-0161	R1	OM 71-0462	R2	OM 71-0745	R2
OM 69-0980	K8	OM 71-0162	R1	OM 71-0465	R2	OM 71-0748	R2
OM 69-0980P	K8	OM 71-0163	R1	OM 71-0468	R2	OM 71-0749	R2
OM 69-0982	I4	OM 71-0164	R1	OM 71-0469	R2	OM 71-0750	R2
OM 69-0990	D12, I49	OM 71-0170	R1	OM 71-0480	R2	OM 71-0753	R2
OM 69-0998	D5	OM 71-0171	R1	OM 71-0483	R2	OM 71-0756	R2
OM 71-0001	S1	OM 71-0172	R1	OM 71-0486	R2	OM 71-0759	R2
OM 71-0002	S1	OM 71-0174	R1	OM 71-0489	R2	OM 71-0762	R2
OM 71-0003	S1	OM 71-0175	R1	OM 71-0492	R2	OM 71-0765	R2
OM 71-0004	S1	OM 71-0182	R1	OM 71-0495	R2	OM 71-0768	R2
OM 71-0006	S1	OM 71-0185	R1	OM 71-0498	R2	OM 71-0769	R2
OM 71-0008	R7, AA5	OM 71-0200	R1	OM 71-0510	R2	OM 71-0770	R2
OM 71-0009	R5, AA6	OM 71-0201	R1	OM 71-0513	R2	OM 71-0773	R2
OM 71-0010	R4, AA5	OM 71-0202	R1	OM 71-0516	R2	OM 71-0776	R2
OM 71-0011	R8, AA6	OM 71-0203	R1	OM 71-0519	R2	OM 71-0779	R2
OM 71-0012	S1	OM 71-0204	R1	OM 71-0522	R2	OM 71-0782	R2
OM 71-0013	S1	OM 71-0205	R1	OM 71-0525	R2	OM 71-0785	R2
OM 71-0014	S1	OM 71-0206	R1	OM 71-0528	R2	OM 71-0788	R2
OM 71-0016	S1	OM 71-0207	R1	OM 71-0529	R2	OM 71-0789	R2
OM 71-0017	S1	OM 71-0208	R1	OM 71-0600	R2	OM 71-0833	R3
OM 71-0019	S1	OM 71-0209	R1	OM 71-0603	R2	OM 71-0853	R3
OM 71-0021	R1	OM 71-0210	R1	OM 71-0606	R2	OM 71-0856	R3
OM 71-0022	R1	OM 71-0211	R1	OM 71-0609	R2	OM 71-0859	R3
OM 71-0023	R1	OM 71-0212	R1	OM 71-0612	R2	OM 71-0873	R3
OM 71-0024	R1	OM 71-0213	R1	OM 71-0615	R2	OM 71-0880	R2
OM 71-0025	R1	OM 71-0214	R1	OM 71-0618	R2	OM 71-0883	R2
OM 71-0030	R1	OM 71-0230	R1	OM 71-0619	R2	OM 71-0886	R2
OM 71-0031	R1	OM 71-0231	R1	OM 71-0630	R2	OM 71-0889	R2
OM 71-0032	R1	OM 71-0232	R1	OM 71-0633	R2	OM 71-0892	R2
OM 71-0033	R1	OM 71-0233	R1	OM 71-0636	R2	OM 71-0895	R2
OM 71-0034	R1	OM 71-0234	R1	OM 71-0639	R2	OM 71-0898	R2
OM 71-0100	R1	OM 71-0240	R1	OM 71-0642	R2	OM 72-0102	R3
OM 71-0101	R1	OM 71-0241	R1	OM 71-0645	R2	OM 72-0103	R3
OM 71-0102	R1	OM 71-0242	R1	OM 71-0648	R2	OM 72-0104	R3
OM 71-0103	R1	OM 71-0243	R1	OM 71-0660	R2	OM 72-0105	R3
OM 71-0104	R1	OM 71-0244	R1	OM 71-0663	R2	OM 72-0106	R3
OM 71-0105	R1	OM 71-0250	R1	OM 71-0666	R2	OM 72-0107	R3
OM 71-0106	R1	OM 71-0251	R1	OM 71-0669	R2	OM 72-0108	R3
OM 71-0107	R1	OM 71-0252	R1	OM 71-0672	R2	OM 72-0109	R3
OM 71-0108	R1	OM 71-0253	R1	OM 71-0674	R2	OM 72-0110	R3
OM 71-0109	R1	OM 71-0254	R1	OM 71-0675	R2	OM 72-0112	R3
OM 71-0110	R1	OM 71-0262	R1	OM 71-0676	R2	OM 72-0115	R3
OM 71-0111	R1	OM 71-0263	R1	OM 71-0677	R2	OM 72-0220	R3
OM 71-0112	R1	OM 71-0290	R1	OM 71-0678	R2	OM 72-0222	R3
OM 71-0113	R1	OM 71-0291	R1	OM 71-0679	R2	OM 72-0224	R3
OM 71-0114	R1	OM 71-0293	R1	OM 71-0680	R2	OM 72-0226	R3
OM 71-0120	R1	OM 71-0301	R1	OM 71-0681	R2	OM 72-0230	R3

OM 72-0300	R9	OM 76-0104	T16	OM 76-0048	T20	OM 80-0120	Q2
OM 72-0305	R9	OM 76-0105	T16	OM 76-0049	T20	OM 80-0125	Q2
OM 72-0330	R9	OM 76-0106	T16	OM 76-0050	T20	OM 80-0130	Q2
OM 72-0335	R9	OM 76-0107	T16	OM 76-0051	T20	OM 80-0135	Q2
OM 72-0338	R9	OM 76-0108	T16	OM 76-0052	T20	OM 80-0140	Q2
OM 72-0346	R9	OM 76-0082	T16	OM 76-0053	I20	OM 80-0145	Q2
OM 72-0360	R9	OM 76-0083	T16	OM 76-0054	I20	OM 80-0150	Q2
OM 72-0364	R9	OM 76-0084	T16	OM 76-0055	I20	OM 80-0155	Q2
OM 72-0366	R9	OM 76-0085	T16	OM 76-0056	I20	OM 80-0160	Q2
OM 73-0001	BB4	OM 76-0086	T16	OM 76-0058	I20	OM 80-0165	Q2
OM 73-0724	T8	OM 76-0087	T16	OM 76-0066	T20	OM 80-0170	Q2
OM 73-0813	T8	OM 76-0088	T16	OM 76-0067	T20	OM 80-0175	Q2
OM 76-0264	T12	OM 76-0089	T16	OM 76-0068	I20	OM 80-0180	Q2
OM 76-0266	T12	OM 76-0090	T16	OM 76-0069	I20	OM 80-0185	Q2
OM 76-0268	T12	OM 76-0091	T16	OM 76-0070	T20	OM 80-0190	Q2
OM 76-0270	T12	OM 76-0092	T16	OM 76-0071	I20	OM 80-0195	Q2
OM 76-0272	T12	OM 76-0163	T17	OM 76-0072	I20	OM 80-0200	Q2
OM 76-0262	T12	OM 76-0164	T17	OM 76-0073	T20	OM 80-0205	Q2
OM 76-0293	T11	OM 76-0165	T17	OM 76-0074	I20	OM 80-0210	Q2
OM 76-0294	T11	OM 76-0166	T17	OM 76-0075	I20	OM 80-0215	Q2
OM 76-0295	T11	OM 76-0168	T17	OM 76-0076	I20	OM 80-0220	Q2
OM 76-0296	T11	OM 76-0145	T17	OM 76-0078	I20	OM 80-0225	Q2
OM 76-0310	T11	OM 76-0146	T17	OM 80-0003	Q1	OM 80-0230	Q2
OM 76-0312	T11	OM 76-0204	T18	OM 80-0005	Q1	OM 80-0235	Q2
OM 76-0314	T11	OM 76-0205	T18	OM 80-0010	Q1	OM 80-0240	Q2
OM 76-0316	T11	OM 76-0206	T18	OM 80-0012	Q1	OM 80-0245	Q2
OM 76-0318	T11	OM 76-0224	T18	OM 80-0015	Q1	OM 80-0250	Q2
OM 76-0332	T13	OM 76-0226	T18	OM 80-0017	Q1	OM 80-0255	Q2
OM 76-0334	T13	OM 76-0002	T19	OM 80-0020	Q1	OM 80-0260	Q2
OM 76-0335	T13	OM 76-0003	T19	OM 80-0022	Q1	OM 80-0265	Q2
OM 76-0336	T13	OM 76-0004	T19	OM 80-0025	Q1	OM 80-0270	Q2
OM 76-0337	T13	OM 76-0005	T19	OM 80-0027	Q1	OM 80-0275	Q2
OM 76-0338	T13	OM 76-0006	T19	OM 80-0030	Q1	OM 80-0280	Q2
OM 76-0339	T13	OM 76-0007	T19	OM 80-0032	Q1	OM 80-0285	Q2
OM 76-0340	T13	OM 76-0008	T19	OM 80-0035	Q1	OM 80-0290	Q2
OM 76-0342	T13	OM 76-0009	T19	OM 80-0036	Q1	OM 80-0295	Q2
OM 76-0123	T13	OM 76-0010	T19	OM 80-0040	Q1	OM 80-0300	Q2
OM 76-0124	T13	OM 76-0011	T19	OM 80-0042	Q1	OM 80-0305	Q2
OM 76-0125	T13	OM 76-0012	T19	OM 80-0045	Q1	OM 80-0310	Q2
OM 76-0126	T13	OM 76-0013	T19	OM 80-0047	Q1	OM 80-0315	Q2
OM 76-0127	T13	OM 76-0014	T19	OM 80-0050	Q1	OM 80-0320	Q2
OM 76-0128	T13	OM 76-0015	T19	OM 80-0053	Q1	OM 80-0325	Q2
OM 76-0129	T13	OM 76-0016	T19	OM 80-0055	Q1	OM 80-0330	Q2
OM 76-0362	T14	OM 76-0017	T19	OM 80-0057	Q1	OM 80-0335	Q2
OM 76-0363	T14	OM 76-0018	T19	OM 80-0060	Q1	OM 80-0340	Q2
OM 76-0364	T14	OM 76-0022	T19	OM 80-0062	Q1	OM 80-0345	Q2
OM 76-0365	T14	OM 76-0023	T19	OM 80-0065	Q1	OM 80-0350	Q2
OM 76-0366	T14	OM 76-0024	T19	OM 80-0067	Q1	OM 80-0355	Q2
OM 76-0367	T14	OM 76-0025	T19	OM 80-0070	Q1	OM 80-0360	Q2
OM 76-0368	T14	OM 76-0026	T19	OM 80-0072	Q1	OM 80-0365	Q2
OM 76-0370	T14	OM 76-0027	T19	OM 80-0075	Q1	OM 80-0370	Q2
OM 76-0372	T14	OM 76-0028	T19	OM 80-0077	Q1	OM 80-0375	Q2
OM 76-0183	T14	OM 76-0029	T19	OM 80-0080	Q1	OM 80-0380	Q2
OM 76-0184	T14	OM 76-0030	T19	OM 80-0083	Q1	OM 80-0385	Q2
OM 76-0243	T15	OM 76-0031	T19	OM 80-0085	Q1	OM 80-0390	Q2
OM 76-0244	T15	OM 76-0032	T19	OM 80-0087	Q1	OM 80-0395	Q2
OM 76-0245	T15	OM 76-0033	T19	OM 80-0090	Q1	OM 80-0400	Q2
OM 76-0246	T15	OM 76-0034	T19	OM 80-0095	Q1	OM 80-0405	Q2
OM 76-0253	T15	OM 76-0035	T19	OM 80-0100	Q2	OM 80-0410	Q2
OM 76-0255	T15	OM 76-0036	T19	OM 80-0105	Q2	OM 80-0415	Q3
OM 76-0102	T16	OM 76-0046	T20	OM 80-0110	Q2	OM 80-0420	Q3
OM 76-0103	T16	OM 76-0047	T20	OM 80-0115	Q2	OM 80-0425	Q3

OM 80-0430	Q3	OM 80-0780	Q5	OM 81-0025	Y11	OM 81-0335	Y2
OM 80-0435	Q3	OM 80-0785	Q5	OM 81-0030	Y11	OM 81-0340	Y7
OM 80-0440	Q3	OM 80-0790	Q5	OM 81-0035	Y11	OM 81-0345	Y7
OM 80-0445	Q3	OM 80-0795	Q5	OM 81-0040	Y11	OM 81-0350	Y7
OM 80-0450	Q3	OM 80-0800	Q5	OM 81-0045	Y11	OM 81-0355	Y7
OM 80-0455	Q3	OM 80-0805	Q5	OM 81-0050	Y11	OM 81-0360	Y7
OM 80-0460	Q3	OM 80-0810	Q5	OM 81-0055	Y11	OM 81-0365	Y1
OM 80-0465	Q3	OM 80-0815	Q5	OM 81-0060	Y11	OM 82-0010	X1
OM 80-0470	Q3	OM 80-0820	Q5	OM 81-0065	Y11	OM 82-0015	X1
OM 80-0475	Q3	OM 80-0825	Q5	OM 81-0070	Y11	OM 82-0020	X1
OM 80-0480	Q3	OM 80-0830	Q5	OM 81-0075	Y11	OM 82-0025	X1
OM 80-0485	Q3	OM 80-0835	Q5	OM 81-0080	Y11	OM 82-0030	X1
OM 80-0490	Q3	OM 80-0840	Q5	OM 81-0085	Y11	OM 82-0031	X4
OM 80-0495	Q3	OM 80-0845	Q5	OM 81-0090	Y11	OM 82-0034	X3
OM 80-0500	Q3	OM 80-0850	Q5	OM 81-0095	Y11	OM 82-0033	I31a
OM 80-0505	Q3	OM 80-0855	Q5	OM 81-0100	Y10	OM 82-0035	X2
OM 80-0510	Q3	OM 80-0860	Q5	OM 81-0105	Y10	OM 82-0040	X2
OM 80-0515	Q3	OM 80-0865	Q6	OM 81-0110	Y10	OM 82-0045	X2
OM 80-0520	Q3	OM 80-0870	Q6	OM 81-0115	Y10	OM 82-0050	X2
OM 80-0525	Q3	OM 80-0875	Q6	OM 81-0120	Y10	OM 82-0055	X3
OM 80-0530	Q3	OM 80-0880	Q6	OM 81-0125	Y10	OM 82-0060	X3
OM 80-0535	Q3	OM 80-0885	Q7	OM 81-0130	Y10	OM 82-0065	X3
OM 80-0540	Q3	OM 80-0890	Q7	OM 81-0135	Y10	OM 82-0070	X3
OM 80-0545	Q3	OM 80-0895	Q7	OM 81-0140	Y10	OM 82-0075	X3
OM 80-0550	Q3	OM 80-0900	Q7	OM 81-0145	Y10	OM 82-0080	X4
OM 80-0555	Q3	OM 80-0902	Q7	OM 81-0150	Y10	OM 83-0010	Y8
OM 80-0560	Q3	OM 80-0904	Q7	OM 81-0155	Y10	OM 83-0015	Y8
OM 80-0565	Q3	OM 80-0906	Q7	OM 81-0160	Y10	OM 83-0020	Y8
OM 80-0570	Q3	OM 80-0908	Q7	OM 81-0165	Y10	OM 83-0025	Y8
OM 80-0575	Q3	OM 80-0910	Q7	OM 81-0170	Y10	OM 83-0030	Y8
OM 80-0580	Q3	OM 80-0912	Q7	OM 81-0175	Y10	OM 83-0035	Y8
OM 80-0585	Q3	OM 80-0914	Q7	OM 81-0180	Y10	OM 83-0040	Y8
OM 80-0590	Q3	OM 80-0916	Q7	OM 81-0185	Y10	OM 83-0045	Y8
OM 80-0595	Q4	OM 80-0918	Q7	OM 81-0190	Y10	OM 83-0050	Y8
OM 80-0600	Q4	OM 80-0920	Q7	OM 81-0195	Y1	OM 83-0055	Y8
OM 80-0605	Q4	OM 80-0922	Q7	OM 81-0200	Y1	OM 83-0060	Y8
OM 80-0610	Q4	OM 80-0924	Q7	OM 81-0205	Y1	OM 83-0065	Y8
OM 80-0615	Q4	OM 80-0926	Q7	OM 81-0210	Y1	OM 83-0070	Y8
OM 80-0620	Q4	OM 80-0928	Q7	OM 81-0215	Y1	OM 83-0075	Y8
OM 80-0625	Q4	OM 80-0930	Q7	OM 81-0220	Y1	OM 83-0080	Y8
OM 80-0630	Q4	OM 80-0932	Q7	OM 81-0225	Y1	OM 83-0085	Y8
OM 80-0635	Q4	OM 80-0934	Q8	OM 81-0230	Y1	OM 83-0112	Y9
OM 80-0640	Q4	OM 80-0936	Q8	OM 81-0235	Y1	OM 83-0114	Y9
OM 80-0645	Q4	OM 80-0938	Q8	OM 81-0240	Y2	OM 83-0116	Y9
OM 80-0650	Q4	OM 80-0940	Q8	OM 81-0245	Y2	OM 83-0420	Y12
OM 80-0655	Q4	OM 80-0942	Q8	OM 81-0250	Y2	OM 83-0422	Y12
OM 80-0660	Q4	OM 80-0944	Q8	OM 81-0255	Y2	OM 83-0423	Y12
OM 80-0665	Q4	OM 80-0946	Q8	OM 81-0260	Y2	OM 83-0424	Y12
OM 80-0670	Q4	OM 80-0948	Q8	OM 81-0265	Y2	OM 83-0430	Y12
OM 80-0675	Q4	OM 80-0950	Q8	OM 81-0270	Y2	OM 83-0432	Y12
OM 80-0680	Q4	OM 80-0952	Q8	OM 81-0275	Y2	OM 83-0434	Y12
OM 80-0685	Q4	OM 80-0954	Q8	OM 81-0280	Y2	OM 83-0436	Y12
OM 80-0690	Q4	OM 80-0956	Q8	OM 81-0285	Y2	OM 83-0440	Y12
OM 80-0695	Q4	OM 80-0958	Q8	OM 81-0290	Y2	OM 83-0442	Y12
OM 80-0700	Q4	OM 80-0960	Q8	OM 81-0295	Y2	OM 83-0444	Y12
OM 80-0705	Q4	OM 80-0962	Q8	OM 81-0300	Y2	OM 83-0445	Y12
OM 80-0710	Q4	OM 80-0964	Q8	OM 81-0305	Y2	OM 83-0446	Y12
OM 80-0715	Q4	OM 80-0966	Q8	OM 81-0310	Y2	OM 83-0448	Y12
OM 80-0720	Q4	OM 80-0968	Q8	OM 81-0315	Y2	OM 83-0600	Y3
OM 80-0725	Q4	OM 81-0010	Y11	OM 81-0320	Y2	OM 83-0700	Y3
OM 80-0730	Q4	OM 81-0015	Y11	OM 81-0325	Y2	OM 83-0800	Y3
OM 80-0775	Q5	OM 81-0020	Y11	OM 81-0330	Y2	OM 85-0006	U17

OM 85-0008	U17	OM 85-0325	U17	OM 90-0120	G12a	OM 93-0208	H10
OM 85-0010	U17	OM 85-0330	U17	OM 90-0125	G12a	OM 93-0209	H10
OM 85-0012	U17	OM 86-0005	I21	OM 90-0130	G12a	OM 93-0210	H10
OM 85-0014	U17	OM 86-0010	I21	OM 90-0135	G12a	OM 93-0211	H10
OM 85-0016	U17	OM 86-0015	I21	OM 90-0225	G12b	OM 93-0212	H10
OM 85-0018	U17	OM 86-0020	I22	OM 901790-01	P6	OM 93-0213	H10
OM 85-0020	U17	OM 86-0025	I22	OM 90 1790-02	P6	OM 93-0214	H10
OM 85-0022	U17	OM 86-0030	I22	OM 90 1790-03	P6	OM 94-0100	I52a
OM 85-0024	U17	OM 86-0035	I22	OM 90-1830	L6a	OM 96-0136	I52c
OM 85-0026	U17	OM 86-0040	I23	OM 90-1835	L6a	OM 96-0137	I52c
OM 85-0028	U17	OM 86-0045	I23	OM 90-1840	L6a	OM 96-0139	I52c
OM 85-0030	U17	OM 86-0050	I23	OM 90-1865	I59	OM 96-0140	I52c
OM 85-0032	U17	OM 86-0050	I22a	OM 90-1866	I59	OM 96-0142	I52c
OM 85-0034	U17	OM 86-0055	I23	OM 90-1875	I59	OM 96-0144	I52c
OM 85-0036	U17	OM 86-0055	I22a	OM 90-1876	I59	OM 96-0146	I52c
OM 85-0038	U17	OM 86-0060	I23	OM 90-1880	I59, D12	OM 96-0147	I52c
OM 85-0040	U17	OM 86-0060	I22a	OM 90-1881	I59, D12	OM 96-0148	I52d
OM 85-0042	U17	OM 86-0065	I23	OM 90-1883	P3	OM 96-0150	I52d
OM 85-0044	U17	OM 86-0065	I22a	OM 90-1884	P3	OM 96-0156	I52d
OM 85-0046	U17	OM 86-0070	I23	OM 90-1890-01	L2	OM 96-0157	I52d
OM 85-0048	U17	OM 86-0070	I22a	OM 90-1890-02	L2	OM 96-0158	I52d
OM 85-0050	U17	OM 86-0075	I23	OM 90-1890-XSM	L2	OM 96-0159	I52d
OM 85-0052	U17	OM 86-0075	I22a	OM 90-2820	X4	OM 96-0160	I52d
OM 85-0054	U17	OM 86-0080	I23	OM 90-3220-02	G10	OM 96-0162	I52d
OM 85-0056	U17	OM 86-0080	I22a	OM 90-3410	I31d	OM 96-0164	U12
OM 85-0058	U17	OM 86-0085	I23	OM 90-4210-SS	I35	OM 96-0169	I52
OM 85-0060	U17	OM 86-0085	I22a	OM 90-4210-SB	I35	OM 97-0260	G15
OM 85-0062	U17	OM 86-0090	I24	OM 90-4991	F8	OM 97-0261	G15
OM 85-0064	U17	OM 86-0095	I24	OM 90-5065	I60	OM 97-0262	G15
OM 85-0066	U17	OM 86-0098	I22a	OM 90-6130	I16	OM 97-0263	G15
OM 85-0068	U17	OM 86-0099	I22a	OM 90-6320	I17	OM 97-0264	G15
OM 85-0070	U17	OM 86-0100	I25	OM 90-6570	I31c	OM 97-0265	G15
OM 85-0072	U17	OM 86-0103	I22b	OM 90-6630	I31b	OM 97-0266	G15
OM 85-0100	S14	OM 86-0104	I22b	OM 90-7110	I31b,X4	OM 97-0267	G15
OM 85-0105	S14	OM 86-0105	I25	OM 90-7650-02	I18	OM 97-0268	G15
OM 85-0107	S14a	OM 86-0106	I22b	OM 90-8205	M9	OM 97-0269	G15
OM 85-0110	S14a	OM 86-0107	I22b	OM 91-0000-Set	L21	OM 97-0270	G15
OM 85-0200	U17	OM 86-0108	I22b	OM 91-0010	L21/L22	OM 97-0271	G15
OM 85-0205	U17	OM 86-0109	I22b	OM 91-0100	L21	OM 97-0272	G15
OM 85-0210	U17	OM 86-0110	I25	OM 91-0120	L22	OM 97-0273	G15
OM 85-0215	U17	OM 86-0115L	I31b	OM 91-0208	L21	OM 97-0274	G15
OM 85-0220	U17	OM 86-0120	I32	OM 91-0209	L21	OM 97-0276	G15
OM 85-0225	U17	OM 86-0120L	I31b, X4b	OM 91-0210	L21	OM 97-0277	G15
OM 85-0230	U17	OM 86-0125	I32	OM 91-0211	L21	OM 97-0278	G15
OM 85-0235	U17	OM 86-0129	I17	OM 91-0212	L21	OM 97-0279	G15
OM 85-0240	U17	OM 86-0130	I18	OM 91-0213	L21	OM 97-0310	I7
OM 85-0245	U17	OM 86-0132	G12b	OM 91-0215	L21	OM 97-0315	I7
OM 85-0250	U17	OM 86-0135	I18	OM 91-0220	L21	OM 97-0318	I7
OM 85-0255	U17	OM 86-0137	I18	OM 91-0500	I31d	OM 97-0320	I7
OM 85-0260	U17	OM 86-0140	I18	OM 93-0112	H10	OM 97-0322	I7
OM 85-0265	U17	OM 86-0145	I18	OM 93-0113	H10	OM 98-0150	AA2
OM 85-0270	U17	OM 86-0150	I32	OM 93-0114	H10	OM 98-0160	AA2
OM 85-0275	U17	OM 86-0155	I32	OM 93-0115	H10	OM 98-0170	AA2
OM 85-0280	U17	OM 86-0170	I31c	OM 93-0116	H10	OM 98-0180	AA1
OM 85-0285	U17	OM 86-0172	I31c	OM 93-0117	H10	OM 98-0190	AA1
OM 85-0290	U17	OM 89-0310	Q10	OM 93-0118	H10	OM 98-0195	AA1
OM 85-0295	U17	OM 89-0313	Q10	OM 93-0119	H10	OM 99-0001	H11
OM 85-0300	U17	OM 89-0316	Q10	OM 93-0125	H10	OM 99-0002	H11
OM 85-0305	U17	OM 89-0318	Q10	OM 93-0127	H10	OM 99-0003	H11
OM 85-0310	U17	OM 89-0319	Q10	OM 93-0205	H10	OM 99-0004	H11
OM 85-0315	U17	OM 90-0110	G12a	OM 93-0206	H10	OM 99-0005	H11
OM 85-0320	U17	OM 90-0115	G12a	OM 93-0207	H10	OM 99-0006	H11

OM 99-0007	H11	OM 99-0308	H12	OM MA 110-685	I53	OM NL9702-030	I62
OM 99-0008	H11	OM 99-0309	H12	OM MA 110-686	I53	OM NL9702-031	I62
OM 99-0009	H11	OM 99-0310	H12	OM MA 110-687	I53	OM NL9702-032	I62
OM 99-0010	H11	OM 99-0311	H12	OM MA 110-688	I53	OM NL9702-033	I62
OM 99-0011	H11	OM 99-0312	H12	OM MA 110-689	I53	OM NL9702-034	I62
OM 99-0012	H11	OM ATH 0120133	Q6	OM MA 110-690	I53	OM NL9702-035	I62
OM 99-0013	H11	OM BR-3050	Y5	OM MA 110-711	I55-I56	OM NL9702-036	I62
OM 99-0014	H11	OM BR-3100	Y5	OM MA 110-713	I55-I56	OM NL9702-040	I62
OM 99-0015	H11	OM BR-3110	Y5	OM MA 110-715	I55-I56	OM NL9702-041	I62
OM 99-0016	H11	OM BR-3125	Y5	OM MA 110-716	I56	OM NL9702-042	I62
OM 99-0017	H11	OM BR-3113	Y5	OM MA 110-717	I55-I56	OM NL9702-043	I62
OM 99-0018	H11	OM BR-3114	Y5	OM MA 110-719	I55	OM NL9702-044	I62
OM 99-0019	H11	OM BR-3115	Y5	OM MA 110-721	I55,I57	OM N L9702-045	I62
OM 99-0020	H11	OM BR-3120	Y5	OM MA 110-723	I55,I57	OM PS00 991-02	H9
OM 99-0021	H11	OM BR-3130	Y5	OM MA 110-725	I55,I57	OM PS00 991-03	H9
OM 99-0022	H11	OM BR-3137	Y5	OM MA 110-727	I55-I56	OM PS00 991-04	H9
OM 99-0023	H11	OM BR-3140	Y5	OM MA 110-729	I55-I56	OM PS00 991-05	H9
OM 99-0024	H11	OM BR-3142	Y5	OM MA 110-731	I55	OM PS00 991-06	H9
OM 99-0030	H11	OM BR-3143	Y5	OM MA 110-733	I55	OM PS00 991-07	H9
OM 99-0031	H11	OM BR-3144	Y5	OM MA 110-735	I55	OM PS00 991-08	H9
OM 99-0032	H11	OM BR-3145	Y5	OM MA 110-737	I55,I57	OM PS00 991-09	H9
OM 99-0033	H11	OM BR-3150	Y5	OM MA 110-739	I55	OM PW-43	Y6
OM 99-0034	H11	OM BR-3153	Y5	OM MA 110-741	I55-I56	OM PW-43-2	Y6
OM 99-0035	H11	OM BR-3155	Y5	OM MA 110-743	I55	OM PW-63	Y6
OM 99-0036	H11	OM BR-3170	Y5	OM MA 110-746	I55,I57	OM PW-63-2	Y6
OM 99-0037	H11	OM BR-3173	Y5	OM MA 110-760	I55	OM PW-952	Y6
OM 99-0038	H11	OM BR-3175	Y5	OM MA 110-770	I55	OM PW-953	Y6
OM 99-0039	H11	OM BR-3160	Y5	OM MA 110-811	I57	OM PW-952-2	Y6
OM 99-0040	H11	OM BR-3165	Y5	OM MA 110-812	I57	OM PW-1002	Y6
OM 99-0041	H11	OM BR-2300	Y5	OM MA 110-813	I57	OM PW-1002-2	Y6
OM 99-0042	H11	OM BR-4100	Y5	OM MA 110-814	I57	OM PW-1202	Y6
OM 99-0043	H11	OM BR-4140	Y5	OM MA 110-815	I57	OM PW-1202-2	Y6
OM 99-0044	H11	OM CK-10	A37	OM MA 110-816	I57	OM PW-E1082	Y6
OM 99-0045	H11	OM CK-40	A37	OM MA 110-817	I57	OM PW-E1084	Y6
OM 99-0046	H11	OM DP2581-00	I31b	OM MA 110-818	I57	OM PW-E1082-2	Y6
OM 99-0047	H11	OM EM1010	I8	OM MA 110-819	I57	OM PW-E1650	Y6
OM 99-0048	H11	OM JR-C10	R4	OM MA 110-820	I57	OM PW-E1654	Y6
OM 99-0049	H11	OM JR-050	R4	OM MA 110-821	I57	OM PW-1650-2	Y6
OM 99-0050	H11	OM JR-S200	R4	OM MA 110-822	I57	OM PW-E902	Y6
OM 99-0051	H11	OM JR-W028	R4	OM MA 110-823	I57	OM PW-904	Y6
OM 99-0052	H11	OM JR-W028-RD	R4	OM MA 110-834	I57	OM PW-902-2	Y6
OM 99-0053	H11	OM JR-W035	R4	OM MA 110-836	I57	OM PW-E2302	Y6
OM 99-0060	H11	OM JR-W035-DB	R4	OM MA 110-837	I57	OM PW-E2304	Y6
OM 99-0061	H11	OM JR-W045	R4	OM MA 110-848	I57	OM PW-E2306	Y6
OM 99-0062	H11	OM JR-W045-YL	R4	OM MX 5-700	A14	OM PW-2302-2	Y6
OM 99-0063	H11	OM JR-W062	R4	OM MX 5-702	A14	OM PW-E06062	Y6
OM 99-0064	H11	OM JR-W062-GN	R4	OM NL9701	I61,I62	OM PW-E06064	Y6
OM 99-0065	H11	OM JR-W564	R4	OM NL9701-H	I61,I62	OM PW-E06066	Y6
OM 99-0066	H11	OM JR-W564-BL	R4	OM NL9702-H	I61	OM PW-602-2	Y6
OM 99-0067	H11	OM JR-W332	R4	OM NL9702-01	I61	OM PW-E10062	Y6
OM 99-0068	H11	OM JR-W332-CR	R4	OM NL9702-010	I62	OM PW-E10064	Y6
OM 99-0069	H11	OM KO 7248-38	I52	OM NL9702-01 1	I62	OM PW-E10066	Y6
OM 99-0070	H11	OM KO 7248-40	I52	OM NL9702-012	I61	OM PW-402-2	Y6
OM 99-0071	H11	OM KO 7248-50	I52	OM NL9702-013	I61	OM PW-10F	Y7
OM 99-0300	H12	OM MA 110-671	I54	OM NL9702-014	I61	OM PW-13F	Y7
OM 99-0301	H12	OM MA 110-672	I54	OM NL9702-015	I62	OM PW-15F	Y7
OM 99-0302	H12	OM MA 110-673	I54	OM NL9702-021	I61	OM PW-17F	Y7
OM 99-0303	H12	OM MA 110-674	I54	OM NL9702-022	I61	OM PW-19F	Y7
OM 99-0304	H12	OM MA 110-681	I53	OM NL9702-023	I61	OM PW-1520	Y7
OM 99-0305	H12	OM MA 110-682	I53	OM NL9702-024	I61	OM PW-1525	Y7
OM 99-0306	H12	OM MA 110-683	I53	OM NL9702-025	I62	OM PW-E12101	Y7
OM 99-0307	H12	OM MA 110-684	I53	OM NL9702-026	I62	OM PW-E20121	Y7

OM PW-12A	Y8	OM SYN202832	T9	OM SYN204910	T10	OM SYN211008	T3
OM PW-18A	Y8	OM SYN202834	T9	OM SYN206010	T5	OM SYN211010	T3
OM PW-22A	Y8	OM SYN202840	T9	OM SYN206012	T5	OM SYN211012	T3
OM PW-26A	Y8	OM SYN204010	T4	OM SYN206014	T5	OM SYN211014	T3
OM PW-30A	Y8	OM SYN204012	T4	OM SYN206016	T5	OM SYN211016	T3
OM PW-32A	Y8	OM SYN204014	T4	OM SYN206018	T5	OM SYN211018	T3
OM PW-40A	Y8	OM SYN204016	T4	OM SYN206020	T5	OM SYN211020	T3
OM PW-6G	Y8	OM SYN204018	T4	OM SYN206022	T5	OM SYN211022	T3
OM PW-14G	Y8	OM SYN204020	T4	OM SYN206024	T5	OM SYN211024	T3
OM PW-2	Y8	OM SYN204022	T4	OM SYN206026	T5	OM SYN211026	T3
OM QA LCB	Y4	OM SYN204024	T4	OM SYN206028	T5	OM SYN211028	T3
OM QA MCB	Y4	OM SYN204026	T4	OM SYN206030	T5	OM SYN211030	T3
OM QA SCB	Y4	OM SYN204028	T4	OM SYN206032	T5	OM SYN211032	T3
OM QA ST10-1.5	Y4	OM SYN204030	T4	OM SYN206035	T5	OM SYN211034	T3
OM QA ST10-2.5	Y4	OM SYN204032	T4	OM SYN206040	T5	OM SYN211036	T3
OM QA ST7-2-9-2mm	Y4	OM SYN204034	T4	OM SYN206045	T5	OM SYN211038	T3
OM QA ST10-3.0	Y4	OM SYN204036	T4	OM SYN206050	T5	OM SYN211806	T9
OM QA XLCB	Y4	OM SYN204038	T4	OM SYN206055	T5	OM SYN211808	T9
OM QA XSB	Y4	OM SYN204040	T4	OM SYN206060	T5	OM SYN211810	T9
OM RD 11-1142	H10	OM SYN204045	T4	OM SYN206065	T5	OM SYN211812	T9
OM RD 11-1143	H10	OM SYN204050	T4	OM SYN206070	T5	OM SYN211814	T9
OM RD 11-1144	H10	OM SYN204055	T4	OM SYN206075	T5	OM SYN211816	T9
OM RD 11-1145	H10	OM SYN204060	T4	OM SYN207010	T5	OM SYN211818	T9
OM RD 11-1146	H10	OM SYN204065	T4	OM SYN207012	T5	OM SYN211820	T9
OM RD 11-1147	H10	OM SYN204070	T4	OM SYN207014	T5	OM SYN211822	T9
OM RW4849	P6	OM SYN204075	T4	OM SYN207016	T5	OM SYN211824	T9
OM RW8800	P6	OM SYN204080	T4	OM SYN207018	T5	OM SYN211826	T9
OM SET 54-09-25-000	U26	OM SYN204085	T4	OM SYN207020	T5	OM SYN211828	T9
OM SET 54-09-25-000	U27	OM SYN204090	T4	OM SYN207022	T5	OM SYN211830	T9
OM SET 54-09-25-0000-31	U26	OM SYN204095	T4	OM SYN207024	T5	OM SYN211832	T9
OM SP-1066	I31d	OM SYN204100	T4	OM SYN207026	T5	OM SYN211834	T9
OM SYN202006	T4	OM SYN204105	T4	OM SYN207028	T5	OM SYN211836	T9
OM SYN202008	T4	OM SYN204110	T4	OM SYN207030	T5	OM SYN211838	T9
OM SYN202010	T4	OM SYN204810	T10	OM SYN207035	T5	OM SYN211840	T9
OM SYN202012	T4	OM SYN204812	T10	OM SYN207040	T5	OM SYN214014	T6
OM SYN202014	T4	OM SYN204814	T10	OM SYN207045	T5	OM SYN214016	T6
OM SYN202016	T4	OM SYN204816	T10	OM SYN207050	T5	OM SYN214018	T6
OM SYN202018	T4	OM SYN204818	T10	OM SYN207055	T5	OM SYN214020	T6
OM SYN202020	T4	OM SYN204820	T10	OM SYN207060	T5	OM SYN214022	T6
OM SYN202022	T4	OM SYN204822	T10	OM SYN210006	T3	OM SYN214024	T6
OM SYN202024	T4	OM SYN204824	T10	OM SYN210007	T3	OM SYN214026	T6
OM SYN202026	T4	OM SYN204826	T10	OM SYN210008	T3	OM SYN214028	T6
OM SYN202028	T4	OM SYN204828	T10	OM SYN210009	T3	OM SYN214030	T6
OM SYN202030	T4	OM SYN204830	T10	OM SYN210010	T3	OM SYN214032	T6
OM SYN202032	T4	OM SYN204832	T10	OM SYN210011	T3	OM SYN214034	T6
OM SYN202034	T4	OM SYN204834	T10	OM SYN210012	T3	OM SYN214036	T6
OM SYN202036	T4	OM SYN204836	T10	OM SYN210014	T3	OM SYN214038	T6
OM SYN202038	T4	OM SYN204838	T10	OM SYN210016	T3	OM SYN214040	T6
OM SYN202040	T4	OM SYN204840	T10	OM SYN210018	T3	OM SYN214042	T6
OM SYN202806	T9	OM SYN204845	T10	OM SYN210020	T3	OM SYN214044	T6
OM SYN202808	T9	OM SYN204850	T10	OM SYN210806	T8	OM SYN214046	T6
OM SYN202810	T9	OM SYN204855	T10	OM SYN210807	T8	OM SYN214048	T6
OM SYN202812	T9	OM SYN204860	T10	OM SYN210808	T8	OM SYN214050	T6
OM SYN202814	T9	OM SYN204865	T10	OM SYN210809	T8	OM SYN214052	T6
OM SYN202816	T9	OM SYN204870	T10	OM SYN210810	T8	OM SYN214054	T6
OM SYN202818	T9	OM SYN204875	T10	OM SYN210811	T8	OM SYN214056	T6
OM SYN202820	T9	OM SYN204880	T10	OM SYN210812	T8	OM SYN214814	T10
OM SYN202822	T9	OM SYN204885	T10	OM SYN210814	T8	OM SYN214816	T10
OM SYN202824	T9	OM SYN204890	T10	OM SYN210816	T8	OM SYN214818	T10
OM SYN202826	T9	OM SYN204895	T10	OM SYN210818	T8	OM SYN214820	T10
OM SYN202828	T9	OM SYN204900	T10	OM SYN210820	T8	OM SYN214822	T10
OM SYN202830	T9	OM SYN204905	T10	OM SYN211006	T3	OM SYN214824	T10

OM SYN214826	T10	OM SYN217100	T7
OM SYN214828	T10	OM SYN217105	T7
OM SYN214830	T10	OM SYN217110	T7
OM SYN214832	T10	OM SYN217115	T7
OM SYN214834	T10	OM SYN310.23	U1
OM SYN214836	T10	OM SYN310.66	U2
OM SYN214838	T10	OM SYN310.67	U2
OM SYN214840	T10	OM SYN310.68	U2
OM SYN214842	T10	OM SYN310510	U1
OM SYN214844	T10	OM SYN 314467	U11
OM SYN214846	T10	OM SYN 314116	U11
OM SYN214848	T10	OMSYN 314119	U11
OM SYN214850	T10	OM TO 579-260-00	Q10
OM SYN214852	T10	OM TO 579-260-01	Q10
OM SYN214854	T10	OM TO 579-260-02	Q10
OM SYN214856	T10	OM TO 579-260-03	Q10
OM SYN214858	T10	OM TO 579-270-00	Q10
OM SYN214860	T10	OM TO 579-270-01	Q10
OM SYN214862	T10	OM TO 579-270-02	Q10
OM SYN214864	T10	OM TO 579-270-03	Q10
OM SYN214866	T10	OM W45-233	H5
OM SYN214868	T10	OM W45-234	H5
OM SYN214870	T10	OM W45-235	H5
OM SYN215025	T6	OM SYN217120	T7
OM SYN215030	T6	OM SYN217125	T7
OM SYN215035	T6	OM SYN217130	T7
OM SYN215040	T6	OM SYN217135	T7
OM SYN215045	T6	OM SYN217140	T7
OM SYN215050	T6	OM SYN217145	T7
OM SYN215055	T6	OM SYN217150	T7
OM SYN215060	T6	OM SYN218020	T8
OM SYN215065	T6	OM SYN218025	T8
OM SYN215070	T6	OM SYN218030	T8
OM SYN216030	T7	OM SYN218035	T8
OM SYN216035	T7	OM SYN218040	T8
OM SYN216035	T7	OM SYN218045	T8
OM SYN216040	T7	OM SYN218050	T8
OM SYN216045	T7	OM SYN218055	T8
OM SYN216050	T7	OM SYN218060	T8
OM SYN216055	T7	OM SYN218065	T8
OM SYN216060	T7	OM SYN218070	T8
OM SYN216065	T7	OM SYN218075	T8
OM SYN216070	T7	OM SYN218080	T8
OM SYN216075	T7	OM SYN218085	T8
OM SYN216080	T7	OM SYN218090	T8
OM SYN216085	T7	OM SYN218095	T8
OM SYN216090	T7	OM SYN218100	T8
OM SYN216095	T7	OM SYN218105	T8
OM SYN216100	T7	OM SYN218110	T8
OM SYN216105	T7	OM SYN310.65	U2
OM SYN216110	T7		
OM SYN217045	T7		
OM SYN217050	T7		
OM SYN217055	T7		
OM SYN217060	T7		
OM SYN217065	T7		
OM SYN217070	T7		
OM SYN217075	T7		
OM SYN217080	T7		
OM SYN217085	T7		
OM SYN217090	T7		
OM SYN217095	T7		