

# MALLETS, TAMPS AND IMPACTORS



Mallets exert force on osteotomes, chisels and gouges.  
Tamps wedge bone graft into place.

## SECTION K

### CONTENTS

Mallets	1-6
Tamps	7-8
Impactors and Drivers	8-9



OM 49-0765  
 7" (178mm)  
 solid stainless steel  
 weight: 4 oz. (120 grams)  
 head weight: 3 oz. (80 grams)  
 head diameter: 20mm

MINI Mallet



OM 49-0761  
 7 1/2" (191mm)  
 solid stainless steel  
 weight: 7 oz. (200 grams)  
 head weight: 3 oz. (80 grams)  
 head diameter: 19mm

OM 46-0660  
 8" (203mm)  
 brass head  
 stainless steel handle  
 weight: 9 oz. (260 grams)  
 head weight: 5 oz. (150 grams)  
 head diameter: 25mm

LUCAE BONE Mallet

**NOTE:** Lead filled mallets should only be used to strike flat surfaces.  
 Do not use to hit sharp objects as doing so can cause lead to flake off.



OM 46-0656  
 7 3/4" (195mm)  
 lead filled and faced  
 weight: 7 oz. (200 grams)  
 head weight: 5 oz. (150 grams)  
 head diameter: 22mm

Mallet # 49

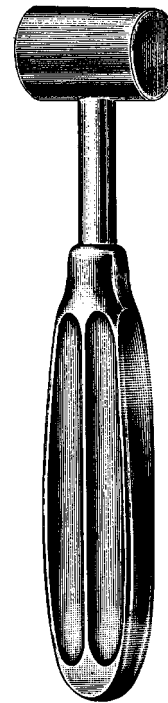

OM 46-0661  
 7 1/2" (191mm)  
 lead filled and faced  
 weight: 10 oz. (285 grams)  
 head weight: 7 oz. (200 grams)  
 head diameter: 25mm

GERZOG BONE Mallet

# MALLETS



*Useful for hand surgery and in areas where access is limited.*

*Autoclavable to 290° F (143° C).*

OM 49-0764  
8" (203mm)  
with phenolic handle  
weight: 7 oz. (200 grams)  
head weight: 3 oz. (80 grams)  
head diameter: 18mm x 18mm  
(square contact surface)  
7mm (round contact surface)

**NARROW TIP MALLET**



OM 49-0760  
8" (203mm)  
solid stainless steel  
weight: 7 oz. (200 grams)  
head weight: 5 oz. (150 grams)  
head diameter: 30mm

**COLLIN MALLET**

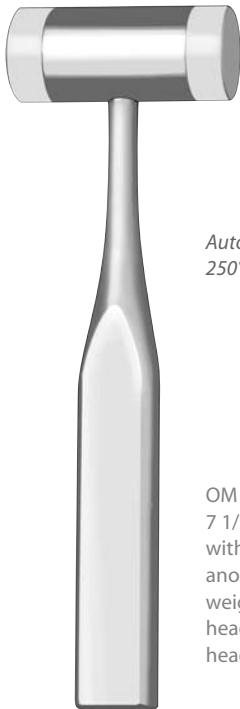

*Autoclavable to 250° F (121° C).*

OM 46-0662  
7 1/2" (191mm)  
with two replaceable nylon caps  
anodized aluminum handle  
weight: 7 oz. (200 grams)  
head weight: 4 oz. (120 grams)  
head diameter: 25mm

**MALLET**  
Lightweight

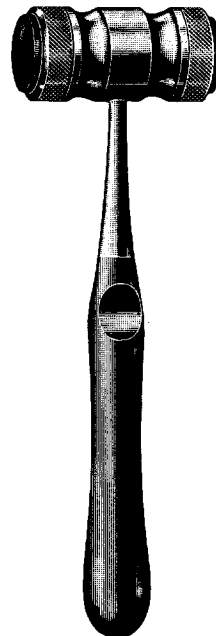

*Autoclavable to 250° F (121° C).*

OM 46-0657  
7 1/2" (191mm)  
with replaceable nylon caps  
weight: 11 oz. (315 grams)  
head weight: 6 oz. (170 grams)  
head diameter: 20mm

**MEAD MALLET**

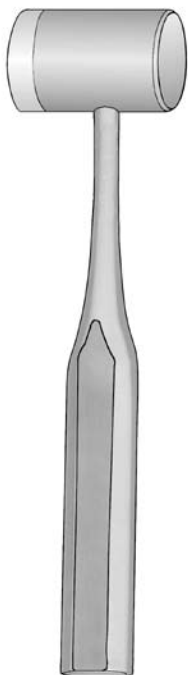

*Autoclavable to  
250° F (121° C).*

OM 46-0686  
7 1/2" (191mm)  
weight: 9 oz. (260 grams)  
head weight: 5 oz. (150 grams)  
head diameter: 26mm

OM 46-0687  
7 1/2" (191mm)  
weight: 12 oz. (340 grams)  
head weight: 8 oz. (240 grams)  
head diameter: 30mm

**COMBINATION Mallet**

With one nylon cap and one solid stainless side



OM 55-0400  
7 1/2" (191mm)  
weight: 8 oz. (240 grams)  
head weight: 4 oz. (120 grams)  
head diameter: 19mm  
ball peen diameter: 16mm

OM 55-0401  
9" (229mm)  
weight: 1 lb. (450 grams)  
head weight: 8 oz. (240 grams)  
head diameter: 25mm  
ball peen diameter: 22mm

**CLOWARD-STYLE Mallet**

Solid stainless steel



OM 49-0763  
7" (178mm)  
solid stainless steel  
weight: 1 lb. 2 oz. (500 grams)  
head weight: 8 oz. (240 grams)  
head diameter: 30mm

**ORTHOPEDIC Mallet**

Short handle, lightweight

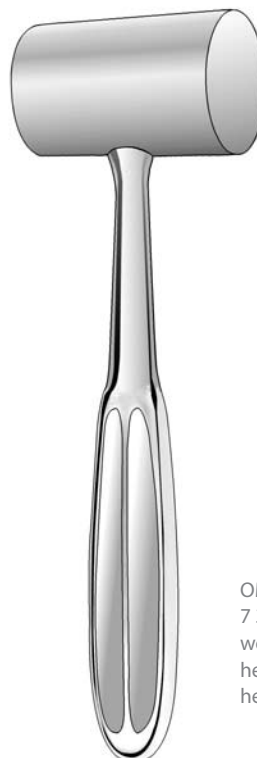

*Head is brass filled  
and should only be  
used to strike flat  
surfaces.*

OM 46-0658  
7 3/4" (195mm)  
weight: 1 lb. 7 oz. (650 grams)  
head weight: 1 lb. 4 oz. (570 grams)  
head diameter: 38mm

**KIRK Mallet**

# MALLETS



OM 49-0762  
7 1/2" (191mm)  
solid stainless steel  
weight:  
2 lbs. (900 grams)  
head weight:  
1 lb 5 oz. (600 grams)  
head diameter: 38mm

**ORTHOPEDIC MALLET**  
Heavyweight, short handle



OM 49-0766  
9" (229mm)  
aluminum alloy handle  
weight:  
15 oz. (420 grams)  
head weight:  
9 oz. (260 grams)  
head diameter: 30mm

**BERGMAN MALLET**



OM 49-0767  
9 1/2" (241mm)  
aluminum alloy handle  
weight:  
1 lb. 1 oz. (470 grams)  
head weight:  
11 oz. (310 grams)  
head diameter: 45mm

**BERGMAN MALLET**



OM 46-0663  
7 1/2" (191mm)  
solid stainless steel  
weight: 2 lbs. (900 grams)  
head weight: 1 lb. 4 oz. (570 grams)  
head diameter: 40mm

**HEATH MALLET**  
Heavyweight



*Also know as dead  
blow mallet.*

*Grooved phenolic handle  
for comfortable grip.  
Autoclavable to 250° F (121° C).*

OM 46-0690  
11 1/2" (292mm)  
weight: 1 lb. 5 oz. (600 grams)  
head weight: 10 oz. (285 grams)  
head diameter: 32mm  
dead blow mallet with phenolic  
handle, one nylon cap and one  
stainless steel side

**REPROCUSSION FREE MALLET**



OM 46-0667  
10 1/2" (267mm)  
solid stainless steel  
weight: 3 lbs. (1360 grams)  
head weight: 2 lbs. (900 grams)  
head diameter: 48mm

**ORTHOPEDIC MALLET**  
Heavyweight



*Grooved phenolic handle  
for comfortable and safe grip.  
Autoclavable to 290° F (143° C).*

OM 46-0688  
10" (254mm)  
weight: 1 lb. 11 oz. (765 grams)  
head weight: 1 lb. (455 grams)  
head diameter: 35mm

**PHENOLIC HANDLE MALLET**



OM 46-0666  
10 3/4" (273mm)  
solid stainless steel  
weight: 2 lbs. (900 grams)  
head weight: 1 lb. (455 grams)  
head diameter: 32mm

**ORTHOPEDIC MALLET**  
Lightweight

# MALLETS



*Grooved phenolic handle for comfortable and safe grip. Autoclavable to 290°F (143°C).*

OM 46-0689  
11" (280mm)  
weight: 2 lbs. 9 oz. (1160 grams)  
head weight: 2 lbs. (900 grams)  
head diameter: 45mm

**PHENOLIC HANDLE Mallet**



OM 49-0770  
9 3/4" (248mm)

**WAGNER Mallet**



OM 49-0771  
1 pair of metal disks



OM 49-0772  
1 pair of plastic disks



OM 49-0773  
wrench

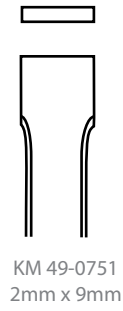

KM 49-0751  
2mm x 9mm

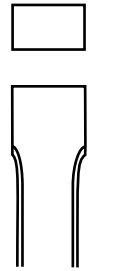

KM 49-0752  
6mm x 9mm

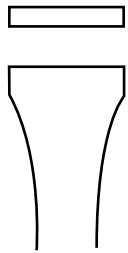

KM 49-0750  
3mm x 16mm

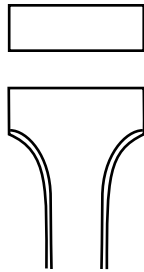

KM 49-0753  
6mm x 19mm

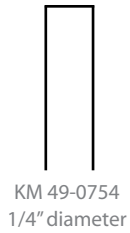

KM 49-0754  
1/4" diameter

**BONE CHIP PACKER**  
10" (254mm)

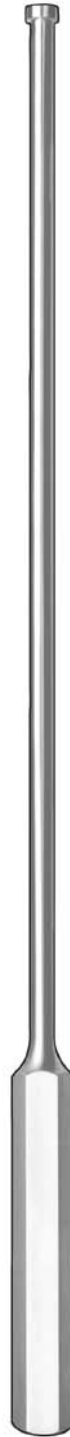

OM 55-0676  
17" (432mm)  
stainless steel handle  
3/8" diameter  
.16" tip length  
12.59" shaft length  
4 1/4" handle length  
.280" (7.1mm) shaft diameter

**BONE TAMP**  
Endoscopic

# TAMPS AND IMPACTORS

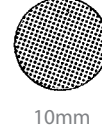
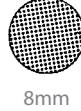

- OM 46-0893 2mm diameter
- OM 46-0894 3mm diameter
- OM 46-0895 4mm diameter
- OM 46-0896 5mm diameter
- OM 46-0897 6mm diameter
- OM 46-0898 8mm diameter
- OM 46-0899 10mm diameter

**BONE TAMP**  
With cross serrated tip  
6" (152mm)

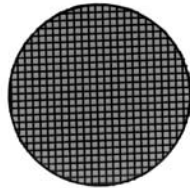

OM 69-0980P  
replaceable nylon cap

*Designed to tap bone graft or bone parts into place with minimal trauma to the bone. The compactor head is nylon with a grid surface to prevent slippage.*

*Autoclavable to 250° (121°C).*

OM 69-0980  
6 1/2" (165mm)  
with replaceable nylon caps  
anodized aluminum handle  
head diameter: 20mm

**BONE IMPACTOR**

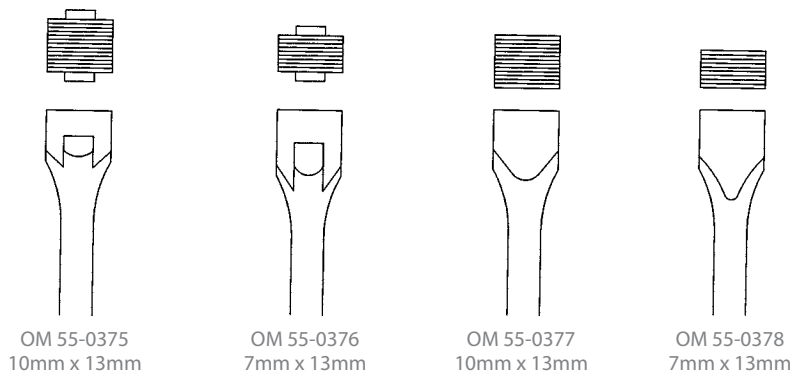
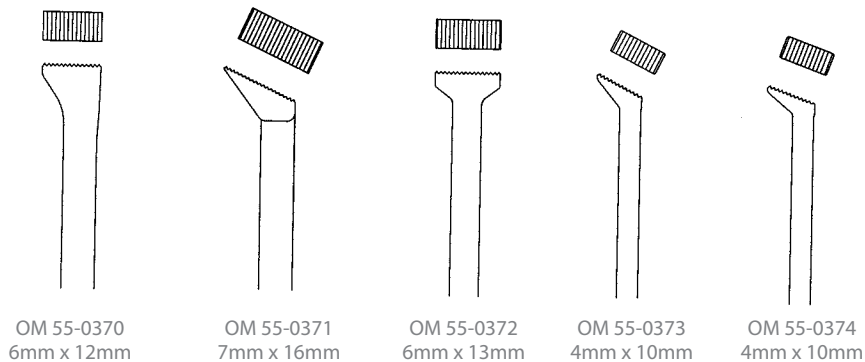

OM 55-0370	8 1/2"	Impactor, standard offset
OM 55-0371	8 1/2"	Impactor, central canal
OM 55-0372	8 1/2"	Impactor, lateral narrow
OM 55-0373	7"	Impactor, micro offset
OM 55-0374	7"	Impactor, micro lateral
OM 55-0375	8 1/2"	Graft Driver, lumbar, guarded
OM 55-0376	8 1/2"	Graft Driver, anterior, guarded
OM 55-0377	8 1/2"	Graft Driver, lumbar, unguarded
OM 55-0378	8 1/2"	Graft Driver, anterior, unguarded

**LUMBAR AND CERVICAL IMPACTORS AND DRIVERS**  
Serrated tips